Amended Safety Assessment of Silicates as Used in Cosmetics

Status: Draft Tentative Amended Report for Panel Review
Release Date: February 16, 2021
Panel Meeting Date: March 11-12, 2021

The Expert Panel for Cosmetic Ingredient Safety members are: Chair, Wilma F. Bergfeld, M.D., F.A.C.P.; Donald V. Belsito, M.D.; David E. Cohen, M.D.; Curtis D. Klaassen, Ph.D.; Daniel C. Liebler, Ph.D.; Lisa A. Peterson, Ph.D.; Ronald C. Shank, Ph.D.; Thomas J. Slaga, Ph.D.; and Paul W. Snyder, D.V.M., Ph.D. Previous Panel member involved in this assessment: James G. Marks, Jr., M.D. The Cosmetic Ingredient Review (CIR) Executive Director is Bart Heldreth, Ph.D. This safety assessment was prepared by Christina L. Burnett, Senior Scientific Analyst/Writer, CIR.

Commitment & Credibility since 1976

Memorandum

To: Expert Panel for Cosmetic Ingredient Safety Members and Liaisons
From: Christina L. Burnett, Senior Scientific Analyst/Writer, CIR
Date: February 16, 2021
Subject: Amended Safety Assessment of Silicates as Used in Cosmetics

Enclosed is the Draft Tentative Amended Report on the Amended Safety Assessment of Silicates as Used in Cosmetics. (It is identified as *silsal032021rep* in the pdf document). At the September 2020 meeting, the Panel issued an Insufficient Data Announcement (IDA) for these ingredients. The additional data needed to determine safety were:

- Method of manufacturing, with specific focus to the origin of raw materials (synthetic versus mined derivation)
- Composition and impurities data, specifically percent quantification of any crystalline silica/silicate
- Inhalation toxicity data

Since the issuance of the IDA, CIR has received unpublished data on composition and impurities for Magnesium Aluminum Silicate and Sodium Magnesium Silicate and crystallinity content for Aluminum Calcium Sodium Silicate and Sodium Silver Aluminum Silicate (*silsal032021data1* through *silsal032021data5*). These data have been incorporated into the report and are highlighted to aid in the Panel's review. Additionally, inhalation toxicity summary data and the conclusion from the synthetically-derived amorphous silica and hydrated silica report, regulatory standards for OSHA and NIOSH, and findings from the ATSDR report on silica have been incorporated and highlighted.

The CIR Science and Support Committee has provided comments (*silsal032021CIR_SSC*), primarily with regard to the discussion of crystalline silica as a potential contaminant. Correspondence from the Synthetic Amorphous Silica and Silicate Industry Association (SASSI) regarding the Draft Amended Report are also included in this report package (*silsal032021SASSI*). SASSI stated they have no additional data to submit related to the three silicates manufactured by SASSI member companies for use in cosmetics, and reiterated their statement that only Calcium Silicate, Sodium Metasilicate, and Sodium Silicate are marketed to the cosmetic industry by SASSI members.

Additionally, CIR has received 2021 VCRP data and the Use Table (Table 4) have been updated (*silsal032021fda*). Uses have decreased for most ingredients. For example, although Magnesium Aluminum Silicate still has the most reported uses in cosmetic products, with a total of 383, the total uses in 2020 were reported previously to be 938. The majority of the current reported uses are in leave-on eye makeup preparations and skin care preparations. Also, Aluminum Calcium Sodium Silicate has the second most reported uses in cosmetic products, with a total of 103, and the majority of the uses are in lipsticks. Previously, the total uses in 2020 were reported to be 287. One ingredient, Magnesium Trisilicate, now has no reported uses; previously, it was reported to have 17. Increased uses were noted in 3 ingredients: Lithium Magnesium Sodium Silicate (increased from 57 to 97 uses, mostly in lipsticks), Magnesium Aluminometasilicate (increased from 5 to 22 uses, mostly in foundations), and Sodium Potassium Aluminum Silicate (increased from 19 uses to 31 uses, mostly in lipsticks).

The previously published silicate and silica reports are attached for your use:

- Final Report on the Safety Assessment of Aluminum Silicate, Calcium Silicate, Magnesium Aluminum Silicate, Magnesium Silicate, Magnesium Trisilicate, Sodium Magnesium Silicate, Zirconium Silicate, Attapulgite, Bentonite, Fuller's Earth, Hectorite, Kaolin, Lithium Magnesium Silicate, Lithium Magnesium Sodium Silicate, Montmorillonite, Pyrophyllite, and Zeolite (2003) [*silsal032021orig_2003*]
- Final Report on the Safety Assessment of Potassium Silicate, Sodium Metasilicate, and Sodium Silicate (2005) [*silsal032021orig_2005*]
- Amended Safety Assessment of Synthetically-Manufactured Amorphous Silica and Hydrated Silica as Used in Cosmetics (2019) [*silsal032021silica*]

Minutes from all past meetings at which any of the silicate ingredients named in this amended report were discussed, as well as minutes from discussions of the current report, are included with this submission:

- June 2018 through September 2020 – Minutes for the Panel’s deliberations since June 2018 when the re-review commenced [*silsal032021min1_reopened_rereview*]
- June 2009 and September 2009 - Silica and Related Cosmetic Ingredients [*silsal032021min2_silica*]
- December 1999, May 2000, December 2000 and June 2001 - Potassium Silicate, Sodium Metasilicate, and Sodium Silicate [*silsal032021min3_saltsilicates*]
- September 1999 and February 2000 - Aluminum Silicate, Calcium Silicate, Magnesium Aluminum Silicate, Magnesium Silicate, Magnesium Trisilicate, Sodium Magnesium Silicate, Zirconium Silicate, Attapulgit, Bentonite, Fuller’s Earth, Hectorite, Kaolin, Lithium Magnesium Silicate, Lithium Magnesium Sodium Silicate, Montmorillonite, Pyrophyllite, and Zeolite [*silsal032021min4_silicates*]

Other supporting documents for this report package include a flow chart (*silsal032021flow*), report history (*silsal032021hist*), a search strategy (*silsal032021strat*), and a data profile (*silsal032021prof*).

Based on the proceedings and comments from the September 2020 meeting, a draft Discussion has been included. The Panel should carefully consider and discuss the data (or lack thereof) and the draft Abstract and Discussion presented in this report, and issue a Tentative Report with a safe, safe with qualifications, insufficient data, unsafe, or split conclusion.

RE-REVIEW FLOW CHART

INGREDIENT/FAMILY Silicates

MEETING March 2021

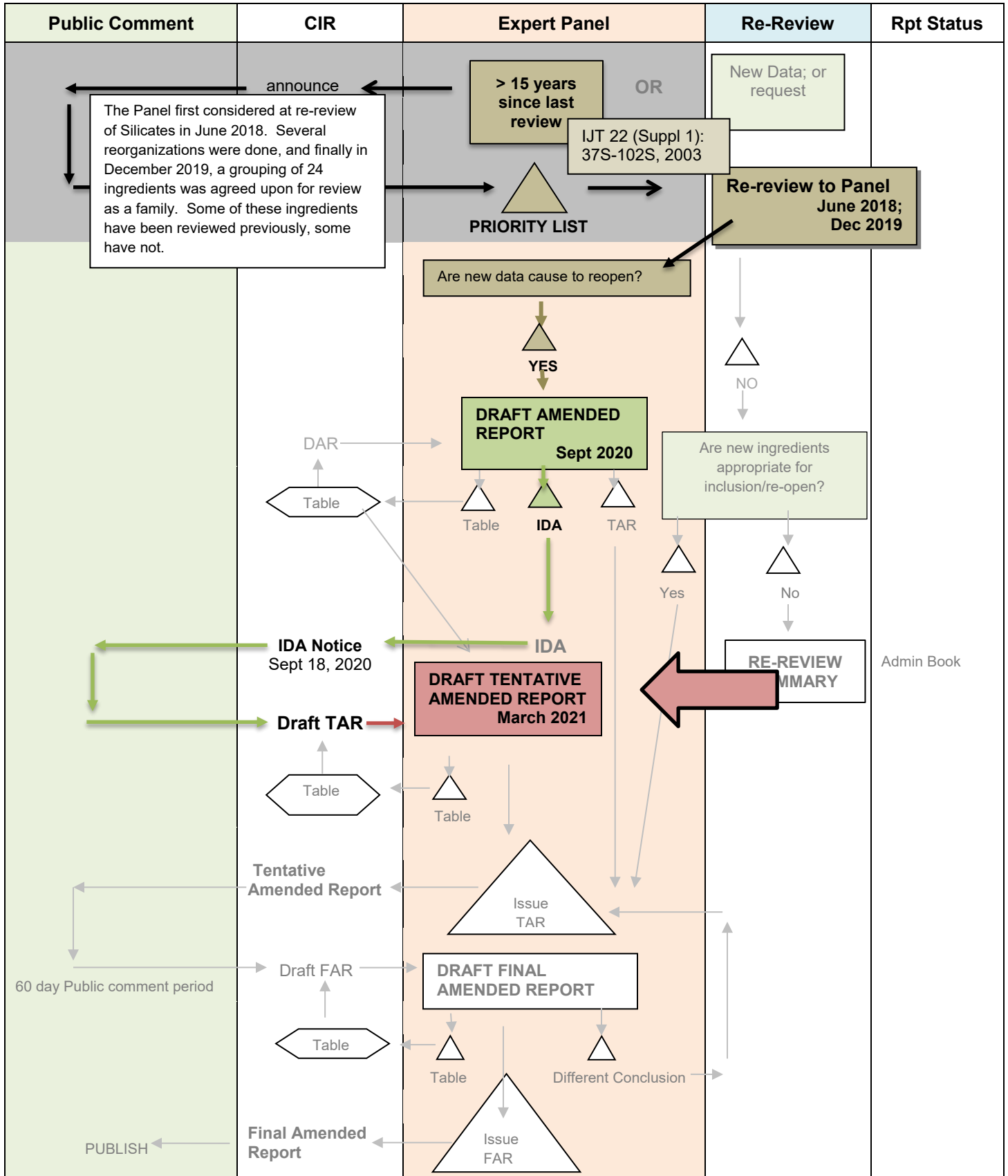

*If Draft Amended Report (DAR) is available, the Panel may choose to review; if not, CIR staff prepares DAR for Panel Review.

Silicates History

2003– The CIR’s Final Report on the Safety Assessment of Aluminum Silicate, Calcium Silicate, Magnesium Aluminum Silicate, Magnesium Silicate, Magnesium Trisilicate, Sodium Magnesium Silicate, Zirconium Silicate, Attapulgite, Bentonite, Fuller’s Earth, Hectorite, Kaolin, Lithium Magnesium Silicate, Lithium Magnesium Sodium Silicate, Montmorillonite, Pyrophyllite, and Zeolite in the *IJT* after the report was finalized by the Panel in 2000. Based on the available animal and clinical data available at that time, the Panel concluded that these ingredients are safe as cosmetic ingredients in the practices of use and concentrations as described in the safety assessment.

2005 – The CIR’s Final Report on the Safety Assessment of Potassium Silicate, Sodium Metasilicate, and Sodium Silicate in the *IJT* after the report was finalized by the Panel in 2001. Based on the available animal and clinical data available at that time, the Panel concluded that these ingredients are safe for use in cosmetic products in the practices of use and concentration described in the safety assessment when formulated to avoid irritation.

2009 – The CIR issued a Final Report on the Safety Assessment of Silica and Related Cosmetic Ingredients, which has not been published in the *IJT*. Based on the available animal and clinical data available at that time, the Panel concluded that Silica, Alumina Magnesium Metasilicate (now called Magnesium Aluminometasilicate), Aluminum Calcium Sodium Silicate, Aluminum Iron Silicates, Hydrated Silica, and Sodium Potassium Aluminum Silicate are safe as cosmetic ingredients in the practices of use and concentrations as described in the safety assessment.

April/May 2018 – Review of the available published literature since 2000 was conducted in accordance to CIR Procedure regarding re-review of ingredients after ~15 years.

June 2018 - The Panel decided to re-open the 2003 Silicates report and add an additional 23 ingredients, which include 9 silica and silicate ingredients that were previously reviewed by the Panel and 14 ingredients that have not been reviewed by the Panel.

The Panel noted that for many of the previously reviewed ingredients, uses have increased significantly.

December 2018 - The Panel issued an IDA for the 40 ingredients in the safety assessment. The additional data needed for the safety assessment of these cosmetic ingredients are:

- The range of particle sizes for all silica and silicate ingredients that are used in spray and powder formulations
- Chemical characterization, composition, and impurities data for all ingredients, except Silica
- Method of manufacturing and/or source data for all ingredients, except Silica and Hydrated Silica.

April 2019 - The Panel tabled discussion on 40 ingredients for administrative reorganization. CIR staff will reorganize these ingredients into 2 separate reports with the first report to be reviewed to include Silica, Hydrated Silica, and silicate ingredients, with a focus on ingredients that are synthetically derived. The second report will be comprised of the ingredients that are determined to be naturally sourced (i.e. mined), including clay materials, zeolites, and any other ingredients in the above list that are mined.

The data on all these ingredients are still considered insufficient to determine the conclusion on safety. The additional data needed for the two safety assessments of these cosmetic ingredients comprise:

- The mean and range of particle sizes for all silica and silicate ingredients (and corresponding sizes of final formulation particles) that are used in spray and powder formulations
- Chemical characterization, composition, and impurities data for all ingredients, except Silica
- Method of manufacturing and/or source data for all ingredients, except Silica and Hydrated Silica.

June 2019 - The Panel issued a tentative amended report with the conclusion that Silica and Hydrated Silica are safe in the present practices of use and concentration described in the safety assessment when formulated to be non-irritating. However, the Panel determined there were insufficient data to determine the safety of the remaining 22 ingredients.

The Panel emphasized that this report reviews the safety of synthetic amorphous Silica and synthetic amorphous silicate ingredients. Crystalline silica is not toxicologically similar to amorphous silica and would need to be reviewed separately.

The Panel reviewed the current safety test data on amorphous Silica and Hydrated Silica and determined that these two ingredients do not pose an inhalation safety risk. The exposures that were tested in inhalation studies were at much higher concentrations than those possible with cosmetic use, and had very few adverse effects. The carcinogenicity study used such high concentrations of Silica that the noted effects on the lymph nodes were due to the overload of the animal system: incidental inhalation of Silica in cosmetics is not a concern.

The data on the remaining ingredients were considered insufficient to determine the conclusion on safety. The additional data needed for the 22 silicate ingredients comprise:

- Chemical characterization (structure), composition, and impurities data for the silicate ingredients
- Method of manufacturing and/or source data for the silicate ingredients
 - Depending on the information provided, additional data on toxicological endpoints may be needed

September 2019 - The Panel issued a final amended report with the conclusion that synthetically-manufactured amorphous Silica and Hydrated Silica are safe in the present practices of use and concentration described in the safety assessment when formulated to be non-irritating.

The Panel emphasized that this report applies to the safety of synthetically-manufactured amorphous Silica and Hydrated Silica only. Crystalline silica is not toxicologically similar to synthetically-manufactured amorphous silica and would need to be reviewed separately, if used in cosmetics.

The Panel reviewed the current safety test data on synthetically-manufactured amorphous Silica and Hydrated Silica and determined that these two ingredients do not pose an inhalation risk. The concentrations that were tested in inhalation studies were at much higher concentrations than those found in cosmetics and yet had very few adverse effects. The carcinogenicity study used such high concentrations of Silica that the noted effects on the lymph nodes were due to the load on the animal system; incidental inhalation of Silica in cosmetics is not a concern.

Additionally, the Panel moved 22 silicate ingredients from this report to be reviewed at a later date with other silicate ingredients that are determined to be naturally sourced (i.e. mined), including clay materials, zeolites, and any other similar ingredients that are mined. Currently, the data on those ingredients are insufficient to support the determination of safety. The additional data needed for those ingredients comprise at least:

- Chemical characterization (structure), composition (including degree and % of crystallinity), and impurities data
- Method of manufacturing and/or source data
 - Depending on the information provided, additional data on toxicological endpoints may be needed

December 2019 - The Panel considered the proposed groupings of the 38 ingredients that had been previously removed from the Amended Safety Assessment on Silica and Hydrated Silica and a larger re-review package of silicate ingredients. The Panel accepted the groupings proposed by CIR Staff, which will be presented in 3 separate reports at future Panel meetings. The Panel also accepted the proposed addition of the ingredient, Clay, to the reviews. The groups are as follows:

Clays

Activated Clay
Attapulgite
Bentonite
Clay

Fuller's Earth
Hectorite
Kaolin
Montmorillonite

Silicates

Aluminum Silicate
Aluminum Calcium Sodium Silicate
Aluminum Iron Silicates
Aluminum Iron Calcium Magnesium Germanium Silicates
Aluminum Iron Calcium Magnesium Zirconium Silicates
Ammonium Silver Zinc Aluminum Silicate
Calcium Silicate

Calcium Magnesium Silicate
Lithium Magnesium Silicate
Lithium Magnesium Sodium Silicate
Magnesium Aluminometasilicate
Magnesium Aluminum Silicate
Magnesium Silicate
Magnesium Trisilicate

Potassium Silicate
Pyrophyllite
Sodium Magnesium Silicate
Sodium Metasilicate
Sodium Magnesium Aluminum Silicate
Sodium Potassium Aluminum Silicate

Sodium Silver Aluminum Silicate
Sodium Silicate
Tromethamine Magnesium Aluminum Silicate
Zinc Silicate
Zirconium Silicate

Zeolites

Ammonium Silver Zeolite
Gold Zeolite
Silver Copper Zeolite
Titanium Zeolite
Zeolite
Zinc Zeolite

September 2020 - The Panel issued an IDA for these ingredients. The additional data needed to determine safety were:

- Method of manufacturing, with specific focus to the origin of raw materials (synthetic versus mined derivation)
- Composition and impurities data, specifically percent quantification of any crystalline silica/silicate
- Inhalation toxicity data

Silicates Data Profile - March 2021, Christina Burnett

	Use		Method of Mfg	Composition/ Impurities	Toxicokinetic		Acute Tox			Repeated Dose Tox			DART		Genotox		Carcin		Dermal Irritation			Dermal Sensitization			Ocular Irritation		Clinical Studies	
	New Rpt	Old Rpt			Dermal Pen.	ADME	Dermal	Oral	Inhalation	Dermal	Oral	Inhalation	Dermal	Oral	In Vitro	In Vivo	Dermal	Oral	In Vitro	Animal	Human	In Vitro	Animal	Human	Phototoxicity	In Vitro	Animal	Retrospective/ Multicenter
Aluminum Silicate	X	O	O	O			X				O						X				X			X				
Aluminum Calcium Sodium Silicate	X	O		X			X																					
Aluminum Iron Silicates																												
Aluminum Iron Calcium Magnesium Germanium Silicates																												
Aluminum Iron Calcium Magnesium Zirconium Silicates																												
Ammonium Silver Zinc Aluminum Silicate	X																											
Calcium Silicate	X	O	X	X								O	O	O														
Calcium Magnesium Silicate																												
Lithium Magnesium Silicate	X																											
Lithium Magnesium Sodium Silicate	X																											
Magnesium Silicate	X		X	X																								
Magnesium Aluminum Silicate	X	O	X	XO			O	O				O	O							O	O					O		
Magnesium Aluminometasilicate	X	O																										
Magnesium Trisilicate	X						O					O																
Potassium Silicate	X	O	X				X	X	X											O	X				X		O	X
Pyrophyllite																												
Sodium Silicate	X	O	O	O			O				O	O								O	O				O			O
Sodium Magnesium Silicate	X	O	X	X																O						O		
Sodium Magnesium Aluminum Silicate				X				X																				
Sodium Metasilicate	X	O	O	O			X		O				O							O	O				X	O		O
Sodium Potassium Aluminum Silicate	X	O																										
Sodium Silver Aluminum Silicate			X	X																								
Zinc Silicate													X							X				X				
Zirconium Silicate								O																				

* "X" indicates that new data were available in this category for the ingredient; "O" indicates that data from the original assessment were available

Ingredient	CAS #	InfoB	SciFin	PubMed	TOXNET	FDA	EU	ECHA	IUCLID	SIDS	ECETOC	HPVIS	NICNAS	NTIS	NTP	WHO	FAO	NIOSH	FEMA	Web
Pyrophyllite	11349-10-3; 113349-11-4; 113349-12-5; 12269-78-2; 141040-73-5; 141040-74-6	√	√	√	√	√	√	√	√	√	√	√	√	√	√	√	√	√	√	√
Sodium Silicate	1344-09-8	√	√	√	√	√	√	√	√	√	√	√	√	√	√	√	√	√	√	√
Sodium Magnesium Silicate		√	√	√	√	√	√	√	√	√	√	√	√	√	√	√	√	√	√	√
Sodium Magnesium Aluminum Silicate	12040-43-6	√	√	√	√	√	√	√	√	√	√	√	√	√	√	√	√	√	√	√
Sodium Metasilicate	6834-92-0	√	√	√	√	√	√	√	√	√	√	√	√	√	√	√	√	√	√	√
Sodium Potassium Aluminum Silicate	12736-96-8; 66402-68-4	√	√	√	√	√	√	√	√	√	√	√	√	√	√	√	√	√	√	√
Sodium Silver Aluminum Silicate		√	√	√	√	√	√	√	√	√	√	√	√	√	√	√	√	√	√	√
Zinc Silicate	13597-65-4	√	√	√	√	√	√	√	√	√	√	√	√	√	√	√	√	√	√	√
Zirconium Silicate	10101-52-7; 1344-21-4	√	√	√	√	√	√	√	√	√	√	√	√	√	√	√	√	√	√	√

Typical Search Terms

- INCI names
- CAS numbers
- chemical/technical names
- additional terms will be used as appropriate

Total references ordered/downloaded from initial searches = 45 (some relevant hits were duplicates)

Search updated January 2021, no new relevant studies.

Search Strategy: Re-review ingredients limited time frame from 2000-2018, except where noted

PubMed

Aluminum Silicate – 11825 hits, limited with toxicity = 770 hits, limited with irritation = 14 hits (4 relevant), limited with sensitization = 9 (0 relevant), limited with dermal = 20 hits (5 relevant)
Aluminum Calcium Sodium Silicate – 6 hits (0 relevant)
Aluminum Iron Silicates - 281 hits, limited with toxicity = 27 hits, limited with irritation = 0 hits, limited with sensitization = 0 hits, limited with dermal = 0 hits
Aluminum Calcium Magnesium Potassium Sodium Zinc Silicates - 2 hits (0 relevant)
Aluminum Iron Calcium Magnesium Germanium Silicates – 0 hits
Aluminum Iron Calcium Magnesium Zirconium Silicates – 0 hits
Ammonium Silver Zinc Aluminum Silicate – 1 hit (0 relevant)
Calcium Silicate – 1181 hits, limited with toxicity = 79 hits, limited with irritation = 0 hits, limited with sensitization = 0 hits, limited with dermal = 1 hit (0 relevant)
Lithium Magnesium Silicate – 3 hits (0 relevant)
Lithium Magnesium Sodium Silicate – 2 hits (1 relevant)
Magnesium Aluminometasilicate – 24 hits (0 relevant)
Magnesium Aluminum Silicate – 80 hits (1 relevant)
Magnesium Silicate – 776 hits, limited with toxicity = 31 hits (3 relevant), limited with irritation (0 relevant), limited with sensitization = 1 hit (0 relevant), limited with dermal = 1 hit (0 relevant)
Magnesium Trisilicate – 198 hits (2 relevant)
Potassium Silicate – 912 hits, limited with toxicity = 25 hits (1 relevant), limited with irritation = 4 hits (0 relevant), limited with sensitization = 0 hits, limited with dermal = 0 hits
Pyrophyllite – 946 hits, limited with toxicity = 60 hits (0 relevant), limited with irritation = 3 hits (0 relevant), limited with sensitization = 0 hits, limited with dermal = 0 hits
Sodium Magnesium Silicate – 66 hits (1 relevant)
Sodium Magnesium Aluminum Silicate – 19 hits (0 relevant)
Sodium Metasilicate – 84 hits (5 relevant)
Sodium Potassium Aluminum Silicate – 8 hits (0 relevant)
Sodium Silicate – 338 hits (3 relevant)
Sodium Silver Aluminum Silicate - 18 hits (0 relevant)
Zinc Silicate - 70 hits (0 relevant)
Zirconium Silicate – 350 hits (0 relevant)

SciFinder: Re-review ingredients limited time from from 2000-2018, except where noted, and to Adverse Effects and English

Aluminum Silicate – 10 hits, 0 relevant (CAS#1335-30-4), 25 hits, 0 relevant (CAS#1327-36-2)
Aluminum Calcium Sodium Silicate (from 2005-2018) – 15 hits, 2 relevant
Aluminum Iron Silicates (from 2005-2018)
Aluminum Iron Calcium Magnesium Germanium Silicates – 0 hits
Aluminum Iron Calcium Magnesium Zirconium Silicates - 0 hits
Ammonium Silver Zinc Aluminum Silicate – 0 hits
Calcium Magnesium Silicate – 1 hit, 0 relevant
Calcium Silicate - 5 hits, 1 relevant (CAS# 10034-77-2), 60 hits, 4 relevant (CAS#1344-95-2)
Lithium Magnesium Silicate – 0 hits
Lithium Magnesium Sodium Silicate – 1 hit, 1 relevant
Magnesium Aluminometasilicate – 0 hits
Magnesium Aluminum Silicate – 4 hits, 1 relevant (CAS#1327-43-1), 0 hits (CAS#12511-31-8), 20 hits, 0 relevant (CAS#12199-37-0)
Magnesium Silicate – 11 hits, 1 relevant
Magnesium Trisilicate – 7 hits, 1 relevant
Potassium Silicate – 0 hits (CAS#10006-28-7), 5 hits, 0 relevant (CAS#1312-76-1)
Pyrophyllite – 0 hits (CAS#141040-74-6), 0 hits (CAS#141040-73-5), 0 hits (CAS#13349-12-5), 0 hits (CAS#113349-11-4), 0 hits (CAS#113349-10-3), 0 hits (CAS #12269-78-2)
Sodium Magnesium Silicate – 0 hits
Sodium Potassium Aluminum Silicate (from 2005-2018) – 0 hits
Sodium Metasilicate – 13 hits, 5 relevant
Sodium Silicate – 16 hits, 1 relevant
Sodium Silver Aluminum Silicate – 0 hits
Sodium Magnesium Aluminum Silicate – 0 hits
Zinc Silicate – 0 hits (CAS #127734-84-3), 0 hits (CAS#126755-25-7), 0 hits (CAS#13814-85-2), 1 hit, 0 relevant (CAS#13597-65-4) 0 hits (CAS#11126-29-7)

Zirconium Silicate – 5 hits, 0 relevant (CAS#10101-52-7), 5 hits, 0 relevant (CAS#1344-21-4)

LINKS

Search Engines

- Pubmed (- <http://www.ncbi.nlm.nih.gov/pubmed>)
- Toxnet (<https://toxnet.nlm.nih.gov/>); (includes Toxline; HSDB; ChemIDPlus; DART; IRIS; CCRIS; CPDB; GENE-TOX)
- Scifinder (<https://scifinder.cas.org/scifinder>)

appropriate qualifiers are used as necessary
search results are reviewed to identify relevant documents

Pertinent Websites

- wINCI - <http://webdictionary.personalcarecouncil.org>
- FDA databases <http://www.ecfr.gov/cgi-bin/ECFR?page=browse>
- FDA search databases: <http://www.fda.gov/ForIndustry/FDABasicsforIndustry/ucm234631.htm>;
- EAFUS: <http://www.accessdata.fda.gov/scripts/fcn/fcnavigation.cfm?rpt=cafuslisting&displayall=true>
- GRAS listing: <http://www.fda.gov/food/ingredientspackaginglabeling/gras/default.htm>
- SCOGS database: <http://www.fda.gov/food/ingredientspackaginglabeling/gras/scogs/ucm2006852.htm>
- Indirect Food Additives: <http://www.accessdata.fda.gov/scripts/fdcc/?set=IndirectAdditives>
- Drug Approvals and Database: <http://www.fda.gov/Drugs/InformationOnDrugs/default.htm>
- <http://www.fda.gov/downloads/AboutFDA/CentersOffices/CDER/UCM135688.pdf>
- FDA Orange Book: <https://www.fda.gov/Drugs/InformationOnDrugs/ucm129662.htm>
- OTC ingredient list:
<https://www.fda.gov/downloads/aboutfda/centersoffices/officeofmedicalproductsandtobacco/cder/ucm135688.pdf>
- (inactive ingredients approved for drugs: <http://www.accessdata.fda.gov/scripts/cder/iig/>)
- HPVIS (EPA High-Production Volume Info Systems) - <https://ofmext.epa.gov/hpvis/HPVISlogon>
- NIOSH (National Institute for Occupational Safety and Health) - <http://www.cdc.gov/niosh/>
- NTIS (National Technical Information Service) - <http://www.ntis.gov/>
- NTP (National Toxicology Program) - <http://ntp.niehs.nih.gov/>
- Office of Dietary Supplements <https://ods.od.nih.gov/>
- FEMA (Flavor & Extract Manufacturers Association) - http://www.femaflavor.org/search/apachesolr_search/
- EU CosIng database: <http://ec.europa.eu/growth/tools-databases/cosing/>
- ECHA (European Chemicals Agency – REACH dossiers) – <http://echa.europa.eu/information-on-chemicals;jsessionid=A978100B4E4CC39C78C93A851EB3E3C7.live1>
- ECETOC (European Centre for Ecotoxicology and Toxicology of Chemicals) - <http://www.ecetoc.org>
- European Medicines Agency (EMA) - <http://www.ema.europa.eu/ema/>
- IUCLID (International Uniform Chemical Information Database) - <https://iuclid6.echa.europa.eu/search>
- OECD SIDS (Organisation for Economic Co-operation and Development Screening Info Data Sets)-
<http://webnet.oecd.org/hpv/ui/Search.aspx>
- SCCS (Scientific Committee for Consumer Safety) opinions:
http://ec.europa.eu/health/scientific_committees/consumer_safety/opinions/index_en.htm
- NICNAS (Australian National Industrial Chemical Notification and Assessment Scheme)-
<https://www.nicnas.gov.au/>
- International Programme on Chemical Safety <http://www.inchem.org/>
- FAO (Food and Agriculture Organization of the United Nations) - <http://www.fao.org/food/food-safety-quality/scientific-advice/jecfa/jecfa-additives/en/>
- WHO (World Health Organization) technical reports - http://www.who.int/biologicals/technical_report_series/en/
- www.google.com - a general Google search should be performed for additional background information, to identify references that are available, and for other general information

JUNE 2018 PANEL MEETING – RE-REVIEW

Belsito's Team Meeting – June 4, 2019

DR. BELSITO: Silicates. This was also part of Wave 2. And this is a re-review with a question of add-ons, correct?

MS. BURNETT: Correct. And I handed out at the table this morning to help clarify what add-ons are where, hopefully to help your discussion.

DR. BELSITO: Yes, I didn't see that. I said combined them all, add in the new ones. We need to take a look regardless. Usage has increased astronomically for many, and we need a sense of concentration of use, regardless of what we decide to do. That was my analysis.

DR. LIEBLER: Yeah, I said reopen to add all the new ingredients. This is a chemically heterogeneous group, so the new ingredients easily belong. That's the benefit of the dog's breakfast, by the way.

However, their properties aren't significantly different, and existing data covers the entire group. No need for new data, we can affirm the previous conclusion.

DR. BELSITO: I don't know that we can confirm it until we get a sense of concentration of use.

DR. LIEBLER: Fine.

DR. EISENMANN: And the report is not correct. The concentration of use survey has not been started on silica and hydrated silica. Those weren't included in the list they gave me. And I don't expect that to be -- if I get it started -- those are high use ingredients, so it's going to take at least --

DR. BELSITO: That's fine.

DR. EISENMANN: So, don't expect to see this until December.

DR. BELSITO: Oh, I wanted to see it in September.

DR. EISENMANN: Well --

DR. BELSITO: I'm teasing you Carol.

DR. EISENMANN: -- I doubt we'll get to those that quick.

DR. BELSITO: No, I mean, that's fine. I just thought that we could open, merge them all, add in the new ones. But the use has increased astronomically, which is part of the reason to look at it again anyway.

DR. EISENMANN: I was a little concerned about -- see I think this isn't chemistry that drives the toxicity of these ingredients, it's more structure. And it wasn't really addressed at all in this report. There is a discussion that's in the silica report about amorphous versus crystalline. I don't know, that's part of my concern about combining this, that that might get lost.

DR. BELSITO: Okay, so, run that by me again. Your concern here is not the chemistry it's the structure.

DR. EISENMANN: It's the physical structure of these compounds.

DR. BELSITO: Dan, you need to address that because that's above my head.

Synthetic Amorphous Silica and Hydrated Silica – Expert Panel for Cosmetic Ingredient Safety Meeting Transcripts

DR. EISENMANN: Right, and I'm not an expert in it either. I just know that was a big issue in the report, and the report hasn't been published, so I'm a little concerned about --

MS. BURNETT: Because that report hasn't been published, pretty much the entirety -- it will be reorganized into current format. But the bulk of the data will still be there. It's not going to be like the published paper re-review, where we italicize it, and then it doesn't get published. This will go directly into this paper; and so, it will be like a, you know, silica 2.0 version for the panel to review.

DR. BELSITO: Right. How come that report wasn't published?

MS. FIUME: I don't know. It may have been internal. It may have been journal, I'm not sure. But it did need some reorganization. So, it'll be incorporated in here and all of the information will get published.

DR. BERGFELD: With the mention of the structural differences, is it possible to reorganize according to the structure?

DR. BELSITO: Anything is possible.

DR. LIEBLER: To the extent that they're all structurally characterized. I suppose. The structure issue, as opposed to the chemical substance issue, Don, is like these crystalline silica versus amorphous silica. Chemically, in a chemical composition sense, they're about the same. In the way that the structure is, they're very different. And because the structure is different, they interact with biological components differently.

MS. BURNETT: I'm still reading and trying to understand the original report. But as I have read the physical properties and method of manufacture section, we have clearly stated that the cosmetic silica is amorphous not crystalline.

So as far as I understand, the data that is in this report is only on the amorphous silica. And there are like different names within the amorphous silica, but we go by the INCI names. So, if the amorphous silica is the silica, that's what the report is on.

DR. LIEBLER: I use that as an example of a structure difference for Don to explain, I think, what Carol was pointing out. I don't know how these partition into crystalline or amorphous. If the data you have so far says these are all amorphous silicates, then that's what they are. And I guess we're going to need more data to make decisions about grouping them.

MS. BURNETT: Okay.

DR. LIEBLER: Are you going to think about subgrouping them? I don't know if we are. I don't know if we need to.

DR. KLAASSEN: Here we do have, in contrast to one of the chemicals we were talking about this morning, you know, It is well known -- and as you know -- that some silica compounds can cause silicosis, which is a real lung disease. And so, we need to make sure that we know which ones might cause silicosis and which ones don't cause silicosis.

DR. BELSITO: But isn't that the point Christina was making with the amorphous versus crystalline? Because it's the crystalline ones that cause silicosis.

DR. KLAASSEN: But that's what I'm saying; we need to make sure that all of these that we have here -- or what is known about it to make -- we need to make sure that these are all the amorphous. And how strong is the data, first of all, that it has to be an amorphous compared to a crystalline, et cetera; which I don't know offhand.

MS. FIUME: I do know, looking at the minutes, PDF Page 54, maybe that's the 2009 review; where the Panel determined that silicosis is not an issue since crystalline silica is not an ingredient used in cosmetics. So, that's what was discussed at that time, that it's not crystalline.

DR. BELSITO: So, as you go through the add-ons, et cetera, just make sure that what we're talking about is amorphous. Anything else?

Marks' Team Meeting – June 4, 2018

DR. MARKS: I know. Silicates. Let's see, I have silicates are the next.

DR. SHANK: That's what I have.

DR. MARKS: And this is silicate related ingredients re-review.

MS. BURNETT: This morning, to help in the discussion -- I apologize, when I wrote this report, I didn't put in a table summarizing which ingredients were the existing ingredients, which were the previously reviewed ingredients, and which were the brand new potential add-ons.

It was clear to me because I had my table, but I didn't include it in the report. I handed that out this morning to help you see which was which; so that when you're talking you know which ingredients --

DR. SHANK: Thank you. Thank you.

DR. ANSELL: Do you have an extra copy of that by any chance?

MS. BURNETT: I don't have any extra copies.

DR. SHANK: Here, I'll give you mine.

DR. ANSELL: Can you part with it?

DR. SHANK: Sure. Who needs it?

MS. BURNETT: Oh, she has electronic.

DR. SHANK: You want it?

MS. BURNETT: No. I'm good, I have mine. I have it on my computer, so I can view it.

DR. SHANK: Okay.

DR. MARKS: Thank you, Christina. I know when I went through this I was going back to the original reports, which the last one I have is on page 226 of the PDF, which was the conclusion on the silicate aluminum magnesium, et cetera. Okay.

As Christina documents in her memo on May 23rd, this is a re-review. And basically, we have a conglomeration of stuff. There are ingredients -- there is the suggestion to consolidate ingredients from three reports previously. And they are on page 89, 155 and 226, for those who want to refer to that. And then 16 add-ons.

And then, in terms of the reports themselves, in 2003, there are 17 silicates that were safe. Then in the next paragraph, Christina talks about the 16 possible add-ons. And then, let me see, in the 2005 and 2009 reports with -- I have to look at the conclusions. Did I put -- are they all safe? Or one them was irritation, wasn't there?

MS. BURNETT: 2005 the potassium sodium, metasilicate and sodium silicate have a formulated to be nonirritating.

DR. MARKS: Nonirritating, yes.

MS. BURNETT: They were part of the original group, that were reviewed, and the panel decided to split them off. Then during the discussion in 2009, for the silica report, it was mentioned that when these were re-reviewed, that they would all be grouped together. I don't know if you saw that; but I had a good laugh when I read that. Saying, we will let the folks in 2018 deal with it. Well, guess what? You guys are all still here.

DR. HILL: Here we are. I saw that. I chuckled.

MS. BURNETT: And you have to deal with it.

DR. HILL: It's 2018 already.

MS. BURNETT: And just to remind the panel, the final report of the 2009 silica report was never published.

DR. MARKS: Yes. Thank you.

MS. BURNETT: It's kind of hanging in limbo right now.

DR. MARKS: Yeah. Okay. Yeah, the irritation and sensitization were okay, except the silicates were irritating. That's page 83.

I think the first question, is do we want to open this? Obviously this 2003 report. And that can either be for changing the conclusion, or it can be for add-ons and consolidation. Do we want to reopen or not?

DR. SHANK: I don't think it's useful to reopen.

DR. SLAGA: I've been with reopening this; I like combining all of these together.

DR. MARKS: Hmm, interesting.

DR. SLAGA: I don't remember who pushed to have it separated a long time ago. I know the panel did, but I --

MS. BURNETT: I don't remember.

DR. SLAGA: The other group, way over there?

MS. BURNETT: The team minutes were not really published back then, so I can't really tell.

DR. MARKS: Oh, is that right?

MS. BURNETT: It's summarized.

DR. HILL: They're summary versions.

MS. BURNETT: Yeah. They're summary versions.

DR. SHANK: I don't see how it's useful, what that accomplishes. And I think you may have trouble publishing that if most of the report is already -- if you put it all together, you're going to have to justify it, to some journal, that it's already been published, now we're putting it together. I don't see -- it's not worth the effort.

DR. SLAGA: Well, what about the 16 though? The 16 possible.

DR. MARKS: Yeah. That's the question I would add, is the new 16 add-on ingredients that have never been reviewed before.

DR. SHANK: Okay. There's very little data on those 16, and only two of them are used. So that could be handled in the re-review summary without reopening. I certainly would not combine --

DR. SLAGA: Published data.

DR. SHANK: -- all of these into one report.

DR. ANSELL: That's really our comment for recommending not reopening; is that we would like to hear a much more substantive discussion as to why these three reports form a relevant family.

DR. HILL: Here's what I wrote. I think in general, maybe we should bring everything together and get a global view of properties; and then respectively separate into either different reports, or at least different subsections very carefully constructed so any read across that is or isn't used is very clear.

Sodium metasilicate is very different from synthetic amorphous silica or zeolite. And I'm also not prepared to read across from sodium silicate to something like sodium aluminum silver silicate, or silver copper zeolite, where there are different metals with different redox properties, blah, blah, blah, blah, blah. Anyway, so I guess I'm at a level agreeing with Dr. Shank.

DR. SLAGA: But how do we deal -- there's two of them that are being used.

DR. HILL: Which two are they?

DR. SLANK: Zinc zeolite and --

DR. SLAGA: Would that be worthwhile to add those two? I mean, being consistent with earlier, where we didn't want to add them because they were not in use. But two of them are in use out the 16.

MS. BURNETT: Ammonium silver and zinc.

DR. HILL: Ammonium silver --

DR. SLAGA: I know doesn't seem much to add but --

MS. BURNETT: Ammonium silver zinc.

DR. SLAGA: -- some consistency here.

DR. ANSELL: Well, then we would just open up that report. We don't have to open all three of them to merge them. If we feel that --

DR. SLAGA: No, no. Eliminate the others that have been published already. I'm talking 2 out of 16.

DR. HILL: Well then actually, the six that haven't been published from 2009.

MS. FIUME: Right. So, it would be 22 that have not been published yet.

DR. SLAGA: Oh, okay.

DR. HILL: And are they across all three families?

MS. FIUME: The 2009 ingredients, that report has not been published. So, it wouldn't be republishing existing information.

DR. SLAGA: Which one?

MS. FIUME: The 2009 report. The silica and silicate ingredients. I mean, if there's commonality to create a family out of all of these -- or any of these; because we do need to consider, number one, the re-review. But once you reopen the re-review, you don't have to read across. You can make a split conclusion if the family fits together, but you don't have enough information to decide on all of them.

You can do a split conclusion. It doesn't have to be read across. Once you decide to reopen, you know, if you're combining -- because there are different conclusions among the ingredients you would be combining. Then you can start a whole new review.

DR. ANSELL: I think we would have an issue with reopening to add an ingredient, and then determine that the existing data is insufficient to support that new ingredient.

DR. SHANK: That's not a no-brainer then.

DR. ANSELL: Yeah. It would need its own report, which you guys could always do.

DR. SHANK: Why were the six ingredients in 2009 never published?

MS. FIUME: I believe the journal may have liked to see some additional information, or it may have needed a little bit of --

MS. BURNETT: Reorganization.

MS. FIUME: -- reorganization for publication.

DR. SHANK: So, it was sent to a journal and the peer review said change it?

MS. FIUME: I'm not sure if it's an internal decision or if it was a journal decision. I'm not sure, at that point, if it was done or not.

DR. SHANK: Okay.

MS. BURNETT: It's been almost ten years, so.

MS. FIUME: Yeah.

DR. ANSELL: Yeah. And I think that's our core point. I mean, safety is one thing. We just don't understand why we would reopen for purposes of merging these without --

MS. FIUME: Well, we have done it in the past, where we've reopened and based on the ingredients themselves, the conclusion it may not have been worthwhile to go forward. But we have created bigger families and looked at it as a full report, not simply -- once the decision was made to reopen because some of them were no brainers, those were brought in, because we were initiating a full report.

So, we've done it both ways in the past. But again, it's the panel's purview as to how they'd like to go forward, with this group, based on the similarity -- the information that's already included.

DR. HILL: For me, the 2003 grouping is a strange looking family. I mean, I would have put the clays together and that's it. You know, and then some of these other silicates together and that's it.

And then some of the new ones and some of these ones in the other report fit with that, but not that. You know, so that's when I say -- I mean, you published in 2003, you reached conclusions, but it's a strange grouping.

DR. MARKS: We're still at the point -- initially, we said we did not want to reopen. We don't want to consolidate the ingredients from the previous reports -- the previous three reports. Two out of the three reports were published.

And then we didn't like all the add-ons, but two of them are being used. Do we reopen to address the two add-ons that are being used?

And then obviously, the comments you made, Ron Hill, about the lack of consistency of the grouping of the ingredients raises some issue. Although that 2003, all them were safe. Even though maybe the grouping isn't to your liking.

So, where should we go team? Do you want to not reopen, or do you want to -- and which of the two of the new add-ons are being used?

DR. ANSELL: Ammonium silver zinc --

DR. HILL: Aluminum silicate. It's the fifth one down in her table. And zinc zeolites, all the way at the --

DR. MARKS: Zinc zeolite. That's one use. And then what was the other? The ammonium silver zinc aluminum silicate, is that the one?

DR. HILL: Yes.

DR. MARKS: And how many ingredients is that? Or how many products?

DR. ANSELL: Seventeen.

MS. BURNETT: It's in 17 and has a use concentration.

DR. MARKS: Yeah, 17 is a lot.

DR. HILL: So, one way to fly on this, or at least for discussion to think about, is pull ingredients out of that 2009 group that never got published, that go with this one or that one. I don't see any zeolites, but there are silicates that would fit.

So, you pull the silicates that go with the ammonium silver zinc aluminum silicate and see what data you got. And then we had that sassy publication in the interim. I think that was actually my second meeting here in 2009, if I'm not mistaken.

And we have the whole transcript covered, which I captured, which I read. And I thought that was -- it reminded me of things I heard -- it's hard to say, nine years ago, but nine years ago.

DR. MARKS: So, what you're suggesting is -- and that would be reopening, but not reopening the '03 report, reopening the '09 report. Because it is a report even though it wasn't published.

DR. HILL: Well, it never was published.

DR. MARKS: Well, that doesn't matter. From a CIR point of view, it's a report.

DR. SHANK: Right.

DR. MARKS: Am I not correct?

DR. SHANK: Yes.

DR. HILL: I got you. Okay, well -- okay then maybe --

DR. SLAGA: But that could be decided some other time.

DR. MARKS: We could talk about that today and perhaps -- so we don't want to reopen the 2003 report? We're pretty solid about that.

And then should we mention, tomorrow, to consider -- because it'll be very interesting to see, obviously, what the Belsito team, their approach. Our approach would be to reopen the 2009 report and add, where appropriate, the new add-ons which is --

DR. HILL: It's really the one that has 17 uses, I think, I heard.

DR. MARKS: Seventeen uses. The zeolite is chemically significant, different from the silicate ingredients in the 2009; you would include that, since that has one use?

DR. HILL: Yeah. I mean, if you're going -- a re-review summary is going to be written for the 2003; so, if you don't want to reopen, I guess then that zinc zeolite stays in orphan. Is there any downside to having it stay in orphan other than just one we have in the dictionary that's not been reviewed?

DR. MARKS: Right. And the other is if we suggest the 2009 report, 15 years, that's 2000 -- let me see, 2024 right? We put it off for another eight years or so.

DR. SHANK: Beyond my time.

DR. MARKS: So, second, not reopen the 2003 report. We're solid on that one, team? And then we could consider reopening the -- our suggestion would be if there is -- it doesn't sound like there's any urgency to these new add-ons. I mean, is the aluminum silver -- there are no alerts or concerns about these two that are in use.

MS. FIUME: Not that I'm aware of. But I can I just -- for a procedural question. I know there's been a lot of discussion this morning about whether they're in use or not in use. As part of the reopen decision, which is a new turn as I'm sure Dr. Bergfeld will point out tomorrow. But a lot of these silicates that are just a combination of aluminum, or calcium, or magnesium, which were in the 2003 report, you don't feel they can be no-brainers; and added to that report and be reopened for add-ons as no-brainers?

DR. SLAGA: I mean, that's what I originally thought.

MS. FIUME: That would be our typical --

DR. ANSELL: Ammonium, silver, zinc and zinc zeolite add to the '03.

MS. FIUME: But there is aluminum calcium magnesium potassium sodium zinc silicate. And you know, we've done aluminum silicate. And, you know, we've done aluminum silicate, we've done calcium silicate, we've done magnesium silicate. So, there is a calcium magnesium silicate as a proposed add-on.

If you don't want the entire list of 16 -- regardless of in use or not in use -- are there some that can be brought in as no-brainers, and brought into the 2003 report? And would you consider, at least, taking that step?

Synthetic Amorphous Silica and Hydrated Silica – Expert Panel for Cosmetic Ingredient Safety Meeting Transcripts

DR. HILL: For me, as soon as you have silver in there then that's not necessarily, chemically a no-brainer without some additional information. Because there's nothing with silver in it, on it, or around it, in the original 2003.

DR. MARKS: Okay.

DR. HILL: And that has redox properties that aren't present in these other metals from the 2003 one.

MS. FIUME: But there is a calcium magnesium silicate.

DR. SLAGA: Right.

DR. HILL: Silver is nothing --

MS. FIUME: There's a sodium magnesium aluminum silicate, as ingredients that have not yet been reviewed.

MS. BURNETT: So, possibly eliminate the silver ones.

MS. FIUME: So, could they be brought in reopened to add these no-brainers?

DR. MARKS: And then we can list the specific ones. But I see what you're saying, that of the potential add-ons, limit that 16 to ones which are chemically very similar to the 2003 report no-brainers, and reopen and add those. Don't consolidate.

Tom, you seem to be indicating that sounds okay. Ron Shank, do you have a problem with that? And we can list which ones. We mentioned the calcium magnesium silicate, and there are several others -- or a couple others. What is your sense, Ron Shank?

DR. SHANK: You're taking the no-brainers from the new add-ons?

DR. MARKS: Yes.

DR. SHANK: And adding them to the 2003?

DR. MARKS: So, like calcium magnesium silicate would be one of the no-brainers. Not silver, based on Ron Hill's concern.

DR. SHANK: Okay. So, out of those 16, the only --

DR. MARKS: Yes. So, let's go there.

DR. SHANK: -- one that is used is zinc zeolite.

DR. HILL: And ammonium silver --

DR. SHANK: Or the silver. And Dr. Hill says count in -- that's not a no-brainer. So, you're reopening to add zinc zeolite, which has one use.

DR. SLAGA: No, no. Add even the ones that are not being used --

DR. MARKS: Calcium magnesium silicate.

DR. SLAGA: -- to this because they've never been reviewed.

MS. FIUME: I mean, they're in the dictionary.

DR. SLAGA: We eliminated -- re-reviewed based on it wasn't a no-brainer. That was the final earlier today. These are --

DR. ANSELL: So, you dropped silver. You'd keep germanium?

DR. HILL: There's still quite a few that you could keep though.

DR. SHANK: What about iron?

DR. HILL: Yeah. I think so.

DR. MARKS: So, let's go from the top. Obviously not activated clay. How about the second one, the aluminum calcium magnesium potassium sodium zinc silicate?

DR. HILL: So why not activated clay, because you've already got -- in the 2003 -- you've got attapulgite, bentonite, Fullers Earth, hectorite and kaolin.

DR. MARKS: So, you would add that?

DR. HILL: I think activated clay would be fine.

DR. MARKS: Okay.

DR. HILL: The next one would be fine. The next one would be fine. The next one would be fine. The next one would be fine. Then we've got two silvers, but I think the calcium magnesium silicate would be fine.

DR. ANSELL: Calcium magnesium germanium would be okay?

DR. HILL: Where's that?

DR. MARKS: Well, no.

DR. ANSELL: That's number three.

MS. BURNETT: The third one down.

DR. HILL: I don't know about germanium. That's iffy. I'd have to think about that. I'm sorry I didn't yet. Remember, my take was put them all together and then split them back out. But, I'm in a different mode now. I think germanium would be okay.

DR. MARKS: Okay. So, you don't like the silvers. Now we're down to the gold zeolite. Zeolite was safe in the '03 report. Adding gold to it, does that change it? And then we're into silver copper zeolite.

DR. HILL: So, I'd have to see what the definition of the gold one -- it really isn't very clear if I remember right.

MS. BURNETT: Yeah.

DR. HILL: What form the gold is in.

MS. BURNETT: Gold zeolite is a product obtained by the reaction of gold chloride with zeolite.

DR. MARKS: Yeah. So, it's gold plus zeolite.

DR. HILL: I have to think about that one and the germanium. But anyway, skipping that for the moment and the two silvers, then you still -- you have sodium magnesium, aluminum, here's another silver. I think titanium's okay. Tromethamine is new. So I flagged that at least.

But then the last of them is probably fine, based on what's in that grouping in 2003. I know it seems like I'm cherry picking, but I'm just looking at chemistry that I know.

DR. MARKS: So, you would have two, four, six, eight, nine ingredients if I count --

DR. HILL: Six, seven, eight, nine, maybe ten if we do zinc silicate. Did you catch that one?

DR. MARKS: Yup.

DR. HILL: Let's see, 1, 2, 3, 4, 5, 6, 7, 8, 9, 10 I count.

MS. BURNETT: I have nine.

DR. MARKS: Oh, I didn't include the gold since you were hesitating.

DR. HILL: No, I didn't. but I did include the last four -- all of the last four.

DR. MARKS: Okay. The last four.

DR. HILL: But that's just --

MS. BURNETT: Eliminating all the ones with silver.

DR. HILL: And I'm not sure about gold; I have to think about that.

DR. MARKS: And you've eliminated the zinc, the one that has 17 uses, the ammonium silver zinc aluminum silicate. So, we're adding on virtually everything with no use; although that hasn't been a -- these are no-brainers.

DR. HILL: And now the interesting question is, would you group all the ones that had silver and possibly with the gold in there, and then make another group and another report. But the only ingredient that's in use -- and I don't know about data --

MS. BURNETT: None of those are in use.

DR. HILL: -- would be the ammonium silver zinc aluminum silicate. What do we have in the way of data?

DR. MARKS: So, now we're at reopen the 2000 report and add approximately -- I'll say approximately -- somewhere around ten ingredients, which are no-brainers from that new add-on list. What's your sense, Ron Hill? You don't have a problem with that?

DR. HILL: I don't have a problem with that; or I don't have a problem with do not reopen, since most of those are not in use.

DR. MARKS: Ron Shank, which way do you lean? Still not reopen.

DR. SHANK: Yes. Not reopen.

DR. SLAGA: Reopen.

DR. MARKS: So, we have a split here. I mean the question is, is it really worth it for a bunch of ingredients that have no uses. But that shouldn't be --

DR. SLAGA: Well, zinc zeolite a product, right?

DR. MARKS: Yeah. One use for that one.

MS. BURNETT: I have data on that one.

DR. MARKS: But again, that's the criteria. Do we use that criteria for reopening? Some things I don't think we have. It's just as a no brainer.

MS. FIUME: I would like to state CIR has been trying to create, through the past couple of years, complete families, even if ingredients had been reviewed in the past.

DR. MARKS: Right.

MS. FIUME: Regardless of the number of uses. Because then I was going to channel Bart, a little bit, and say thank you for potentially adding the add-ons to the report. But then can we look at the 2005 and 2009 reports, because again, there are similar ingredients. So that our family is complete, in one place, could you consider bringing those into the report as well.

And they do have conclusion, but again, there is sodium potassium aluminum silicate in the 2009 report. So, it's sort of out there.

I guess one of our goals has been recently, as we prepare these bigger families, is that it makes sense to have a family of ingredients in one place. And that's, you know, what we've been striving to do. So, is it possible to make, even albeit large, a family of ingredients out of these combined four categories, if it was going to be redundant.

DR. ANSELL: Right.

DR. MARKS: And that's -- Ron Shank, right from the beginning, you didn't like the idea of combining all into one report?

DR. SHANK: I didn't see the need. Had that been done at the beginning, okay. But to go back and put them all together, half of them have already been published. So, now what you're saying is taking the 16 add-ons, and the 2009, and putting them all into a reopened 2003.

DR. MARKS: No. Actually --

DR. SHANK: And leaving the three irritating ones --

DR. MARKS: No. I wasn't that far along, Ron Shank.

DR. SLAGA: Ten out of 16 for the --

DR. MARKS: I was leaving 2009 standalone. And what I thought we were at was just taking the no-brainers and adding it to the 2003, which was proposed.

DR. SLAGA: That's all we're doing.

DR. SHANK: But there are no-brainers in 2009.

MS. FIUME: My request --

DR. MARKS: Well, that's already been --

DR. SLAGA: And that's what creating a family is.

MS. FIUME: Yes. If you were going to go ahead and reopen it, then could we look at the 2009, 2005, and say yes there are actually a lot of ingredients that also belong in that family, so that they're all in one place; if it were to be reopened.

DR. SLAGA: No-brainers.

DR. ANSELL: Right. But I think you're turning it kind of upside down. The reopening justification now is to order the family. And I think that was our original question, is that worth the effort?

MS. FIUME: Well, I guess, step one would be, are there no brainers that are now listed that have not been reviewed; and is that a reason to reopen to add. And if that is, we take that step. Then can we take the next step of looking at ingredients that, yes, were reviewed, because we've done this many times, and bring them into the family as well.

So, I'm looking at it as a step process; but if you go ahead and take the first step, is there any reason not to take the second step and create a whole family.

DR. SLAGA: Maybe that's a way to bring it up, the way it was stated. That the 2003 additions, no-brainers, and then approve that, and then say there's a possibility that the others could be brought in for a family relationship.

MS. BURNETT: I would like to point out that some of the potential add-ons that have the iron included, the iron was reviewed in 2009. You wouldn't have that data from the 2003 report, if that would aide anything.

DR. HILL: What you're saying is we're not sure if iron is a no-brainer read across. And I'm sort of asserting in these kinds of materials, it pretty well should be.

MS. BURNETT: Okay.

DR. MARKS: Well, our team should at least -- there's two different issues. We're still at -- and we have a split decision among the panel as to whether we not reopen versus open 2003 report and add the ten "no brainers". I say 10, it might be 9 or 11.

DR. HILL: It's around there, somewhere in there.

DR. MARKS: Versus the idea of reopening and consolidate. I hear you, Monice. Right from the get-go we said we didn't like to consolidate. But we also hear the idea, well this is in the same family, it'd be nice to have it all on one report.

Consolidate? Because we're back to that again. And we shouldn't -- I don't think we should go into tomorrow wavering that way, if we all feel don't consolidate. And we maybe have a split concern that way. It'll be interesting to see -- the good thing for me is I'm seconding the motion.

DR. SLAGA: That's right. If they say consolidate all of them, we'd say we agree.

MS. FIUME: And as a reminder, we've done it in the past where we have reopened, and then the next time you can come back and then look at it again as an entire family, with more information and change it.

Synthetic Amorphous Silica and Hydrated Silica – Expert Panel for Cosmetic Ingredient Safety Meeting Transcripts

But I just wanted to lay out all the steps. And I understand if it's not reopened, you know, that's the panel's prerogative. But I just wanted to lay out the steps of how to look at the thought process.

DR. HILL: And what you just said last was what I was proposing, even if it wasn't obvious by how I said it; is put the information together and then decide. But it's staff effort and I really appreciate that.

MS. BURNETT: Already started, so it's fine.

DR. HILL: Well, I mean, the problem is if they put you on something else --

DR. SLAGA: Alright Jim, you heard that. You could either punch them tomorrow or double punch them.

DR. MARKS: No. I think it would be since we're split on it, as long as they're not split, we're going to probably agree to whichever way they want to go.

DR. SLAGA: They're probably playing in their sandbox, right?

DR. MARKS: I see the advantage -- and I have in here consider consolidating with the 2005/2009 report. But my feeling is if their team -- from what you said Christina you've already started that, that consolidating them is not going to be a huge issue from your point of view. Staffing point of view.

MS. BURNETT: No.

DR. SHANK: Am I the outlier? This is a housekeeping issue as far as I'm concerned.

DR. MARKS: Yeah, exactly.

DR. SHANK: Not a science issue.

DR. MARKS: Yeah.

DR. SHANK: So, if you want to put them together, the staff won't throw rocks at us --

MS. BURNETT: I would have thrown those rocks a long time ago at somebody else, so it's good.

MS. FIUME: She would have thrown the rocks at Bart and I.

DR. HILL: I think in putting them together and looking at subgroupings in terms of what can be read across as -- I don't know that there's such a thing as a real no brainer but anyway -- that fit that criteria to a reasonable degree. And looking at sub -- I think some things will emerge that if we don't put them together, okay the sleeping dog will lie and there's probably no disaster to that too.

DR. MARKS: I'm going to second what I think's going to be the proposal to open the 2003 report. Put the add-ons; ten of them are we think no brainers. I'll ask you to talk about zinc tomorrow so just so, Ron Hill, you indicate --

DR. HILL: The silver?

DR. MARKS: Oh, silver. I'm sorry. Sorry, got the wrong metal. Silver, Ron Hill.

DR. HILL: I didn't bring my advance inorganic chemistry book with me to look at germanium and gold.

Synthetic Amorphous Silica and Hydrated Silica – Expert Panel for Cosmetic Ingredient Safety Meeting Transcripts

DR. MARKS: And then consolidate with the 2005 and 2009 reports and we'll see where it goes. I want to get to science now that we're past the procedural issues. Irritation and sensitization should be fine. It formulates to be nonirritating. That takes care of the silicates.

As I read it, there was some issues with respiratory in this. Is that true or not? And if it is, at least going forward, I wanted to get a preview of the science of the respiratory issues and how that's going to be address with these.

DR. SHANK: And where are you in all this 272 pages?

DR. MARKS: I put respiratory okay, use table 75. I guess there must have been a few things in here. I'm sorry, Ron, I just highlighted respiratory and I didn't put a page. I'm not sure where when I look through the report. Ron Hill?

DR. SLAGA: I didn't see anything.

DR. SHANK: We have four reports all in one.

DR. MARKS: Yeah, exactly. Let me see if I --

DR. HILL: I was looking at transcripts a lot and starting into this, since I wasn't around at the beginning.

DR. MARKS: Sorry, Ron. Maybe just put as an alert and as we go -- when it gets all consolidated. It seems to me it came out -- nothing stood out to you respiratory wise, Ron Hill?

DR. SHANK: Correct.

DR. MARKS: I mean, Ron Shank. Good.

MS. BURNETT: The summarized discussion from the original report mentioned --

DR. MARKS: Here it is. Page 89.

DR. SHANK: Page 89?

DR. MARKS: Page 89. This was the 2003 report. And if you look at the end of -- it says, "Panel considered that any spray containing these solids should be formulated to minimize their inhalation. With this admonition to the cosmetic industry, the CIR panel conclude that these ingredients are safe." So that must have been -- not in a conclusion, but in the discussion.

And then when you look at page 149, right above -- yeah. The conclusion doesn't mention any admonition to the cosmetic industry, which is kind of interesting. I thought that's pretty strong wording to not have in the conclusion.

And then, if you look right above the conclusion on page 149, not the note, but right before the note. The concentration of ingredients is very low. That's the respirable concentration. Even so, the panel considered that any spray containing these solids should be formulated to minimize their inhalation.

That could have been a conclusion. We do formulate to be nonirritating. Can you formulate to minimize inhalation? Or is that the way it's delivered?

DR. SLAGA: That might be coming up soon.

DR. MARKS: That's where I'm sure I got the inhalation concern.

Synthetic Amorphous Silica and Hydrated Silica – Expert Panel for Cosmetic Ingredient Safety Meeting Transcripts

DR. HILL: Yeah. I was reading back in the transcripts, and the discussion of talc came up which continues to remain an almost ridiculously contentious issue. But it's out there, heavily, in the consumer world, in discussion. Discussion, I use one word.

Because it mentions talc is a hydrated, magnesium silicate. And it gives the chemical composition. This is in the 149, right above the conclusion. Occurs in various forms and has unique crystalline structure. And talc is not included in this report. The significance there goes to the no-brainer contention with these add-ons.

DR. MARKS: Okay. I just wanted to, Ron, bring that up, and Ron and Tom, about I suspect at some point we're going to -- I have to address that again with it being reopened.

DR. SHANK: The respiratory issue?

DR. MARKS: Yeah. Or whether the inhalation boilerplate addresses it.

DR. SHANK: I think it does.

DR. MARKS: Yeah, okay. I think that's fine. Okay, well, we'll see what happens tomorrow. I'm planning on seconding it -- whether it's the motion or not -- opening the 2003 report with ten no-brainer add-ons. Silver, Ron Hill, has concerns. And depending on what, I'll ask you, Ron Hill, to -- and then we'll consolidate with the 2005 and 2009 reports. Does that sound okay now to everybody?

DR. SHANK: Yes.

DR. MARKS: Good. Okay. And we've taken care of the respiratory. Okay. Thank you. Christina and Monice, that was a -- I don't know, every ingredient we've had there has been some good discussion so far. Are we going to have one where it's, yes, that's fine. Let's move on to the next one.

Full Panel Meeting – June 5, 2018

DR. BELSITO: This is a re-review coming up from 2003, and there are 16 possible add-ons that have not been assessed by the panel. There were also silicates that have been reviewed and were published in 2005, mainly potassium silicate, sodium metasilicate, and sodium silicate.

And these would be additional materials that could be incorporated, so bringing that total of 19 into this report. But then there was also in 2009, assessment of silica and related cosmetics, and that safety assessment, it turns out, was never published for some reason, and would be due in another six years.

We felt that we could reopen this report; and also in addition to what was reviewed in 2003, include the 16 possible add-ons that haven't been looked at. And include the ones from 2005, the three there, as well as the ones in 2009, that were not published. So, essentially add all of the prior reports on the silicates together, add the new ones.

We need to take a look at this because usage has increased significantly for many of these. And we need a sense of the concentration of use before we decided on the safety. So, we would like to reopen, combine all of them, and at this point our real interest is what concentration they're used at. We may not need additional data based on that.

DR. BERGFELD: So, you're asking just to reopen and add?

DR. BELSITO: Reopen, add the 16, and combine the prior reports on silicates.

DR. BERGFELD: Okay. Dr. Marks?

DR. MARKS: We second that motion. I just want to clarify. So, you don't want to move forward with either a tentative report or an insufficient data announcement with the reopening.

DR. HELDRETH: Reopening would be a tentative report.

DR. MARKS: Okay then, if it's a tentative report we have to have a conclusion, correct? And I haven't heard a conclusion.

DR. BELSITO: Well then, I would say that it's insufficient for concentration of use of what we're adding on.

DR. BERGFELD: Okay.

DR. EISENMANN: But we were never asked to do a concentration of use survey, yet, on some of the ingredients; so, it's hard to make it to be a tentative report.

DR. HELDRETH: Yeah, we can put up the insufficiency, and we could give industry time to respond with that information.

DR. MARKS: So, then it would be an insufficient data announcement.

DR. BERGFELD: Is that okay? Agreeable?

DR. BELSITO: I'm fine with whatever the procedures are. I think this will clear pretty quickly once Carol gets us the data on concentration of use. But it's hard to say "safe as used," when we don't know how the new ones are used yet.

DR. HELDRETH: Alternatively, we can concede that this can just be considered a report strategy, at this point. And if you agree with the strategy, then we will create a new report that comes back to you.

Synthetic Amorphous Silica and Hydrated Silica – Expert Panel for Cosmetic Ingredient Safety Meeting Transcripts

DR. BELSITO: I'm fine with that.

DR. BERGFELD: So, it's just a reopen.

DR. MARKS: And then you wanted to include, of the add-ons, Ron Hill had a question with the silver. You weren't happy with including that as a no-brainer on the add-ons?

DR. HILL: I didn't do it as a no-brainer, but if we're reopening, which we weren't clear we were doing in our session, fully reopening.

DR. MARKS: Oh yeah, we're reopening.

DR. HILL: Okay. I didn't know where we landed at the end. Okay, then I think we leave it in for now. But it's not necessarily a no-brainer, it's not clear that we will, for sure, be able to read across, but leave it in for the moment.

DR. BERGFELD: Any other comments? I'll call to question then? All those in favor of reopening, please indicate by raising your hand. Thank you. Unanimous.

DECEMBER 2018 PANEL MEETING – DRAFT AMENDED REPORT/IDA

Belsito's Team Meeting – December 3, 2018

DR. BELSITO: Okay. Silica and silicates. This is the first time we're looking at this one too.

MS. BURNETT: Apologies, I'm going to hand out a last-minute submission from Women's Voices of the Earth.

DR. HELDRETH: Yeah, this one came out -- this submission came in really late, even after we put out Wave 3 to you. Since this report is only in the draft stage, feel free to wait to really go into the details of this most recent submission until the next iteration. We'll include this submission as part of the next package.

DR. BELSITO: Okay. One of the ingredients, before we even go to that, just looking at what we had, is zirconium. And it says the EU has prohibited zirconium, and zirconium silicate and its compounds, in cosmetic products. And it's not even reported as being used. Should we just delete it from the things that we're reviewing?

Or should we include it, but we have no data on it.

DR. BERGFELD: Why did they do that? They're in lots of things.

DR. BERGFELD: Zirconium?

DR. BELSITO: Zirconium. If you look at the cosmetic use, there are no reported uses for the zirconium.

DR. HELDRETH: So you could be insufficient for that one if the other ones are not a concern.

DR. BELSITO: I don't know why zirconium was a concern.

MS. BURNETT: The zirconium, that's in the report, was in the original review. It was in the original review of the silicates.

DR. LIEBLER: I'm not sure I see why it doesn't belong. I mean, chemically -- I mean, you got zinc silicate. You just incorporate the zirconium ions instead of zinc.

Synthetic Amorphous Silica and Hydrated Silica – Expert Panel for Cosmetic Ingredient Safety Meeting Transcripts

DR. BELSITO: And then NICNAS has recommendations for risk management for safe use, for human health or the environment, attapulgite, potassium silicate, sodium silicate, and sodium metasilicate, that I also didn't understand.

MS. BURNETT: So how they do -- if I understand, how they do their risk assessment approach, if it's a tier one -- meaning they don't consider it be a risk to human health or environment, they don't pursue a next-step risk assessment, which delves further into systemic -- they don't produce a health report. So, when you go into their database, you print an ingredient, it will spit out whether it's a tier one, tier two. If it's a tier two, you usually have a report attached to it that has data.

DR. BELSITO: Okay. So Women's Voices of the Earth. Point one, physical and chemical properties.

Morphasilica are composed of very fine particles, 20 microns which aggregate loosely in the air. Again, criticize that we're using an outdated report from 1961.

We had testimony in 2009, that when they're produced, they're 100 micros. And some applications they're milled down to 10 to 20 microns. Websites for cosmetic grade silica commonly advertise their product as having medium particle size of five microns.

DR. SNYDER: So, these are all microspheres?

DR. BELSITO: Yeah, but we state that they're fine particles which tend to aggregate in air. So, don't we already cover that claim? I mean, again, it's not particle size, it's what's coming out of the cosmetic, right?

DR. LIEBLER: I think this is one where it's probably worthwhile for Christina to go through these examples cited in Ms. Scranton's letter, and run them down their links provided at least. And to see how these relate to cosmetic ingredients that are used, in industry. And if we need to revise our particle size discussion, we can do that next time we meet.

DR. BELSITO: I mean, all the criticisms have to do with, material as supplied can have a particle size of less than ten microns, but not the material as used in a cosmetic product. So, if you look at each criticism, that's what it is.

DR. LIEBLER: Yeah, there's two issues in this letter: one is the particle size stuff, that goes the first page and a half. And the second is whether or not crystalline silica is present in cosmetic products. She points to data recorded with the California Safe Cosmetics Program that appears to contradict the assertion, in our report, that only amorphous silica is used. So, that also needs to be chased out.

MS. BURNETT: I did a little searching this morning; I went to the two links that they gave us. The one that is the California database, they have -- when you just put in silica, it comes back with both amorphous and crystalline as one ingredient. It doesn't differentiate the two.

DR. KOWCZ: Could that be the reason why they're reporting it?

MS. BURNETT: I think they're lumping it all together in California.

DR. SNYDER: We went through this before with the fumed silica versus the silica fume; one is crystalline and one's not, right? We talked about that previously.

DR. LIEBLER: So we need to -- we need to make sure that -- if this is a categorization error by lumping all silicas together, in that database, that that could be established.

MS. BURNETT: I'm not sure how to flush that out, but we'll figure --

Synthetic Amorphous Silica and Hydrated Silica – Expert Panel for Cosmetic Ingredient Safety Meeting Transcripts

MS. KOWCZ: I think we need to look into that, because I think if it is lumped together, then the companies that are reporting silica are just reporting silica, because they need to -- they will not take the chance of not reporting it.

MS. BURNETT: From what I can see, there's no way to designate it as one or the other, it's just one. They went ahead and categorized a thousand products with silica in it.

DR. LIEBLER: It should be possible to determine that.

MS. BURNETT: Determine?

DR. LIEBLER: It should be possible to determine whether either the entry field, for entries for those ingredients, are limited to just silica; and it includes both, and so it gets tagged both ways, automatically, upon entry, or whether or not it's just lazy reporting by the companies.

DR. KLAASSEN: Plus there are three or four other websites that she quotes here. We need to look at all of those closely. We were given the impression that what really is used in cosmetics is ten microns and larger. That when they did these studies, like in animals, they even "ground" them down to be five microns. We need to know, absolutely for sure, what's going on here. What is the size? There's a world of difference between five and ten.

DR. EISENMANN: But even if the size is five, as you put it in -- as you put it with other things -- as you put into product, final product, the particle size of the final product is what matters.

DR. KLAASSEN: In that case, we need data.

DR. LIEBLER: And that's true, but yeah, I mean, it's true and it's very reasonable to say that. But, if we don't have any data to really support that, that if you put in, let's say, ten micron distribution, plus or minus five, into a product and then you measure the particles that result in the final formulation, then it's like 50 and up. It would be great to have data to support that. It's certainly reasonable to assume that that could happen. But in the absence of any data we can hang our hats on, it would come across as wishful thinking.

DR. SNYDER: I had a logistics question. Why didn't those come up in your search? Those ones that she found.

MS. BURNETT: They're manufacturer websites. I don't necessarily -- I have -- I'm still reorganizing a report from its original format, and I do have some outdated data sheets. But when I went to go verify that those were still good, they were no longer -- the links were no good. The thing is, is that they label -- their product manufacturers give a name to their products, so it's harder to search for them. So, it's a general Google search that you have to come up with in order to get a silica manufacturer, and it's kind of cumbersome.

DR. SNYDER: Okay. Thank you.

DR. LIEBLER: Does your search include that California Prop 65 database?

MS. BURNETT: No.

DR. LIEBLER: Okay.

MS. BURNETT: Should it?

DR. LIEBLER: I don't know. I guess that's a question I'm asking.

MS. KOWCZ: That's where she's getting the information.

MS. BURNETT: Yes.

DR. LIEBLER: Okay.

DR. HELDRETH: I think we'll have to determine if that's a credible source even.

DR. LIEBLER: Well, you know, it would be good to establish that. Because if that's a site that's being used -- you know, that would be mined and generate data that's going to contradict us over and over again, I mean, it's an unforced error not to look. So, we should be looking at that and evaluate the reliability so we can determine how to deal with this, because it will be coming up again in the future, I suspect.

MR. GREMILLION: That's a California government site. It should be fairly credible you'd think.

MS. KOWCZ: Yeah, but also, she mentions that some of the websites, of the cosmetic suppliers, are saying that's crystalline silica and it needs to require warning language. I don't think, normally, a supplier would tell a manufacturer what they need to say or not say. So, that's a question as well.

DR. HELDRETH: So, we'll include those in the response document that you see in the next panel table iteration of this report.

DR. BELSITO: When I looked at this, I was ready to go safe as used when formulated to be non-irritating, and discuss, extensively, the respiratory issues. But are we now saying that we're insufficient for information on the respiratory issues?

DR. BERGFELD: Particle size plus. Don't you have to have --?

DR. BELSITO: Well, that's the respiratory issues. Is it inhalable?

DR. BERGFELD: Okay.

DR. KLAASSEN: I agree.

DR. BELSITO: So, insufficient for understanding of particle size and formulation, which we're not going to get.

DR. EISENMANN: But in other products, is it safe when formulated to be non -- so you're concerned about spray and some powder -- and loose powder products?

DR. BELSITO: Yeah, we could say safe when formulated --

DR. EISENMANN: For like in toothpaste. I mean there's a lot -- like silica. That's a big use for si- for like sodium silicate, and sodium metasilicate were used in like hair bleaching products. It would be nice to have the insufficiency carved out, more specifically, so that the other uses are safe, or put safe when formulated to be non-irritating, if that's where you're headed.

DR. BELSITO: I mean, the real issue is, yeah, we know they can be supplied at less than ten microns. The question is, is what happens when they're put into formulation? Isn't it really a more stringent conclusion -- we're not going to get data from every single formulator for aerosol products as to what the particle diameter size is. We've been doing this for -- safe when formulated to be non-irritating, safe when formulated to be non-sensitizing, safe when formulated in aerosol products so that the final aerodynamic diameter is whatever.

DR. LIEBLER: Is non-respirable.

DR. BELSITO: Is non-respirable.

DR. LIEBLER: Yeah, we never use that, but I was just thinking the same thing. We either do that in the conclusion or we heavily emphasize it.

DR. BELSITO: No, we put it in the conclusion, because we're never going to get the data on all the products that are respirable.

DR. LIEBLER: I'm okay with that. We could have a new -- this might be something that we might need to utilize more often than a boilerplate, for aerosols. When we know we're not going to get the data; when we can't really arrive at a definition of safety. And so much of it will hinge on how the product comes out of the bottle's nozzle whatever, in the final formulated product. And that's really all up to the manufacturer.

DR. BELSITO: So, I mean, safe as used when formulated to be non-irritating and non-respirable.

MR. GREMILLION: What does non-respirable mean?

DR. BELSITO: Less than ten microns.

DR. LIEBLER: The particles can't get down into the lungs.

MR. GREMILLION: No, I understand-, but where would you draw the line on that? My understanding is that a lot of these products have at least one percent, or whatever, that's less than ten microns. Would you define that?

DR. LIEBLER: If we took this approach, we would need to probably put that into our boilerplate document that we're currently working on. And then also, probably, have that in the discussion, drawn from the boilerplate document, that would explain the relationships between particle size and respirability. And then the thing left for us to determine, is do we want to put some kind of a threshold on that?

MR. GREMILLION: It seems different than formulated to be non-irritating, where that seems like something that's either irritating or it's not irritating; whereas, respirable, everything's going to be a little bit respirable.

DR. LIEBLER: One of those endpoints are analogic.

MR. GREMILLION: Okay.

DR. HELDRETH: So, just to be clear, if it were small enough where we believe it will enter the lung, are we considering whether or not there would be some sort of systemic absorption; or are we talking about irritation or sensitization to the lung?

DR. LIEBLER: So, in the case of silica, that appears to be the issue.

DR. HELDRETH: Irritation or sensitization of the lung?

DR. LIEBLER: Oh, I'm sorry.

DR. SNYDER: Deposition into the lungs.

DR. LIEBLER: Deposition, and lung and toxicity, the results for that.

DR. SNYDER: They have a lot of data. But some of it we don't know the particle size. Or some we have particle size, some we don't. But there's clearly an effect.

DR. HELDRETH: Okay, I just want to be clear on that. Because for silica ciliate, we previously concluded safe when formulated, and delivered in final product not to be irritating or sensitizing to the respiratory tract. But, if we're talking about systemic absorption, that's a different thing.

Synthetic Amorphous Silica and Hydrated Silica – Expert Panel for Cosmetic Ingredient Safety Meeting Transcripts

DR. SNYDER: That's what we discussed when we talked about aerosols. There's a big difference between experimental conditions and consumer conditions of use.

DR. BELSITO: So, what are we saying tomorrow? Non-irritating, non-respirable, and we need to define non-respirable in our boilerplate?

DR. SNYDER: Correct.

DR. LIEBLER: Yes, I agree.

DR. BELSITO: Okay.

DR. SNYDER: Dr. Marks is presenting.

DR. BELSITO: All right. Good.

DR. SNYDER: We're off the hook.

DR. BELSITO: Okay. Well no, we're not off the hook.

DR. KLAASSEN: Sort of.

DR. BELSITO: Okay. We are done, unless there's anything else.

DR. BERGFELD: So, if you can't modify your boilerplate, or you can't address the inhalation -- if we can't modify your boilerplate, or you can't rectify your use and formulation, what will you do, go unsafe for that -- safe sprays or inhalation?

DR. BELSITO: Unsafe for inhalation. But I don't think we're going to need do that. We'll see.

DR. SNYDER: Insufficient.

DR. BELSITO: Insufficient, yeah.

Marks' Team Meeting – December 3, 2018

DR. MARKS: And let's see. The next ingredients are silica and silicates.

MS. BURNETT: Are you ready for another Wave? We had a late comment submission from Women's Voices of the Earth.

DR. SHANK: We need to have control over -- we love to have data and information, but we need time to consider it.

DR. HELDRETH: I agree. And I wanted to add the comment of, since this is not a final report, we can add this as part of the next iteration to that report package; and you can take time to consider these comments, in detail then, if you choose.

DR. SHANK: Okay. I like that.

DR. HELDRETH: We just wanted to -- since it came in, we wanted to provide it and make sure you have it.

DR. ANSELL: And we would appreciate time to read it, too.

Synthetic Amorphous Silica and Hydrated Silica – Expert Panel for Cosmetic Ingredient Safety Meeting Transcripts

MS. BURNETT: We did consider holding it, but one of the points that was made by them, I thought was a little -- that needed attention, potentially going into either a comment period or into an IDA period, where we could research more. But that's -- otherwise --

DR. ANSELL: Which particular one was that?

MS. BURNETT: The comment about the crystalline silica.

DR. HILL: Yeah, my concern, in general, related to what you all just said, was that we're calling this an amended report, but we're adding in a whole mess of new ingredients. And we aren't capturing, in this report, all of the information from previous ingredients in the other reports.

We're saying, here's this report. And then, if you go through the report and you look, you see information. Really, it's all silica, or -- I mean, a very restrictive set there. And we're adding in how many new ingred- -- 23, isn't it, or some large number of --

MS. BURNETT: Well, original report was the 17 silicate ingredients; and then, the panel chose to reopen to add in the three from another report, and then the nine from the silica report. Nine or Seven -- nine. And then a few just new ones that haven't been reviewed.

DR. MARKS: Well, 15. So, there are 23 additional ingredients added. Nine that were previously reviewed by the panel, 15 that have not been reviewed, so that's the 23. So, it's 17 from the original report in '03, to adding some ingredients that had previously reviewed, plus the ones that have not been reviewed.

MS. BURNETT: There was 15 that --

DR. MARKS: So, the total of 40 ingredients.

DR. HILL: And then, chemically, there's a lot of diversity in those ingredients. As I was going through it, I'm saying, this doesn't feel like an amended report anymore, it feels like a new report. And that's fine, but it --

DR. MARKS: At this point, we have in front of us, a draft-amended safety assessment of silica and silicate ingredients, containing the 40 ingredients we just talked about.

We're at the point, do we go ahead and move forward with a conclusion of the tentative amended report, safe when formulated to be non-irritating; or do we issue an insufficient data announcement? And obviously, we'll be able to address the Women's Voices for the Earth at the next review of this, if we want, unless you want to take a few minutes and look over the letter.

MS. BURNETT: While we were discussing the earlier ingredients, I did go and look at the -- for the crystalline silica comment that they made, saying that they did research and they see that it's being used in cosmetics --

DR. ANSELL: On 484, yeah.

MS. BURNETT: -- I did go to the two websites that they proposed. And the one, when you just put in silica, it comes back as only one ingredient matched, and then it goes, then, to say that they're synonyms. Crystalline is the same as amorphous, is the same silicon dioxide.

DR. ANSELL: There are many errors in the 484 database. For example, no one's actually using cadmium as an ingredient. Ethylene oxide is not an ingredient. People have -- and there's no mechanism in which to correct the filings. So, whereas I find their database quite user-friendly, the quality of the data is somewhat questionable.

MS. BURNETT: And it's also -- when you click on the word silica, silicon dioxide, amorphous silica, microcrystalline, it then talks about how it's manufactured from quartz and crystal (inaudible). But according to the data we have, these silicas that are used in cosmetics that are synthetically derived.

I think the CAS number is generic and it applies to both the crystalline and the amorphous type. I think I remember that somewhere in the report.

DR. ANSELL: No, no. Obviously, I've not had a chance to look at --

MS. BURNETT: Oh. So, I don't know if that's causing their error in their database.

DR. ANSELL: Well, no. I -- yeah. I mean, I've not had an opportunity to look at this. But we've looked at the California Safe Cosmetics database, quite extensively, and it has some useful information. For example, many cosmetics are white. Close to 90 percent of the filings are for titanium dioxide. But it also contains materials which should not have been reported, because they're obviously not being -- well, they best not be being used as cosmetic ingredients, heavy metals.

There's no assessment, on California's part, as to the accuracy of the any of the filings. So, we find it an interesting database, but I don't know that it's interpretive to this extent. Even the listing of materials, California points out, are listed because of data which may not be relevant to cosmetics, may contain ingredients which are not used in cosmetics, or used in cosmetics, and not present a risk, because they do not do any type of risk assessment. So, it doesn't surprise me that silica might fall well within that context on the stake or --

MS. BURNETT: Okay. I was just -- that was the main thing I was concerned about, coming out of coming out of the memo. I know, with the micron size, we were reworking the aerosol. And I didn't feel that that was an immediate need for attention by the panel. The crystalline definitely was going forward.

DR. ANSELL: But we should definitely read the letter, and prepare a thoughtful response; and hope that their response to our response is as thoughtful.

DR. HILL: So, just a general -- again, in looking at this and saying, how is this an amended report? There are quite a few substances in here. I should be able to go ingredient by ingredient if I'm going to conclude safe at some point, and say, what is this stuff?

And that got me to thinking, somebody is selling this ingredient to formulators who are formulating it. There will generally be a lot of information in their information sheets, whatever they're using for their marketing materials, about, what is this stuff? How does it behave? And I don't feel like, sometimes, we get that information. And I don't know why we don't get that information, really, from anybody who's vending -- I mean, principle. But at least, I should be able to answer the question, substance by substance by substance, what is this stuff? I see a name. But in general, when it's sold, what is the particle size? In general, when it's sold, what's the chemical stability? In general, if you put it on mucus membranes, how will it react chemically?

All those information relate to and -- is a phagocytose. So, if macrophages are swallowing the stuff, where does it go? Do we build it up in lymph nodes? All those sorts of things. But the least fundamental question is, chemically, what is this stuff? And I don't get that, other than just, okay, it's got calcium and iron and zirconium. Probably not -- Zirconium is talked about in there, but anyway.

So, in terms of data needs, I need enough information in each ingredient if I'm being asked to read across. Because they're clearly not all silica. Silica is just silicon and oxygen and nothing else. But we do have some zeolites and clays, and so forth in there, so that does potentially allow read-across if you have more information.

DR. MARKS: Ron Shank?

Synthetic Amorphous Silica and Hydrated Silica – Expert Panel for Cosmetic Ingredient Safety Meeting Transcripts

DR. HILL: And again, how to capture it. Because it is -- that's the situation. What I put is, we have a lot of x's in the boxes, on the profile page, that are not captured in this particular report in any way whatsoever. It's, go out and read that report, and that report, and that report, and that report. And I'm not sure we should put together a report that way.

I mean, I realize we don't put the whole substance of the previous reports in there, but there should, some way, be data that's captured either tabulated or something, so that we can look at this report. A reader can look at this report and make conclusions about read-across, if that's what we're being asked to do, which we are. So, there are at least summaries of other ingredients in this report, so that I'm not just looking at silica, silica, silica, silica, silica. But that's me.

DR. MARKS: Tom?

DR. SLAGA: I didn't have any concerns related to the ingredients, but to me they are the type of ingredients that we had reviewed in the past. And as you said, this is a reorganized -- most of them are safe already that we have studied. And we're only dealing with 18, I felt, that were not reviewed, and that there was sufficient read across for those; not every one, but enough data to support that these are safe.

DR. MARKS: Ron Shank?

DR. SHANK: I kept the whole group together.

DR. HILL: I concur.

DR. SHANK: I thought there was very little sensitization data and we need more.

DR. MARKS: Interesting.

DR. SHANK: And some of the use concentrations are very high. 80, 100 percent, et cetera.

DR. MARKS: Yeah. Kaolin at 53 percent, silica at 82 percent. I also had very little sensitization data. But then, when I go back and look at, there are just no alerts, and silica is not a sensitizer. And those had been reviewed before.

So, I kind of felt we could go ahead as one of the conclusions in past, safe when formulated to be non-irritating. There was some concern about irritation. So, I felt sensitization would be okay in this case, even though it's not at a high concentration. But we do have sensitization data at, like, 50 percent on them, even though 83 is not 50 percent. But a local lymph node assay --

DR. SHANK: So it's not like palmitic acid -- palmitate?

DR. ANSELL: No. It's more like sand.

DR. SHANK: No, I'm just saying, the sensitization -- last ingredient, we had it --

DR. MARKS: Yeah, I know. I agree. That's it.

DR. SHANK: We had it at one level, but not a little bit higher. Now it's okay, because it's sand?

DR. MARKS: Yes. Essentially, yes.

DR. HILL: I need to qualify my earlier remarks by saying, I don't have any serious toxicological concerns with any of these, even by name only.

DR. SLAGA: It's just enough -- enough on each ingredient.

DR. HILL: But I still have the fundamental thing that if I can't answer the question, what really is this stuff, how do I read across to it and clear it? And I don't know why, if somebody's selling this, we don't have information as to what is this stuff, in every single instance that it is being reported to being use. And if it's not reported to being use, why do we clear it for safety as sufficient? We leave it insufficient until somebody comes forward with the information we need to answer the question, what is this stuff?

So it's kind of a due diligence question for me. I wrote, for example, what do we know about the thermal stability? I was even curious -- from the other end, they, apparently, have excluded the ones that have zirconium in them in Europe, I believe. And I looked and said, well, why? That zirconium's not coming out, so what's the problem? I often rail against pseudoscience because I abhor pseudoscience.

DR. MARKS: It's interesting, Ron, I had that initially. And then when I went back and reviewed, I felt the same. This is sand, even though it's not at the concentration use, I clinically didn't feel that it would be an issue.

DR. SHANK: That's fine.

DR. MARKS: Yeah. And my main, when I looked over at -- besides what you were talking about, Ron Hill -- is are we happy with the inhalation concerns that have been raised? Is there any issue?

DR. SHANK: There are a lot of studies, but most of those studies were designed to get into the deep lung. The particle sizes aren't given, but they did have alveolar effects. So, they're interesting from an inhalation toxicology point of view; but I don't think they relate to cosmetic use, because the exposure would be much, much different.

DR. ANSELL: We also have to be careful. They're looking at lung defects, but they're not truly inhalation studies. Most of them, to get these doses, were instilled.

DR. SHANK: Right.

DR. ANSELL: So, it's not really an inhalation exposure, per se.

DR. SHANK: Well, yes. The toxicologist put instillation in inhalation because, that way, they know they get it in there by ramming it down.

DR. ANSELL: Right. Yeah.

DR. HILL: But it's well to be thinking about that appropriately, because silicosis is a very real thing. And for somebody who was using fumed silica multiple times, on an almost daily basis, all the time, and be real careful how we handle it and tell the grad students how to handle it, we have to make sure that we --

DR. ANSELL: Right. It's relevant to hard rock miners.

DR. HILL: It's relevant to chemists working in labs, filling columns with silica all the time, every day, which, as I said, I was doing. So, 10 micrometer, 20 micrometer, all the time, with fines in there that are very -- go up into the air and that you don't breathe.

DR. MARKS: So, I think, for me, that needs to be explicit in the discussion, that the inhalation concerns are not relevant to the cosmetic use. Okay. I'm gonna go ahead, tomorrow, and move that a tentative amended report of these 40 ingredients, 17 previously reviewed and the 23 add-ons, are safe when formulated to be non-irritating. And we'll see if the Don's team has any concern about sensitization.

Point well taken, Ron Shank. It's a -- yeah. What can I say? I'm leaning, in that previous one, to say the clinical experience. Okay. And then, Ron Hill, you'll have comments. Okay. Let me go ahead and close this. Save it.

DR. SHANK: So what's gonna happen with this new --

DR. MARKS: Oh, we're going to -- oh, thank you. I should -- we're going to address that at the next -- at least our team is going to address it at the next meeting, unless you all want to take a few minutes and read it. But I think Christina or Bart are going to have to draft a response, just like Jinqiu has for another letter that we did get.

DR. SHANK: We could just respond that the panel will consider --

DR. MARKS: Yeah. But I think we have to go, as we've done in the past, point by point. And we'll look at that the next time. This is not the last time we see these ingredients.

DR. HILL: Right. So, in clarification, is this a draft tentative amended report? It just says draft amended report.

DR. MARKS: Just what I said, tentative amended report; which means it'll go on to the next edition, will be the final.

MS. BURNETT: We treated it as if it was a draft report. So, what it comes out of today would be -- if you feel that it's safe as used or --

DR. MARKS: Yeah. That's what I -- safe when formulated.

MS. BURNETT: It will be issued as a tentative amended report.

DR. HILL: So, the next iteration would be, essentially, a final amended report.

DR. HELDRETH: Next time you see it, it'll be a draft of the final.

MS. BURNETT: It'll be a draft.

DR. HILL: But if there was insufficiencies, it'd be a minimum of two more rounds?

DR. ANSELL: If there are insufficiencies, in a review, I would argue that the material should be removed. This is not a first iteration. So, if we've added materials, in which the data doesn't support them, then my answer would be that they shouldn't be in this report. Not that we need to find new data or materials.

DR. HILL: And that's why I asked the question, because how do I know today, when I can't answer the question, what is this stuff, for 15 ingredients that are in here? That's the point.

DR. HELDRETH: Yeah. If we do the assessment and we find that information is lacking, then certainly the assessment is already occurring and we should conclude that there's insufficiencies there.

It's at the discretion of the panel, that any specific ingredient, the review of which may otherwise be deferred, for whatever reason, shall nonetheless be included, at the discretion of the panel when other chemically related, or otherwise conveniently grouped ingredients, are considered. That's the way our procedures read.

DR. HILL: Read it again, one more time.

DR. HELDRETH: Any specific ingredient, the review of which may otherwise be deferred, should nonetheless be included at the discretion of the expert panel, when other chemically-related, or otherwise conveniently-grouped ingredients, are considered.

DR. HILL: But does that apply to amending reports? Or is that first --

Synthetic Amorphous Silica and Hydrated Silica – Expert Panel for Cosmetic Ingredient Safety Meeting Transcripts

DR. HELDRETH: That applies to any decision the panel wants to make. Basically, at its discretion.

DR. ANSELL: Yeah. But we can't move it to a final stage, because it's an amended, and then have materials, which there's a material deficiencies --

DR. HELDRETH: This is a draft report. It would go out as tentative if they give a conclusion. If there's insufficiencies, this would go out as an IDA.

DR. HILL: Okay.

DR. MARKS: Well, I'm gonna propose -- move that we send it out as a tentative amended report, not as an insufficient data notice. Good?

DR. SHANK: Okay.

DR. MARKS: Yeah. And then, Ron Hill, you can --

DR. HILL: I object.

DR. MARKS: Yeah. You can.

DR. HILL: But I don't think I'll be the majority opinion. I'm just -- I object.

DR. MARKS: Well, we'll find out. Let me go ahead and save this.

Full Panel Meeting – December 4, 2018

DR. MARKS: So, at the June meeting this year, we reopened a report from 2003, in which the conclusion of 17 silicate and clay ingredients were found to be safe. This amended report now would have 40 ingredients: the 17 that I mentioned we previously reviewed and 23 add-ons, of which 9 of those had already been reviewed. Our team felt we could move forward with a tentative amended report with a conclusion, safe when formulated to be non-irritating.

DR. BERGFELD: Is there a second?

DR. BELSITO: Trying to get to my --

DR. BERGFELD: Okay. We'll wait for you.

DR. BELSITO: We had some issues with respiration. And we thought safe as used when formulated to be non-irritating and non-respirable, with an extensive discussion of respiratory issues. I'll turn that reason over to Paul and Curt.

DR. BERGFELD: Paul?

DR. SNYDER: I don't recall the non-respirable component yesterday.

DR. KLAASSEN: The non-respirable really boils down to what is the size of the particles that do enter the respiratory tract. At one time, we were under the impression that they were all at least ten microns in size. But now there appears to be some information that there might five microns, at least when it leaves the nozzle.

Then the question is, do they agglomerate in the air on the way to the lung and become larger? It really is a problem of having knowledge about what is the size that we're really talking about here. It's not clear to me what it is. I think we need more information. Maybe the other team has a better handle on that than I do.

DR. LIEBLER: I think I might have been the one who floated the formulated to be non-respirable construct here. This reminds me, in a lot of ways, of the sensitization situation; where we have, for example, botanicals that we know contained a sensitizing ingredient, but may or may not be sensitizing, depending on whatever else is in the product formulation and perhaps some other conditions.

We can't really know that in all cases. We can point it out, but we want to put in the conclusion somehow, so we say formulated to be non-sensitizing. It's not that we're punting on the issue, but we realize that we don't have the data to anticipate what would be the circumstances with all of the individual products and their uses.

I think a similar situation applies to particles and inhalation. We're going to talk about the inhalation aerosol precedence in a few minutes. But it occurred to me that we're in a similar situation with the aerosols and particles; where we know that there's evidence that the distributions could include respirable particles.

What actually happens, in the product, as Curt just said, depends a whole lot on what else is in the can, or in the jar, and so forth. That's not going to be known by us, and we can't simply say it's safe or unsafe. It might be, and it might not be, it depends on the circumstances. So this seems to set up a circumstance where we might embrace a new construct, where we say formulated to be non-respirable.

It's not intended to punt on the issue; it actually highlights the issue. It essentially says to the industry, you're the people who put the silica, in this case, into your product, and you need to be aware that you could produce -- you are probably very particular about the specifications of the silica, that you order from suppliers to put into your product; but you probably need to be aware of what the particle size, and the potential for respiration of these particles, will be in your product. That's the logic behind this idea, formulated to be non-respirable. I guess, I'd better quit repeating myself.

DR. BERGFELD: Tom.

MR. GREMILLION: It's not clear to me what would be meant by formulated to be non-respirable. Would that mean like an absolute prohibition on particles less than ten microns?

DR. LIEBLER: That's impossible. Because these distributions always contain a tail that include the small number. This is something that perhaps we need to talk about more, what that might be in practice; maybe that goes into the precedence document. Is there a percentage less than ten microns, for example, that might be a useful guideline? I think practically speaking, Tom, the idea would be, the amount that would be respirable needs to be below the amount that we could reasonably anticipate would produce an adverse response in the lung.

MR. GREMILLION: I guess, how would cumulative effects play into that? Because if a lot of different manufacturers have products that, on their own, aren't making -- or contributing to an adverse effect, but people are using multiple products that have small respirable quantities, since together they could produce an adverse effect. I wouldn't know how to calculate that if I was a manufacturer.

DR. LIEBLER: Right. And the manufacturer, in that case, couldn't necessarily anticipate that Ms. Smith is using this face powder, and this spray, and this other thing; whereas, Ms. Jones is only using the face powder. That's almost beyond our purview.

If we, again, go back to the example of the botanicals and sensitization, we can specify, within a particular product, formulated to be non-sensitizing, to avoid stacking up sensitizing ingredients to a level that produces a response. But I don't think that really addresses the possibility that using six different botanical products, over the space of time, couldn't produce a response. In other words, I think there are just some things that are just beyond our ability to control.

MR. GREMILLION: I guess with the sensitizing, it seems like that's not analogous because it's either, there is a reaction or there isn't. But with something respirable, it's like you have to have a lot of something to cause an adverse reaction from breathing it in.

DR. LIEBLER: Both of these phenomena are dependent on exposure and dose.

MR. GREMILLION: I see that in very broad terms, but it seems kind of like a qualitative difference between sensitizing and respirable.

DR. HELDRETH: As it's clear, this would be a new type of conclusion that the panel's putting forth, and that's certainly the panel's prerogative to do that. However, historically, I think the way that we would have handled this, in a conclusion, is to say safe with whatever qualifications for other uses, but that the data are insufficient for use in things like sprays and powders.

DR. MARKS: I'd like Ron, Ron, and Tom to address it. Our team felt that -- at least, if I interpreted our discussion correctly yesterday -- was the inhalation concerns were not relevant to cosmetic use. Did I get that right as the bottom line?

DR. SHANK: Yes.

DR. MARKS: So, after this really robust discussion and concern about sprays and such for cosmetic use, I don't know whether, Ron Shank, you want to address why we felt that that wasn't a concern?

DR. SHANK: The inhalation toxicology data, in the report, was aimed at looking at these silicates into the lung purposefully. It wasn't the kind of study that would apply to cosmetic use. On the other hand, rather than putting that into the conclusion, that they're formulated to be non-respirable, we have to see what the boilerplate is going to be for aerosols. Because that's how we've usually handled it in the discussion, that the use is infrequent and, for the most part, large particles which are not inhaled. We've now put it into the conclusion.

Synthetic Amorphous Silica and Hydrated Silica – Expert Panel for Cosmetic Ingredient Safety Meeting Transcripts

If we start -- first, we add the formulated to be non-irritating; now, formulated to be non-irritating, formulated to be non-sensitizing. Now we're going to go, formulated to be non-irritating, non-sensitizing, non-respirable. Two years from now, we're going to be formulated to be nontoxic, and then we can all go home. I don't want to be facetious.

DR. LIEBLER: Ron, you're messing with my plan. I really wanted to get home.

DR. SHANK: I think it's dodging the issue. We've done it with non-sensitizing because it's usually been mixtures, where you have botanicals; and you have so many things it's hard to pick on any one chemical within the mix. Dr. Belsito explained the non-irritating. That's strictly formulation dependent. That makes sense. I think, I would rather handle this in the discussion and not put a restriction in the conclusion.

MS. BURNETT: If it helps the discussion at all, the original discussions for the 2003 silicates report, and the 2009 silica report have a respiratory component to the discussion section. If you want to look at that language, that's PDF Page 92-93, if any of that language can be reused or amplified.

DR. BERGFELD: Ron Hill.

DR. HILL: I still think that Dr. Liebler's idea is worth some serious and strong consideration, first of all. Second of all, the definition of respirable is a little bit shaky. I mean, we have some idea about that; however, in principle, with these given the idea that we are talking about solid particulates, I presume in all cases, at least we have an idea of what we're talking about. We're not talking about evaporating droplets, except as maybe in propellants, for example, in a pump spray.

My fundamental problem with this report, as it sits right now, is we've got 13 new ingredients in there for which I can't answer the question beyond the basic dictionary description, what is this stuff? I think that if we're doing an amended report here -- and I asked the question yesterday, is this an amended report or is it a new report, because we've got a number of ingredients that we can't answer the question, what is this stuff? So for me, until I get answers to that, it's insufficient on all of those that we don't have those answers.

Because that relates to, it's a difference between crystalline silica versus amorphous silica with fine (phonetic), versus the sorts of things that we actually see in cosmetic ingredients. Those are three different forms of silica. Again, I mentioned that as a chemist working many years, where almost on a daily basis, I was filling silica columns where we had to be very sure not to breathe those fines; that was a very different situation than in a cosmetic ingredient. In most cases, we know if it's face powder, they already present as higher agglomerates; there's not going to be fines in there and we don't have an issue, speaking to the cumulative problem.

But we've had a lot of discussion. We had a very robust, long discussion about the respiration issues, yesterday, to which we in the end didn't come with any firm conclusions other than some lack of information that we still need.

DR. LIEBLER: I just want to say this one thing. My inclination, originally going into this was right where Ron Shank is, that these are not respirable. But then I'm faced with the issue of saying, because why? What are the data that support that assertion, that that's not relevant to cosmetic use? That's where I felt I was tripped up. That's why I'm searching for an alternative way to deal with it.

I think you could also handle this in the discussion. If you wanted to say safe as used but, in the discussion, very clearly point out the issues and the unknowns, and the fact that this is something that manufacturers would need to take into consideration in the formulation, I can live with that too. But as again I was struck by the similarities, even if they're not complete to the formulated to be non-sensitizing, and that's why I made this suggestion. So, I'm glad we've had some discussion about it.

DR. BERGFELD: Paul and then Don.

DR. SNYDER: First, I'm going to qualify by saying, I'm not an inhalation toxicologist. But my comments are related to the fact that inhalation toxicity can be localized. It can be in upper airways, it can be all the way down in

the respiratory tract. The issue with respirable particles is that they get deep into the lung, and now we have a different relative exposure for potential systemic toxicity, that may be different than oral, than pharyngeal, other mechanisms by which there could be exposure.

So, I think we're kind of -- we're not fully understanding the toxicology. And, Curt, maybe you could elaborate on this more. So, the physical properties of the formulation drive where it's going to go, and how deep it's going to go. It's not chemistry, it's not biology, it's just the physical properties of a thing. So we've always used that as a basis to be safe, to be confident that even some incidental exposure through discontinuous use or whatever, is not likely going to result in any significant toxicity. I think that's very different than saying non-respirable.

Because all of a sudden, now, if we have a conclusion that says non-respirable, because it has an aerosol use, all previous report that we've had aerosol use, and we don't have non-respirable in there, are now not compliant with use, right? I think that really opens up a huge can of worms, that I don't think we need to open. Because the old reports clearly state we had data to support that they're non-respirable; and we're not concerned about systemic toxicity from being respirable.

DR. BERGFELD: Don and then Curt.

DR. BELSITO: Just looking how we handled it before, the final sentence, in the discussions, said that the panel considered that any spray containing these solids should be formulated to minimize inhalation. It's almost like a restriction that could also occur in the conclusion.

I guess my concern -- and I brought this up with Alexandra yesterday -- is that -- and I'm, again, not a respiratory toxicologist, nor am I a spray physicist or physical engineer. But I think we've been operating under the assumption that there are hairsprays and there are pumps. Now, we're being told they are different types of delivery systems. There's some spray tanning delivery system that's different. There's liquid spray make-up that's different. And we don't have any idea what the range of particle sizes that those would deliver.

One of the things that I asked for, was that we have someone come to the panel, who understands spray delivery systems, and tells us a little bit about, you know, okay, here's the average particle size from an underarm deodorant pump. Here's the average particle size from a hairspray. We could maybe get to this issue by understanding what type of delivery system is most likely to generate the smallest number of aerodynamic particles.

I think that our assumptions that there are just two types of sprays and, you know, pumps deliver a larger aerodynamic sized particle than a hairspray, there are other spray delivery systems that we don't have information about.

DR. HILL: And the other --

DR. BERGFELD: Curt and then you can comment.

DR. KLAASSEN: Well, I think we've discussed most of the issues here. I guess I would -- the bottom line here for this report, I think, I would be more in agreement to keep it the way it was in the previous addition; that is emphasizing the possibilities here, but not putting it in the final conclusion.

DR. BERGFELD: Tom and then Ron.

DR. SLAGA: I agree with Ron Shank and Curt. I think we have to go on what we did before. And just have that, and maybe add a little bit more to the discussion that there is some little concern. But I would not put in the conclusion.

DR. HILL: Yeah, I was just going to point out, again, that one of the chronic -- no pun intended -- issues that we have, is making sure that we distinguish between solid particles of things like zeolites and the like, silica, and liquid droplets that have compounds in them. Sure, they may become solid briefly, as they're flying through the air and the

solvent is evaporating, but can redissolve in the lungs; and we have -- well, we don't have any toxicology related to that.

It seems like in all these discussions of particle sizes -- and I mentioned, although technically, there is no reason that when I think of a droplet, I think of liquid, when I think of particle, I think of as a solid, which is actually not accurate, you could have a liquid particle. But anyway, we have this muddling of things.

In this particular ingredient set, I presume, we're dealing with things that are solids across the board. So, I want to go back to this particular ingredient and make sure we're thinking in that terms. Again, we have 13 things in here where all we have is the description and still no, what is this substance? So, I don't know why we're not insufficient for getting information about the properties of these compounds.

DR. BERGFELD: Thank you. Dr. Marks, you had a motion with not seconded. You want to --

MR. GREMILLION: Could I ask. There's this letter from the Women's Voices for the Earth that --

DR. BERGFELD: We're going to address that under aerosols. Thank you. Do you want to propose a motion?

DR. MARKS: I'll address the letter in a minute. I want to get to the discussion. I'll repeat the motion that our team proposed. That's that this is a tentative, amended report, 40 ingredients with a safe when formulated to be non-irritating conclusion.

DR. BERGFELD: Is there a second? Seeing none, is there another motion?

DR. BELSITO: I like Bart's idea of saying the data is insufficient to determine the safety for products that could be inhaled. I'm still very concerned that I don't understand the technology of sprays, and the size of particles that can be delivered.

DR. BERGFELD: Is there a supporting motion for this, go insufficient?

MS. BURNETT: It would have to go as an insufficient data announcement with what you need specified.

DR. BELSITO: What we need specified is the range of particle size in products that are used in sprays and face powders, that one would expect in terms of how these are being used.

DR. BERGFELD: Would you need the delivery systems?

DR. HILL: If you're asking for range of particle size, that would be implicit as far as I'm concerned.

DR. BERGFELD: Okay. All right. So, the motion has been restated. Is there a second?

DR. MARKS: I want to hear Ron Shanks comment.

DR. SHANKS: I think the issue of inhalation toxicity with these ingredients can be handled in the discussion, as we did before, and not in the conclusion. We all agree it is a concern, and I think it is how to state the conclusion. If we start putting it in the conclusion now, then we have a huge back load; every time there is a spray or aerosol, we're going to have to put this into the conclusion, because we don't have a lot of data for every ingredient. That's why we have this precedent document that discusses this in great detail. Particle size is not the only thing that determines pulmonary exposure.

DR. LIEBLER: I'd just like to say that I appreciate my colleagues' thoughtful consideration of my suggestion. I think that it's not going to fly, and I've heard a lot of good reasons why it probably shouldn't. I still think the choice between us right now, is whether to say safe as used, and we'll try and craft the discussion to deal with it; or whether we should say insufficient, at this stage, for this report, and see if we can squeeze out more information that could

end up helping us inform our discussion later on anyway. So, that's why I kind of lean in the direction that Don is proposing, at this point.

DR. BERGFELD: Is there a second to Don's motion?

DR. MARKS: Second. I'll withdraw our team's initial motion.

DR. BERGFELD: Well, it wasn't seconded, so it did not go forward. So, we're going to have any other discussion? You want to know --

MS. BURNETT: In addition to the range of particle size, for products that are sprays and powders, what additional items would you like in the IDA?

DR. BERGFELD: Do you want to request a characterization of the chemistry?

DR. HILL: I do want information about these ingredients.

MS. KOWCZ: Can I just make one comment?

DR. BERGFELD: Yes. Alex.

MS. KOWCZ: Well, we just really want to know, exactly, what is the ask from the panel?

DR. BERGFELD: Christina has the list, we'll let her read it.

MS. BURNETT: Range of particle size for products that are used in sprays and powders. And chemical characterization of the new add-ons.

DR. HILL: The ones for which we don't have data, new or existing, honestly.

DR. LIEBLER: So, chemical, physical properties is thin, it's just silica and hydrated silica; it's none of the zeolites, for example. Method of manufacturing is just silica and hydrated silica. Those are synthetically produced. I don't know, is everything synthetically produced now? Or is some of it mined? Composition impurities, again, is just silica. This is a big report with a lot of ingredients, and we've got just the tip of the iceberg.

DR. HILL: Well, this particular report, that was an issue I had yesterday, is relying on four or five previous reports. There's a significant number, I think, they're referencing, but it's not really brought in and captured. What I wrote in here was there were a lot of x's in the box, indicating we had data that don't directly show up in this report.

So really, some way of doing data capture without having to bring over all the language and all the information from those previous reports. I mean, we're relying on those. And whether information exists in the previous reports, just at some -- I don't know if there's any way to briefly summarize, in a table or something, to indicate what's there in the previous report so that the reader could at least use this in some self-contained fashion.

For the new ones, where we don't have information -- and there are things that are mined. There are zeolites that are mined, there are clays that are mined, there're things that are not synthetically produced, but they may be processed. I don't necessarily know what that processing is, honestly, in each of those cases. But at least some sense of what the composition of the things are, and maybe the source, if it's applicable.

DR. BERGFELD: So, a clarification on this request; physical chemistry of the unknown ingredients, are we adding methods of manufacturing impurities since we're asking?

DR. LIEBLER: Yes.

DR. BERGFELD: Anything else?

DR. HILL: Let's see what we get. If we don't get it in some case, and we decide if it's important or not.

DR. BERGFELD: Okay. And then just an editorial that we go back and tabulize all those previous studies for this document. Okay. Don and then Monice.

DR. BELSITO: Just to point out, I went back and looked at concentrations of use. For instance, silica, in an underarm deodorant, can be used up to 10.4 percent, which is not a negligible amount. And we know that underarm sprays will have lower aerodynamic particle size.

MS. KOWCZ: Can I just mention that these are amorphous-hydrated silicas, the ten percent that you're talking about. So, it is dissolved in the formula.

DR. BERGFELD: Thank you.

DR. BELSITO: That kind of information can be brought into the document?

DR. HILL: We have had past presentations on that, but then the situation is different. If it's in a spray, the particles can potentially evaporate, versus it's in a solid underarm deodorant.

DR. BERGFELD: Okay. Monice?

MS. FIUME: Just to clarify for the information on the particle size and for the ingredients; and, Alex, maybe this is what you were getting to. Is it all ingredients that are used in sprays; or are there specific ingredients from that list that you would really like to see the particle size information on? Is there more concern for some than others, or all that are used in sprays or powders?

DR. LIEBLER: I think we should ask for all that are used in sprays and powders. That maximizes our opportunity to get relevant data.

DR. BERGFELD: Thank you. Any additive remarks?

DR. MARKS: Yes. Yesterday we were given a Women's Voices of the Earth letter. Our team decided not to review that letter yesterday. We postponed it until the next meeting. It did elicit some discussion of getting Wave 3, Wave 4, and Wave 5's, at very short notice, and being able to review those thoroughly and think about our responses. I just bring up that point about yesterday. Don, I don't know whether your team felt comfortable reviewing it, but our team did not. Team members, do we have any other comments? Ron?

DR. SHANK: No, I think that the CIR can respond immediately; but I think the panel needs some time to consider how we want to respond. And we haven't had enough time to do that.

DR. BELSITO: Well, I think we discussed it, which is part of the reason why we've come to this conclusion, that we need time to digest what she said and to get a better understanding of particle size in these sprays. So, that was our response to this letter, that at this point we're going insufficient. We will consider her points and come back when we relook at the document.

DR. HELDRETH: On our end, we will make sure we respond to her and let her know exactly what we're doing. Then the next iteration of this report, when it comes back to the panel table, will have this letter and our summaries in there. And any input we get from others about the content of the letter will be included there as well.

DR. MARKS: And then the only other comment I had -- and, Don, you can respond to this if you want. There was little sensitization data with Kaolin used up to 53 percent on leave-ons, and silica at 82 percent on leave-ons. But

there's no alerts in the clinical literature that would suggest these are significant sensitizers. So, I felt we could move on and not be concerned about the sensitization of these ingredients.

DR. BELSITO: I agree.

DR. BERGFELD: Paul, did you have something to say? I'm going to call the question then, to move the question of this is going out as an insufficient data announcement. All those in favor? Unanimous. All right. Thank you for that, again, very robust discussion.

APRIL 2019 PANEL MEETING – DRAFT TENTATIVE AMENDED REPORT/TABLED

Belsito's Team Meeting – April 8, 2019

DR. BELSITO: Okay. Silicates. We've got a lot of information and I thought it was okay, but it's not my area of expertise. We asked about molecular size and we got all these graphs, M, N, R, P, Q, which were 10 microns, but then we're told that became agglomerates and it gets to larger than 100. And I just looked at them and said okay. I'm not concerned about them with skin, so I pass all of this discussion on to you three.

DR. LIEBLER: So going to those pie charts, a lot of those pie charts said that -- up to 50 -- did I read it right? Up to 50 percent were less than five microns?

DR. BELSITO: Yeah. But those were like all the original ones. And then we get this thing at the end that says, okay, that's their particle size. But then when they're put together, they agglomerate and they're all greater than 100 microns, is the way I read it, but I'm not sure. Again, as I said, it's not my area of expertise. So maybe we can have some comments from --

DR. SNYDER: And then also the grouping, because he mentioned the amorphous -- synthetic amorphous, synthetic silica aluminates, crystalline and then natural. I mean, what are the major groupings in this report? Do you have access to our document?

MR. JURD: I'm not sure which. Are you looking at like the phase three, the one that came through?

DR. BELSITO: We're looking through the CIR document.

DR. JURD: Yes.

DR. SNYDER: So we have a whole list here from activated clay all the way to zirconium silicate. And so if you look at that list, what are the high-level classifications that would capture all of those?

MR. JURD: I'm not sure about how they were lumped and how everything was kind of laced together. I can tell you, like synthetic -- I mean, there's a big difference between the synthetic versions and naturally occurring. So synthetic amorphous silica is created from primary particles; very, very small in size. They agglomerate and then aggregate. So, once they get to the larger size, it takes a tremendous amount of energy to separate those.

What the materials that are put on the market, for the most part, are larger particles, you know, between I'm going to say 10 and 80, 90 microns, type size, not in the nano range. The primary particles are typically in the nano range. There's a lot of focus on that in other areas, but those do not typically exist, or in large, easily measurable -- one of the difficulties the industry is having right now is actually measuring materials at the very, very small level.

And a lot of this is due to the definitions that are out there by a lot of various regulatory agencies looking at, you know, what defines material like nano in Europe. Silica, by at least one group, has been defined as nano structured, not a nano material, because it's composed of lots of little small things glued together.

DR. LIEBLER: So are silica and hydrated silica the only synthetically produced ingredients on our list, which on our document is PDF page 93?

So our methods of manufacture section, which is right after this, is at this point somewhat incomplete. And it does indicate that those two, silica and hydrated silica, that are used in cosmetic products are synthetically produced. But it doesn't give much information about the production of any of the others.

MR. JURD: I know for a fact that a lot of these are synthetically manufactured. We manufacture ourselves a lot of the silicates, sodium, the magnesium aluminum silicate is synthetically manufactured, along with a number of the other ones, potassium silicate. Not that I'm aware of, or anybody that I know of, has informed me that they're used in cosmetic products, but they are -- they can be synthetically manufacturing.

DR. LIEBLER: So two of the issues that we have to deal with are the particle size, and the control of contaminants. And of course, particle size and control of contaminants are under full control in the synthetically produced materials. But the materials that are mined and then worked up somehow are not, or not as controlled. And there are some of those on our list, I would imagine things like Fuller's Earth and activated clay and zeolites, although I don't know for sure.

So we have really inadequate information to assess whether these all go together in the report, just from the standpoint of how they're produced.

DR. BELSITO: That's one of the issues that Women's Voice raises in their last paragraph.

DR. LIEBLER: Right. And the other issue about the mined material versus the synthetics are that the mined materials may contain some crystalline silica. I think you mentioned that earlier.

MR. JURD: That is -- it depends on the purity, where it is and --

DR. LIEBLER: Exactly. That's much harder to assess and control, but it's an issue that we need to be concerned about for safety. And so, you know, there are a number of other points made in this memo to Bart from the Science and Support Committee that I'm not sure I agree with, but it sure would be good for us to have enough information to make some judgments about which things actually go together in the report based on the composition and character, physical chemical characteristics of the ingredients, relevant contaminants that are particularly health concerns. And once we have that information, then perhaps we can take a swipe at the issues that are raised in this memo.

So, that's something, at least as a representative of industry, maybe if you can help disseminate that information back. Because I think our description of method of manufacture for these is really incomplete to the point that we can't make the assessment we're being asked to make.

MR. JURD: We can provide data based on what our members actually manufacture.

DR. LIEBLER: Correct.

MR. JURD: I can't go beyond that.

DR. LIEBLER: Well, that's all we care about. That's all we care about because those are the cosmetic ingredients. So silica products that are used for things other than cosmetics we don't care about, and we don't need to know that. But we do need to know about the ingredients that are used in cosmetics.

MR. JURD: We can definitely provide information. I think you've got almost everything on the silica, with some of the other reports. I don't know if that's a true statement. I mean, you might have to confirm for me.

Synthetic Amorphous Silica and Hydrated Silica – Expert Panel for Cosmetic Ingredient Safety Meeting Transcripts

We definitely have good contamination materials, you know, byproducts, impurities. Most of the impurities come in low levels of metals, primarily, from sodium silicate or sulfuric acid. Silicates, pretty much the same thing; low levels of metals, very, very low. And then leftover raw materials, sodium silicate, that sort of thing.

MS. BURNETT: Some of the method of manufacturing is in original report. Since this is an amended -- reopened amended -- review. The clays, it talks about being strip mined.

DR. LIEBLER: But the original report wasn't published.

MS. BURNETT: For silica and hydrated silica, this is --

DR. LIEBLER: That wasn't published.

MS. BURNETT: Yeah. So that one wasn't published. But if you go to PDF page 155 from the 2003 silicate report, it also includes like kaolin and attapulgite.

DR. LIEBLER: Zeolite.

MS. BURNETT: Bentonite.

DR. LIEBLER: Because many of these things are still used, as our survey indicated. Yeah, the method of manufacturing, the current report suggests that there's not much known, and there's actually a lot known.

MS. BURNETT: I can pull that --

DR. LIEBLER: So we need to somehow find a way to bring that in, or at least to summarize it.

MS. BURNETT: I will make sure I pull that in.

DR. LIEBLER: Okay. It could be another table.

MS. BURNETT: Okay.

MR. JURD: I guess what might be a little bit confusing, too, is most of the synthetic silicates, along with synthetic zeolites, you have naturally occurring forms too. You're running into that, I think, across the board. Whether or not naturally occurring material is used for the same sort of applications, I don't know.

I mean, zeolites is a really good example. You know, there's a lot of those manufactured for a broad range of uses. And they're lumped into a general category. I mean, zeolites are defined by the EPA as a statutory mixture. So, silica alumina, cations and anions; so it can be literally hundreds of different types of materials, which can be a challenge.

DR. LIEBLER: So in the current report version, kaolin and magnesium aluminum silicate are listed as containing quartz or crystalline silica. I don't think I'm overlooking any others, unless some of these mineral names are also crystalline silicas but don't explicitly indicate so.

So that's an issue we'll need to address by knowing the levels of impurities to be able to deal with it in our discussion.

DR. BELSITO: But we've done it. So that's an insufficiency.

DR. LIEBLER: Right, yeah. I'm putting this in legal terms. But yes, it's --

DR. SNYDER: So, essentially, we still have the same data needs that we had originally.

DR. BELSITO: Well, we need particle size for silica and silicate, don't we?

DR. SNYDER: Yeah.

DR. BELSITO: Do we need more data on that?

DR. SNYDER: I was thinking more of the composition and impurities, Dan's point.

MR. JURD: For the silicates?

DR. BELSITO: So, basically, we get rid of the first request, which is particle size, for silicate and silica ingredients that are used. We asked for hairspray and powder formulations. We really didn't specifically get that. We got particle size, but not for hairsprays. And we're still not done with the respiratory boilerplate, because we didn't sign off on that. Right? So how do we handle that? We really don't have the first data need either.

DR. LIEBLER: So it sounds like we have some of the information we need. It just needs to be brought into the report from the previous reports and isn't here yet.

DR. BELSITO: No, we don't have impurities or chemical characterization. We have method of manufacture, which is pretty crude. Bentonite, mined ore bentonite, is processed to remove grit and nonswelling materials.

DR. LIEBLER: Right. But Christina just told us that the previous reports have a lot of that in --

DR. BELSITO: I'm reading the prior report. This is page 155, Method of Manufacture, from the prior report. It has data in there. I mean, it has stuff in there. But are you satisfied with, "The mined ore bentonite is processed to remove grit and nonswelling materials"?

DR. LIEBLER: No.

DR. BELSITO: That's what we have for bentonite.

DR. LIEBLER: So we're still insufficient. Okay. Fair enough.

MS. BURNETT: Dr. Liebler, could I ask you, on the data that we received from SASSI, all those different graphs, should that be brought in the report? And if so, what would be a good way of presenting that data?

DR. LIEBLER: I think those data could be presented in the form of a few sentences.

MS. BURNETT: Just a few sentences.

DR. LIEBLER: Because first of all, those particle size distributions -- actually, as I recall, they don't name a particular silica form, do they?

DR. BELSITO: No, they're A, B, C, D, M, N, P, Q, R.

DR. LIEBLER: So just Product A, Company B, and distributions. So what you could do is indicate that industry reported X silica particulate size distributions that ranged from -- medians ranged from X to Y. Or the median was X and the ranges were from A to B. And that's about all you can report. And if we can't associate these with any particular silica forms for any of the ingredients in this report, that's all we can say. It becomes a piece of information that's worth a couple sentences.

MS. BURNETT: Thank you.

Synthetic Amorphous Silica and Hydrated Silica – Expert Panel for Cosmetic Ingredient Safety Meeting Transcripts

DR. BELSITO: So this was a draft tentative amended. So we're now saying that we really got none of the data that we asked for, except for some particle sizes on silica and silicate, but not as used in sprays and powder formulations. But then we heard that when they agglomerate it would take a tremendous amount of energy to separate them.

So, I guess if we combine that statement, we could say that they're not respirable. Could we?

DR. LIEBLER: So they're mostly not respirable. I mean, based on those distributions, it appears that they're not, because the --

DR. BELSITO: Even the small ones will agglomerate, we're told, to over 100 microns. Because some of them, you know, M, N, R, P, Q, were 10 microns.

DR. LIEBLER: Right. Yeah. My impression from looking at that summary was that they were referring to the particle size distributions of the final reduced particles which are already agglomerated. So you get --

DR. BELSITO: Is that true?

MR. JURD: That's -- yes.

DR. LIEBLER: So you get the precursor molecules. They aggregate into aggregates. And then aggregates form agglomerates or agglomerate. Right?

MR. JURD: Correct.

DR. LIEBLER: So aggregates are small-ish, agglomerates are bigger. And that's the final form of these prior to incorporation into any cosmetic formulation.

MR. JURD: Correct. Yeah, you can break apart the smaller pieces without -- well, some amount of energy is required. But once they are at -- form the larger particles?

DR. LIEBLER: Right.

MR. JURD: They're pretty robust.

DR. LIEBLER: Too many bonds.

MR. JURD: Right.

DR. LIEBLER: Too much energy.

MR. JURD: Right.

DR. LIEBLER: Whereas the small particles are smaller, and there's less energy.

MR. JURD: But these all are, you know, the way that it happens, we can't discount that there isn't a tail of smaller material.

DR. LIEBLER: Well, that's what I'm referring to also. It's almost entirely not respirable, but a tail is a tail; and it includes, you know, an indeterminate number -- well, not indeterminate. You can estimate the percentages.

DR. BELSITO: So then, when we're looking at -- like on our PDF from Wave 2, page 73, where we have a distribution curve, and the particle size seems to be peaking at around 7.5 microns, that is what's actually being supplied to the manufacturer?

Synthetic Amorphous Silica and Hydrated Silica – Expert Panel for Cosmetic Ingredient Safety Meeting Transcripts

Or does that further agglomerate and what's being supplied to the manufacturer is going to be over 100 microns? Because my understanding of reading further on was even these smaller ones will aggregate to larger particles. But are you now saying that whatever sample R was, was nanometers, and it's aggregated up to 10 microns?

DR. LIEBLER: No. If you -- I'm paging up in this document, past all these particle distribution graphs, to the text -- or there's a figure that shows the process?

DR. BELSITO: Yeah.

DR. LIEBLER: I remember seeing a figure for -- I think it was the nanoscale material, voluntary submission --

DR. BELSITO: Was it figure three, structural difference -- no.

DR. LIEBLER: The voluntary submission document. Ah, it's in -- hang on. Just scrolling through it.

DR. BELSITO: Wave 2 or?

DR. LIEBLER: It's in Wave 2, the Wave 2 document. I'm getting close.

DR. BELSITO: Is it page 91, reactor feed?

DR. LIEBLER: Yes. Yeah, page 91. So I'm assuming from the description -- so page 91, the figure 1-4 for is the general structure development sequenced during SAS manufacturing and reactor feed has the precursor molecules that form nuclei, which are individual molecule particles, which form primary particles, five to 50 nanometers, which then form aggregates. And that little purple cone shows that that's all happening within the spray zone, I guess.

And then I interpreted this is that these aggregates are forming the agglomerates as the aggregates are being formed. And this is all happening in the reaction vessel, and that it's not happening as --

DR. BELSITO: But some of the agglomerates are less than 10 microns.

DR. LIEBLER: Yeah. One to 250 microns, it says there.

DR. BELSITO: Right.

DR. LIEBLER: And our particle size distributions go down to about one before they appear to zero out.

DR. BELSITO: Right.

DR. LIEBLER: And then the one you just pointed to have a median of --

DR. BELSITO: 7.5 almost.

DR. LIEBLER: Yeah. Anyway, so --

DR. BELSITO: So these are small, even when they agglomerate.

DR. LIEBLER: Yeah. But that's the version of the particle, that's one of the smaller ones. Because some of these --

DR. BELSITO: I understand, but we don't know whether that particle is used in or in a pump or spray. We don't know what the particle is. So then --

Synthetic Amorphous Silica and Hydrated Silica – Expert Panel for Cosmetic Ingredient Safety Meeting Transcripts

DR. LIEBLER: The other unknown is when you put it into a cosmetic ingredient, if those agglomerated particles form anything larger, by combining with other ingredients in the formulation.

DR. BELSITO: And then how strongly do they agglomerate. And then what happens when you spray them out of a hairspray or whatever other sprays they're in?

DR. LIEBLER: Yeah, we don't really know --

DR. BELSITO: So, in essence, all of our data needs that we had asked for before are still unanswered. Because we now know that some of the agglomerates are down to 10 microns. And we also know that we don't know anything about what happens in terms of those that are used in sprays and powders. We don't know which ones are.

And then the next question becomes all the ones that are naturally mined, like bentonite and clay, do we keep those in the report? I mean, this is this is WVE's last question to us. Is this grouping correct?

DR. LIEBLER: I think it's a fair question. I don't know how much better characterization of those we'll have to allow us to make that determination. We've been reporting on these for years.

DR. HELDRETH: Right. So, just looking at this and looking at the history of this, we had ingredients like Fuller's Earth, and, you know, sodium magnesium silicate, already in the original report together. And it's time to review all of those ingredients again.

So really it comes down to two options, if we want to start splitting things up, if we can figure out which one's go in which report, or split them up within the report to make sure that there's clear margins between them saying, you know, we don't want to look at these together. So, I mean, either option --

DR. LIEBLER: These might be like algae.

DR. HELDRETH: Right.

DR. BELSITO: Red, brown.

DR. LIEBLER: Yeah. But I mean, we have -- it sounds like we may have a significant enough repertoire of synthetically produced silica ingredients that might constitute a report on their own, for which -- well, we'll at least have the data on method of manufacture and composition and --

DR. BELSITO: Particle size.

DR. LIEBLER: Particle size. We won't set aside the issue of is the particle size a posed risk or not, because it sounds like that might be one that's going to be hard to definitively determine. But then we will separate out the synthetically produced materials, which have certainly greater certainty about their composition and impurities --

DR. BELSITO: Well, if we could separate those out, or basically take the silica and silicates and anything that you think is actually related, could we not come to a conclusion even in the absence of our data request for aerosolized, just as we do with sensitization, since we know that some of them are down to respirable range, and some are well above respirable range.

DR. LIEBLER: Right.

DR. BELSITO: Something to the essence that, you know, should be formulated not to be respirable.

DR. LIEBLER: Respirable, yeah. I think we may have to do that, because the one other thing that those distribution figures show us is that there's a great variety. There's, you know, ten-fold variations in the median

Synthetic Amorphous Silica and Hydrated Silica – Expert Panel for Cosmetic Ingredient Safety Meeting Transcripts

particle size, and the low-end tail is going to be dramatically different for the respirable fraction, between these different particles. And that's before you even put it into a cosmetic product with other stuff in it.

DR. HELDRETH: So that would constitute a new type of conclusion for the CIR Expert Panel to say, "when non-respirable." Comparatively, though, other types of conclusions that the panel has come to often look more towards to the product itself. So maybe we don't have enough information to say anything about an aerosolized product, or a spray product, or a powder product.

And so it may be easier for a formulator to read the conclusion of the panel if we're saying we don't have enough information and say it's safe --

DR. LIEBLER: So the data were insufficient to support the safety in sprays or products in which these ingredients may be respirable? Or sprays and -- powders and sprays. They're all powders and sprays.

DR. HELDRETH: Sprays or loose powders or whatever ones you think where the immediate problems.

DR. SNYDER: We don't know that it's insufficient; we know if it's less than 10, they're respirable, and certainly a hazard if you inhale these.

DR. BELSITO: Right.

DR. HELDRETH: I mean, we just talked about how now we have to write a -- you know, something to explain what we mean by non-sensitized, nonirritating --

DR. SNYDER: I get your point. And it sort of gets to -- both are similar responses to the problem. One requires us to introduce a new type of conclusion that we haven't used before. And the other allows us to use a type of conclusion we've used.

DR. BELSITO: We're told they are used in pumps and sprays. Okay? And I think we're also told that there are some of them out there where even before they go into finished products, they're greater than 100 microns.

DR. SNYDER: Less than.

DR. BELSITO: No.

DR. SNYDER: Oh, greater than.

DR. BELSITO: But there are also others that are greater. And if it's those that are used in pumps and sprays, we're not concerned. If it's the ones that are 10, we are, potentially, right?

DR. LIEBLER: Correct.

DR. BELSITO: So we have data to suggest that some of them can be used. Just as with irritation, we have data that when you take an acid and you neutralize it, it's okay. So if you put salicylic acid at 20 percent, but then you neutralize it down until it's all a salicylate salt, we don't really care. So, you know, "formulated to be non-irritating" is something we came up with, because we realize there are so many variabilities.

So when you're looking at this, you know, I don't think the data are totally insufficient to say that they can't be used in, you know, in a product that could be respirable, you know; because some of them can be, based upon the assumption that -- I mean, if you look at A, B, C, D, E, F, I think you get up to M before you get them dropping down into a respirable range.

So, I mean, there are 12, 13 right there that could easily be used in a product that is a pump or a spray. And then you get M, N, P, Q, R, which could be an issue.

So I would actually feel more comfortable saying that there are silicas, silicates out there that aren't an issue and there are others that could be. And therefore, "when formulated to be non-respirable" is a reasonable conclusion. Because if we say insufficient, you know, then a company that is using these, and they're using one that has a diameter above 100 is, you know, in two years in trouble, right?

DR. LIEBLER: Yeah, no, I mean, I agree. So, doing what you were suggesting, Bart, just floating the idea out there, that would essentially exclude perfectly reasonable products -- or perfectly reasonable ingredients for use in pumps and sprays. And really, what we need to do is in pumps and sprays, or other potentially respirable products, is reduce the respirable particles as ingredients.

So, just because we haven't ever done that conclusion before, doesn't mean we can't. There's a point at which we hadn't done formulated to be non-sensitizing, and we did it for the first time. So --

DR. SNYDER: My preference would be that we get some data, because we can have an old report that states these are all safe, even in sprays, because they're a particle size not respirable.

DR. BELSITO: But now we have data that shows --

DR. SNYDER: But now we have new data, so that's all a wash. That goes away. But what we don't have is we don't have the distribution, those tails and whatever it is, because there's no doubt that even a small amount of this material in the lungs is going to cause fibrosis and an adverse reaction.

So even though we have this distribution data, we don't have what -- those tails. You know, even in the products, how much is that? Is that one percent, five percent, ten percent?

And so I think what we need to have is we need to have very specific composition data on all the ingredients that are used in the spray and aerosolized products, period. And we cannot make any determination of safety unless we have that. And so --

DR. BELSITO: Even if we put the caveat "when formulated to be non-respirable"?

DR. SNYDER: I know what Ron is going to say. He says, why don't we just write a simple conclusion, when nontoxic, non-respirable, non-sensitizing. And so I think we can do a better job than that.

I think that if we're evaluating -- our standard has always been that we evaluate ingredients as used. And so we look at those that are used in aerosols, and say, okay, yes or no? Do we have the data? And if the data is insufficient, because we don't know what that tail is, as far as how many particles are less than 10 microns and are respirable, then we can just simply state that, and leave it at that. I'd like to get away from these bastardized conclusions.

DR. BELSITO: So let's say that we get a report and the individual ingredient has a tail where, as a toxicologist, you're concerned about even the small amounts that would be respirable. But now when you put ingredient X into that formulation of hairsprays with PVP copolymer, or whatever else is in the spray, you now get a molecule with none of those tails.

DR. SNYDER: But they've got to give us the data then, in that formulation. I mean, I really need -- we have some to be science-based, data-based.

DR. BELSITO: I understand.

DR. SNYDER: Because it actually would be better for us to say that, in this instance, using this product, an aerosol, is unsafe, because there's a significant amount that's less than 10 microns and is respirable. I think that's a better conclusion --

DR. BELSITO: But how do we know that -- what in formulation?

DR. SNYDER: We have to have --

DR. BELSITO: We just know that from the ingredient. Just like we know that --

DR. SNYDER: Let's say we do the same thing with sensitization, we wanted concentrations in use, so we want to see it with --

DR. BELSITO: Sometimes we say that is a sensitization hazard. And it really depends what product type. This is getting back to QRA. You can't just go by an HRIPT.

DR. SNYDER: I think we're getting a little ahead of the game here, because I think we've got to reopen this old report because clearly what it states as a conclusion is wrong.

DR. BELSITO: Right.

DR. SNYDER: Okay? Because it says all product is not respirable because of particle size, use that as the bar; and that's not the case now, because we know that they can be respirable.

DR. BELSITO: Right. Okay.

DR. SNYDER: So now let's go back and let's just reiterate that for aerosol use, we've got to have some of this data.

DR. BELSITO: Okay. But then we're reopening -- I can't keep straight where we are. But we reopened, we added a bunch of stuff, right? Along with the reopening. Okay. So for silica and silicates, you're saying we need to know particle size for those that are in pumps and sprays.

DR. SNYDER: I think it goes beyond -- you had some other -- composition use, right, for --

DR. BELSITO: Can we go back? I mean, are we going to split this document into natural and synthetic? And do two separate reports? I think that's -- you know, again, that's addressing Women's Voices for the Earth, their last point.

DR. LIEBLER: I think we might as well do that. I think it would help us deal with the issue -- it will help us deal with the issues of impurities and defining the compositions and particle size, or at least control knowledge of the particle size.

DR. SNYDER: It goes to our premise that we always consider the chemistry and uses to group things. And it would make more sense that the chemistry is probably different in a synthetic versus a natural.

DR. LIEBLER: Right.

DR. SNYDER: With composition of things. Right?

DR. BELSITO: Okay.

DR. SNYDER: So I think that makes sense to me initially. But I'm not at that level of a chemist and look at this huge range of things, this list, and know is that -- or is there other appropriate subclassifications? Because I mean, he said there's synthetic amorphous, synthetic silica aluminides, the crystalline, and then the naturally occurring. So some of it --

DR. LIEBLER: This memo from the CSSC basically says don't group things that don't belong together. But they don't say what belongs together. Thank you very much.

DR. LORETZ: I think was it was the clays, the zeolites, the amorphous and silica, and then kind of another category. But it was really that kind of concern that you're kind of talking here, because each has its own kind of questions. It was kind of trying get at that, that there was just too much in one place, and sorting it out was really challenging. So I mean, that's why we were in favor of separating --

DR. BELSITO: So do you think that the idea of separating the synthetics from the non-synthetics is a good start? Or are we going to get a lot of pushback on that too?

DR. LORETZ: Well, I just mean, I think the clays, the zeolites, I think there was a sense that those should be separated within that. Then you need to separate naturals from -- I'm not sure. We hadn't discussed that. But I think those categories would be a starting point where you would separate that.

DR. LIEBLER: Yeah, I mean, it's hard for us non-silica types to even have a hint that you would separate the clays and the zeolites until somebody said, "What do you mean you're not separating the clays and zeolites?"

DR. BELSITO: So, basically, what we're talking about is taking silica and silicates and moving them into a separate report.

DR. LIEBLER: Sounds like it.

DR. BELSITO: And then that would leave us with --

DR. LIEBLER: Still a lot of other stuff.

DR. BELSITO: -- zeolite, attapulgite, bentonite, Fuller's Earth, gold zeolite, hectorite, kaolin.

DR. LIEBLER: Bentonite. Did you mention that?

DR. BELSITO: I mentioned bentonite. Montmorillonite, pyrophyllite, zeolite. The zeolite in general. And so we'd basically be just staying with silicates, metasilicates.

DR. LIEBLER: Hydrated silica and silica --

DR. BELSITO: Yeah, just that. And then what do we do? Do we separate zeolite from clay from Fuller's Earth from bentonite from attapulgite? Or do we try and look at those in one chunk?

DR. LIEBLER: I think our suggestion is that we probably look at those in one chunk, unless industry returns to us with additional reasons to unchunk them further. And they need to be good reasons. Because by making this division, I think we hopefully address the issue.

DR. BELSITO: Okay. So basically, if I'm hearing things correctly, the silicates, silica, metasilicate are going to be separated out. We're going to do a separate report. But we're still with an insufficient conclusion for all the reasons we asked for before, for this entire group.

DR. LIEBLER: Mm-hmm.

DR. BELSITO: And then the remaining naturals, although I'm not sure that the zeolite --

DR. LORETZ: I think that can be synthetic or mined.

DR. BELSITO: Okay. So we'll figure it out. We'll put it in the group for now, and see what happens in that other group that is not silica or silicate, and that will go out as insufficient for method of manufacture, impurities, particle

size; basically what we're asking for the silicates, except we're also going to be asking for a method of manufacture and impurities, which we --

DR. SNYDER: With an emphasis on particle size distribution for the aerosolized products.

DR. BELSITO: Right. If there are aerosolized products in those groups.

DR. SNYDER: Or powdered.

DR. LIEBLER: I'd like to come back to the issue of aerosolized particles and data, to address Paul's very strong concerns here. Those particle size distributions we got would actually allow you to calculate the fraction that is below any size threshold you want to calculate.

So it would be possible for a supplier of an ingredient to perform that analysis and provide that as part of their lot characterization to the manufacturer of cosmetic products, so that they would be able to assess the median and then the fraction below wherever we want to designate as a respirable threshold.

Then someone still needs to decide what's the limit of the amount of particles that are respirable in the product. Now, that's probably not our call, because that turns out to be a specific number. Unless we have data that says, oh, it needs to be less than X parts per million, or Y femtograms or micrograms or whatever. I don't know if we'll ever have the data to allow us to do that. But those data coming from the manufacturer to -- the supplier to the manufacturer of the cosmetic ingredient would allow them to assess the amount of respirable particle that they're incorporating into their product.

And even though we don't say, you know, here's a cutoff number, we say that information should be considered. And I would think that's one of the things you would be considering when you're deciding which silica to incorporate into your cosmetic pump spray or hairspray, something like that.

So we provide I think enough guidance, without being forced to say it has to be above or below this number. Does that help from your perspective?

DR. SNYDER: Yeah, I mean, I think --

DR. LIEBLER: And that allows us to still say “when formulated to be non-respirable,” but in the discussion we would explain that that information can be determined; and that an additional consideration would be the effect of the other components of the cosmetic formulation on the final particle size. Because I think we all agree that could change the particle size, but it's impossible for us to say how much it's going to change the particle size, and it's going to depend on what else is in the product.

DR. LORETZ: And also how it's being dispensed.

DR. LIEBLER: And how it's being --

DR. LORETZ: Which can make a big difference.

DR. LIEBLER: So I still like the idea of saying “when formulated to be non-respirable,” but in the discussion explain what information industry can use to document the particle size distributions of their products that they're supplying to cosmetic ingredient producers, and then for the producers to consider in formulating products.

DR. BELSITO: Okay. So what I have is split silica and silicates from all the others, the data need has not changed, and essentially the data need we needed for that was the range of particle sizes for ingredient to be used in hairsprays and powders. So those have to be identified and get the ranges, but still come out with a conclusion formulated to be non-respirable.

Synthetic Amorphous Silica and Hydrated Silica – Expert Panel for Cosmetic Ingredient Safety Meeting Transcripts

Then for all the non-silica silicates, basically, we're asking what we asked before, was chemical characterization, composition, impurities, method of manufacture and source for those ingredients. And then if any of them are in aerosolized products, particle size and --

DR. LIEBLER: Particle size distributions.

DR. BELSITO: Distributions. So basically what we asked for before, except we're splitting the groups. And then we'd be interested in the scientific committee's feedback on the ones that we threw out, whether they can all be grouped or whether we should look at clay and bentonite and attapulgite and zeolite and any of those others separately or as a group of sticky, earthy subjects.

DR. LIEBLER: Correct.

DR. HELDRETH: So for silica and silicates group, I didn't hear you list method of manufacture or composition --

DR. BELSITO: No. Just particle size and materials used in powders and sprays. That's it.

DR. HELDRETH: What about the silica and silicates that are refined from naturally occurring minerals?

DR. SNYDER: That's why we still want to know the method of manufacture, as in the original request.

DR. HELDRETH: Because aluminum calcium sodium silicate is defined as coming from naturally occurring minerals.

DR. BELSITO: Okay.

DR. HELDRETH: The other ones are vague, and you don't know if it's synthetic --

DR. LIEBLER: My original suggestion was the synthetics versus the naturals.

DR. HELDRETH: But we don't know which ones are synthetic.

DR. LIEBLER: Well, we'll have to find out. We know that two of the major use ones are synthetic. And we may need to find out which others -- well, we have to find out which ones are synthetic versus natural. And again, my feeling from a chemistry standpoint is the synthetics, you know what went into it, you know the process, you know that it was pretty well controlled, they understand what they're making to very high degree. And that separates those from the natural that are refined to some extent, but still have contaminants that are uncontrolled and maybe not even well documented.

DR. BELSITO: Okay. So we're going to split the silica from the silicates or the silica/silicates from everything else. The data needs for the silicates are going to be method of manufacture and impurities --

DR. LIEBLER: Particle size.

DR. BELSITO: For all of them essentially. Impurities will become more critical for those that aren't synthetic. Correct?

DR. LIEBLER: Right.

DR. BELSITO: But that's captured by method of manufacture and impurities. And then particle size and materials that are used in powders and sprays. And then, despite that, we probably still say, "formulated to be non-respirable."

DR. LIEBLER: Right.

DR. BELSITO: And then for the others, the bentonite, essentially the same thing.

DR. LIEBLER: Do we want to see one report, then the other, or two reports in parallel at the same time? I'm trying to see if Christine is staring daggers at me.

DR. BELSITO: I think what we have the most information on are the silicates/silica. I'd like to see that one probably come first, then see that goes.

DR. SNYDER: From that old report. I think that's where we have the most data, that old report.

DR. HELDRETH: And doing them sequentially, we give the CIR Science and Support Committee time to evaluate the second group.

DR. BELSITO: Yeah, the second group.

MS. BURNETT: This wouldn't come back at least until September anyway, just due to the meeting scheduling this year. I have no preference.

DR. LIEBLER: Okay. Well, I think one then the other makes sense.

MS. BURNETT: Probably silica first.

DR. LIEBLER: Yeah.

DR. BELSITO: Okay. So then that's what we're doing. So now can we go back to Women's Voices for the Earth letter and decide how we're responding to them?

DR. SNYDER: The 25th? Which one are we looking at first?

DR. BELSITO: April 8th is the date.

DR. LORETZ: There's two. I dated the Wave 3 as today. Their submission came in on the 25th of March.

DR. BELSITO: There are so many handouts here.

DR. LORETZ: I think you had it.

DR. BELSITO: I've got it. So the first is about crystalline and amorphous silica. Crystalline silica is on Prop 65, amorphous is not. How are we addressing that, by saying we're looking at the respiratory issue?

DR. LIEBLER: I think this letter, at least the whole first page and much of the second page, is about the issue of reporting the presence of crystalline silica. And I'm not familiar with how the California Safe Cosmetics database works, but basically, what Ms. Scranton is pointing out is that they're only required on that database to report ingredients that are on the Proposition 65 carcinogen list, which includes crystalline silica but not amorphous silica.

So the products containing amorphous silica aren't on there. And the ones that contain or may contain crystalline silica are. And she then lists on the next page a number of producers and cosmetics companies that have reported presence of crystalline silica in the state's Safe Cosmetics Program database.

Did I paraphrase that correctly?

DR. BELSITO: Yeah.

Synthetic Amorphous Silica and Hydrated Silica – Expert Panel for Cosmetic Ingredient Safety Meeting Transcripts

DR. LIEBLER: Okay. The next issue is particle size, we come back to that; but the presence of crystalline silica is obviously some -- is of concern.

DR. LORETZ: I wish Jay were here. I totally forgot about that issue, because he was the one who looked into it. And I think some of that is in error. So I think we looked at that and didn't agree with what they were saying; that some of those reports, in fact, were not what Women's Voices for the Earth mistakenly thought they were.

DR. LIEBLER: Okay. I mean, when we see this report again -- so I think it probably should be noted at this discussion in the minutes that this was discussed and acknowledged, and that we agreed that there was apparently some -- potentially some conflict between what Ms. Scranton is reporting to us and what the council has determined, and we need to reconcile that for the next look at this report.

DR. BELSITO: Let me clarify. So what she's saying, companies reporting to California that they contain crystalline silica, that may be inaccurate?

DR. LORETZ: I believe so.

DR. BELSITO: I sort of do, too, because I know -- for instance, if a product contains tar, it has to have a carcinogenic label in California. Neutrogena does not sell their T/Gel shampoo in California, because they would have to label it. They do sell T/Sal, which has no tar in it.

So they're one company who won't label for California and just will restrict sale of products in that state. So I'm surprised to see them on the list as a company that would do that, since their practice, at least up until now, has not been to label for Prop 65.

DR. LIEBLER: So let's just hypothetically say that the council is able to resolve this list down to one company that reports this; what do we do then? If there are one or two or five instead of whatever?

DR. BELSITO: Well, it doesn't really matter, because it begs the question as to whether they're using crystalline silica, as opposed to amorphous. And it begs the question as to whether we agree with the State of California that it's carcinogenic.

MR. JURD: California actually does define it also as respirable. It's not just crystalline. They actually go further in defining, in the Prop 65 list, that it is respirable.

DR. BELSITO: Okay.

DR. LIEBLER: Respirable crystalline silica, not just crystalline silica.

MR. JURD: Not just crystalline silica, yes.

DR. LIEBLER: Okay, but not referring to respirable amorphous.

MR. JURD: Not respirable amorphous.

DR. SNYDER: Okay. We have to get some of this clarified. And I think, as Dan said, Jay sounds like he's on it. So we just want to make sure that he reads the minutes of our concern, and addresses the issues, and brings some clarity to that.

DR. LORETZ: Yes. We'll bring that one back, definitely.

MR. JURD: There was discussion this morning at the other panel meeting, also, on the same point. And I think they were mistaken. There was a mention that maybe we're looking at TiO₂ and not --

Synthetic Amorphous Silica and Hydrated Silica – Expert Panel for Cosmetic Ingredient Safety Meeting Transcripts

DR. LORETZ: Yeah. That's exactly what I remember, that it turned out it was actually TiO₂ that they were talking about. But I didn't want to say that because I'm not clear on the details.

MR. JURD: Yeah, I think that's what it was. I'm not clear on the details, but that's what they mentioned maybe in the source --

DR. SNYDER: What's TiO₂?

DR. BELSITO: Titanium dioxide.

DR. SNYDER: Okay.

DR. LIEBLER: Which is really low (inaudible).

DR. HELDRETH: So from the standpoint of this letter, it came in later than the publication of the report, and pretty late to even make it into our Wave 2. Since this is going to come back to the panel, likely in September, this could be incorporated as part of the report package.

DR. LIEBLER: Sure.

DR. HELDRETH: And the panel will have time to fully consider this more. We'll have Council's input on it by then. And I can write to Ms. Scranton letting her know the panel has seen it, they want to evaluate it in full detail, see you in September.

DR. LIEBLER: Next time this is reviewed.

DR. BELSITO: Okay. So there will be no detailed specific response, rather than simply saying, thank you, it's under consideration. The panel will be looking at this as well as other information that we've requested. You can see our discussion and our document online.

DR. HELDRETH: Once the panel reviews it --

DR. BELSITO: Right.

DR. HELDRETH: -- then we'll get back to you again.

DR. BELSITO: Okay. I'm fine with that response. Anything else on silicates? So splitting them, but the data needs remain the same for both groups. And our recommendation is to come back with silica/silicates first, but we're open to trying to tackle all of them at the same meeting as well. If there's some thought that the data will help cross the boundaries, help us out.

Marks' Team Meeting – April 8, 2019

DR. MARKS: Okay. Any other comments about the fatty acids? Next is the silicates, and I'm going to refer to the information we found on our desks this morning as Wave 3. And there's some pretty significant issues. There's a memo from the CIR Science and Support Committee, and then Christina also sent us a memo about silicon silicates. So Tom and Ron, perhaps you first want to read those? And then when you're done reading those, we can open the discussion. Tom and Ron, have you had enough time?

DR. SLAGA: I'm still reading, but you can proceed if you'd like.

DR. MARKS: No, I think that letter is important, so continue to read.

DR. HILL: In the next two minutes I should be done.

Synthetic Amorphous Silica and Hydrated Silica – Expert Panel for Cosmetic Ingredient Safety Meeting Transcripts

DR. MARKS: Sure. So Christina, I think it's going to be interesting. We may need Bart to help clear up the chemistry of all this, but we'll see where we go. So this is a draft tentative amended safety assessment of silica and silicate ingredients. At the December 2018 meeting, the panel issued an insufficient data announcement for the 40 silica and silicate ingredients. The additional data were a range of particle size, particularly in sprays and powder formation.

We have comments about the importance of particles in these communications since this meeting. The chemical characterization, except for silica -- and that's also been a question of what really are the composition of this group of ingredients, and are they really similar enough to group together in method of manufacture for the ingredients? Our team thought that, in December, we could issue a conclusion of formulate to be non-irritating and assess the respiratory concerns at discussion. But since then, we've gotten a letter in Wave 2 from the SASSI, which is the Synthetic Amorphous Silica and Silicate Industry, concerning SAS, which is synthetic amorphous silica, discussing the inhalation and chemistry.

And then today, we've gotten information from the Personal Care Products Science and Safety Support Committee for the CIR concerning the grouping and concerns that these are not structurally related and about the composition in ingredients and, particularly, a number of the ingredients that contain other components like germanium and zirconium and silver. And Ron Hill, you expressed concern about silver in the past.

So they suggest reconsidering a large number of silicate ingredients in this report because the ingredients are not sufficiently related structurally to form a useful ingredient family. And then their comment was the particle size in the finished cosmetic product is not the same as the particle size in ingredients. So the lack of particle size should not lead to an insufficient conclusion. The memo from Christina, date April the 8th, includes the Women's Voice for the Earth letter, and their first point related to confusion about the CA -- I assume that means California -- Safe Cosmetics Database and the manufacturers who have reported the use of crystalline silica. And they recommend --

MS. KOWCZ: We have -- Dr. Marks?

DR. EISENMANN: We have looked at that database over the last --

DR. MARKS: Okay. Let me finish the letter, and then we can address all this. And then the second was the particle size, again, of the ingredients are highly relevant. So I think they were the two main points from the letter. Okay. So it's gotten, perhaps, more complicated since the last meeting. Carol, Alex?

DR. EISENMANN: We looked at that data -- California's database, and we believe the companies are reporting titanium dioxide, not silica. Silica and titanium dioxide both have this non -- the same qualifier. And for some reason, when you search silica, these companies reporting titanium dioxide are coming up. The name silica, if it's seen on a label, means a more synthetic amorphous silica. It's not a crystalline silica. Under the name silica, they're not using crystalline silica, they're using an amorphous silica.

DR. MARKS: And just for general public importance, what is the significance of the difference, in terms of toxicology and safety?

DR. EISENMANN: Crystalline silica, when it's taken up by -- as I understand it, when it's taken up by macrophages, it causes them to burst and then results in adverse lung effects which leads to cancer. Whereas, synthetic amorphous silica can be cleared from the lungs without causing any additional problems.

DR. MARKS: Okay. Good. That's the way I interpret it, but I wanted to hear it from you. Okay. So I think that addresses the California issue with the Women's Voice of the Earth point.

DR. HILL: Can I just ask a follow up clarification question? So what she's saying in here, if I understand correctly, is that there are companies that make lots of silica containing compounds, but they are only selectively reporting. And what she's asserting is that, presumably, because of the requirements of Proposition 5 -- or excuse me, 65, which would relate to carcinogenic potential, that they're reporting specific ones because they have something in there of concern. So what you're saying is the products that they're reporting all, without exception,

seem to have titanium dioxide and that the labeling -- or the reporting is based on that and not silica. And you can't tell from the way the database is constructed?

DR. EISENMANN: Correct. When we looked at the database, we could only find that they were reporting titanium dioxide and not silica. Because the silica they're using -- if they're using the name silica, it's synthetic amorphous silica.

DR. HILL: Okay. And then the other question I had in this document is related to what she's addressing on the last page, which is the jet milled powder issue. But then it finishes off with powder presses. And so then I thought what in the cosmetic or personal care product would they be using powder press -- to press jet milled powder, except that this is an article in the cosmetics and toiletries news -- some news publication from 2012.

So that concerns me because if there are jet milled powders that are being included in powdered products, that could be potentially inhaled with those particle sizes -- and I have a lack of clarity in terms of what those particles are like and whether they present the same issues as crystalline silica. I'm guessing not because it would then be crystalline product, which would be more along the lines of nuisance dust; but it would sure be nice to have confirmation of that.

In terms of your letter about the ingredient grouping, you're preaching to a member of the proverbial choir because I would like the ingredient groupings -- I understand the convenience of administratively grouping them, but I think it occludes and obfuscates the ability to see clearly the issues that are there. And I just don't understand -- other than administrative convenience and some similarity in the elements that are in there -- why you would group clays with a synthetic amorphous silica.

I would break out the different clays even, or at least make sure that they're very clear in the subcategories. But I didn't have any problem with that because we already had a clay report a few years back, and I was fine with all of that. But putting it together with silica just didn't sit well with me.

DR. EISENMANN: And if you don't separate in different reports, at least within the report, it'd be helpful to have them separate, rather than one paragraph that has silica and clay in one sentence. And then the next sentence is -- and you don't know which -- do you support which ingredient.

DR. HILL: Within the body of the report, you can segregate the information, and that's fine. But then the problem comes when you get cumbersome conclusions where you have to split out conclusions based on large differences in the ingredients. And I think when you have ingredients that don't belong together based on how you would arrive at the conclusion -- and maybe I'm not thinking thoroughly through this enough -- then, to me, that's a good enough reason to split them out. But that's just my take on this, in reading all the information here.

DR. MARKS: So Ron, you would reconsider the numbers and split it out. Tom, how do you feel about that, too?

DR. SLAGA: There's no doubt that they have a good point, and the groupings are different. As Ron said, the elements are the same, but there is structural difference. Are we saying, now, to have these two groups within one report? Because I think we can come up with the same conclusion, can't we?

DR. MARKS: I would think so. The last time -- and again, Ron Hill, you probably have the exception. Our team was actually ready to move on and say safe when formulated to be non-irritating but address the respiratory concerns in a discussion, as I recall in the minutes. In the last meeting, the Belsito team really had the concerns about the inhalation, and that's why the insufficient.

So I guess one way to address the different ingredients is to acknowledge that they're structurally different through the groupings. And the two groupings you're talking about now -- you said silicas and clays. Is that what we mean in terms of the chemical groupings? Because Bart -- I'm sure Christina was the one who put this all together. I wish Bart was here so he could -- but maybe, Monice, you could comment.

DR. HILL: Well, let me just dispute what you said about the elements are the same because, in silica, there is silicon. There is oxygen, nothing else. But the clays typically have iron, other elements that are in there besides silicon and oxygen and nothing else.

DR. MARKS: Is that where the zirconium, the silver and all that --

DR. HILL: Yeah. So then you get other metals. And the ones I raised, I wasn't necessarily sure that there was any problem, but we were lacking data to cross read to the things that are more exceptional, like silver and gold, germanium -- there was one other -- zirconium.

DR. MARKS: Yeah. Zirconium was mentioned.

DR. HILL: I wasn't as concerned about zirconium because I think that's fairly pervasively occurring in some kinds of clays and such. But I think, when you get into some of these ones that have -- they're higher atomic weight and have different redox properties than some of the other elements, then that's different.

DR. MARKS: And then, to be consistent, when we say silica, we're talking about synthetic amorphous silica. Yeah. And that'll have to be very clear in the document that that's what we're talking about.

DR. HILL: And that was interesting because the 2004 SIDs that's referenced includes synthetic amorphous silica but also silicic acid, which again, is oxygen and silica, calcium salt. So there is calcium besides the oxygen and silica, and salicylic acid, aluminum and sodium salt, that's also apparently in that same report. I'm not sure why they grouped that in there, as well, but there must have been a reason. I didn't go back and research that because it didn't jump out in my mind until this.

DR. EISENMANN: They considered the solubilities similar. That's low water solubility is why they can group them together.

DR. HILL: I see.

DR. MARKS: Monice?

MS. FIUME: First, I'd just like to respond to one of the paragraphs in the comments that were received today regarding groupings. Yes, often when we group ingredients, it is for read across, but that is not the only reason that we create groupings.

If a family seems to belong together for several different reasons, they can go into a report. When we do our botanicals, they're grouped because they're all the same genus species, but they don't necessarily support each other. So I did want to clarify that read across is not the only reason to group ingredients. But I do understand the concerns about these being different.

In the past, Christina can definitely go through and break out the clays versus the silicates to make it easier for you to read. We've done this several times in the past, especially when the information in the report is leading to a similar conclusion. If the conclusion is going to be safe for all of the ingredients, we can explain that in the discussion how the different aspects in the report came to the same conclusion, even though what we're looking at might not chemically be specifically the same.

Dr. Hill, I know you said you don't have a problem with the zirconium, but the zirconium being raised -- that ingredient was reviewed before. So somehow or another, it has to be addressed because this is a rereview of a report that had the zirconium ingredient in that 2003 report. So that can't really come out. It has to be addressed, but we definitely can break down the groupings.

We can have a mixed conclusion if some of the ingredients that are in there are not considered safe, but the others are. We've done mixed conclusions. And we have done reports where we have split them by different families and

brought you all the information, and then bring it all back together in the discussion as to how the conclusions were reached.

DR. HILL: But we've also split out into separate reports when we thought there was good reason to do that, and I don't really understand what the big difficulty is with creating three different reports, as opposed to trying to get everything properly grouped within one report. And when I came on the panel, the idea behind groupings was that we would be using that for read across; and they should be no brainer read acrosses or we wouldn't put them together in one report. So we've certainly departed from that quite a way.

Botanicals are different. I don't think we should even think about botanicals in the same way as we think about other classes of agents, such as silicas, such as polymers, such as like that. Even some of the polymer groupings have been very cumbersome in terms of putting them together all in one report, but at least -- I think, from a physicochemical properties point of view, it makes sense.

So I mean, it's not up to me. But if it were up to me, there would be probably two, and maybe three, separate reports here. And I realize we may leave some strays that have, again, silver, gold -- some of these other elements well and good. If they're not in use, then strays are just strays. If they are in use or we've reviewed them before, like zirconium -- which I think was one of the reasons it was sticking out in my mind, and you just put words to it. No problem there. But to me, that would group with clays and not with silica.

MS. FIUME: Again, it's always a prerogative of the panel. That's why we bring the rereview groupings to you to be approved. With the rereview, you do have the option to change your mind. But having the whole panel weigh in on it would be great. And as I said, we have done it where it's separate reports; but generally, in the past, we've broken them out into different groupings by different families and kept it within the same document.

DR. SLAGA: So we're going to table it until --

DR. HILL: We're not deciding anything today.

DR. MARKS: Let's -- before we get to what I will move tomorrow, I just want to clarify. I've heard two groups and I've heard three groups. So again, we'll need direction for Christina what our team feels. So Ron, you said two or three? I initially heard the two groups being silica, which is synthetic amorphous silica, and then clays. Is there another one you would put in there, besides those two?

DR. HILL: If we were going to split our reports, then a starting point for me would probably be -- although, I have to revisit this -- would probably be silica, and we could decide if there are a couple of others -- again, if it's just silica and oxygen, we can put silicic acid -- those things in there. I think calcium soluble silica still should be fine, but that and everything else -- if we're going to keep them in the same report, then I don't think groupings -- they're major groupings.

And we can decide, then, how within the report to group. But the fundamental issue is, does it all stay in one report, or do we create a separate report? What was in the silica report, again? There were two that we reopened. There was one that was silicas.

MS. BURNETT: The original silica report contained silica, alumina magnesium metasilicate, aluminum calcium sodium silicate, aluminum iron silicates, hydrated silica, and sodium potassium aluminum silicate.

DR. HILL: All right. And so the question would be those ones -- for example, the one with the iron in it, does that stay there or go with the clays? I'm not willing to make an off the cuff comment on that one without looking again.

DR. MARKS: Okay. Carol, Alex, how do you like the idea of having the same report and just groupings within it? I mean, we've done that, not just with the botanicals. I think we've done that with other groups of ingredients. Do you see a problem from your point of view?

MS. KOWCZ: I think the one thing that we are trying to address with Monice is, if we are going to have one report, then we do have to have specific delineations or differentiations of this chemical class versus that chemical class, because it is different based on the physical chemical properties, as Ron has stated as well.

So if we can do that with a mixed conclusion, as you've said you've done in the past, we just feel that they're very different materials and that they should not be all grouped together. But if that's an opportunity to do it in one report, with different conclusions and really showing that the data goes to which group, I think we'd be fine with that.

MS. FIUME: And I guess the reason I was pushing for the one report with the subgroupings, is because that 2003 report that initiated the rereview does have a mix. For example, kaolin is in that 2003 report, as well as the silicates. So it is very mixed.

So it seems, in order to take that rereview forward of that report -- if we could create subgroupings in this rereview document and, therefore, address the ingredients that were looked at in 2003, that would keep the family from the 2003 report in the same rereview, but also explain the different groupings that were included originally and how they're being looked at now.

DR. HILL: So if it were up to me -- if I ran the zoo, we would create new reports. And one would be silicas, and one would be clays, and one would be zeolite and maybe a diatomaceous earth; and one would be other things, that aren't silica, that aren't clay, that aren't zeolite, that aren't diatomaceous earth.

And I'm thinking, in terms of zeolite and how I know those are used industrially, I think it's interesting they end up in cosmetic ingredients. So we would have strays, but I'm pretty sure I would create four reports, maybe five, if I ran the zoo. And I don't. And they would be new reports, and then that would give the opportunity -- because I think there are still some issues out there in the wind, no pun intended, but maybe about aerosol sprays, for example.

Because again, I think we're still missing -- and we identified them as we were trying to put to bed the aerosol report, which I still don't think we've ever -- our guidance document -- I don't think we've finalized that, have we? And promulgated it. But there were some pieces of issue out there, such as if you have an aerosol spray and then the solvent evaporates as they're flying through the air, and you start with the glomerates, depending on what the substance is in there -- what happens between there and it gets to my nose?

So it would provide a little bit of time, as well, to make sure we've revisited each of those as relates to the specific categories of ingredients. Because when you're mixing things like the flow chart -- that's very nice that they gave us. It's fairly near the end of the PDF here that was from the SASSI -- shows with the synthetic amorphous silica and how that relates to the others that are silicates. And there's nothing else in there by silicon.

Those things all grouped together -- and then you could add, again, things that are only silica and oxygen, maybe a calcium salt, and then decide from there do we include aluminum-containing compounds or does that go in a different report. But I'm just looking at, if the issues are necessarily the same, can you discuss them all in the same report? I'm sure you can find a way to do that.

But having to keep the same ingredients together in a rereview, to me, seems to be artificial. There's no good scientific logic. I wasn't around when the 2003 report was put together and the grouping was established, so I don't know why I should be stuck with it, I guess, is one way of saying it.

MS. KOWCZ: Would it be difficult to separate them now with the 2003 report already established?

MS. FIUME: It can be done, and we've had ingredients that have been pulled out. I can't speak to any of the chemistry as to why Bart put this together. So I would really rather let Bart comment on his feelings on keeping them in one report versus separate, because he builds the documents based on his chemical knowledge. So I would prefer to let him comment on it, if that's okay.

DR. MARKS: Sure. Tom, what's your feeling about this? You proposed tabling it, but I'd like to get back to the discussion. Perhaps, we know where Ron Hill stands with having multiple reports. You had previously -- and I'm certainly fine with having one report. We do many reports where we have split conclusions. So I think Bart's input is going to be very important.

I kind of like the idea of tabling it because I think we've gotten enough new information. In terms of particularly handling the structure, I don't know how we can move forward with a tentative amended report if we don't have it clarified as far as what are we going to do with these different structurally chemically different ingredients and how we're going to group them.

And I actually kind of liked, Ron Hill, your approach. You have the silica, you have the clays, and then you could have an "other" group or a "miscellaneous" group, and still have it all in the same report. I guess then it'd be up to Bart to name what that miscellaneous new report would be.

Whereas -- would the title of this still be silica and silicate ingredients, or would it be silica and clay ingredients? Or would the title change now since we're -- so that's another thing to think about, because it doesn't sound like silica and silicate ingredients really cover these structurally different ingredients.

DR. HILL: And honestly, when I read the SASSI -- the most recent input, I thought, okay, they have some things in process currently, as well, related to all of this. And that if we were able to table and have just a little bit of space and time to think about how better -- it could come back as quickly as June, perhaps, if we get information from the industry group. But I was around for 2008 when we got that first -- I was here in 2009 when we were still looking at the SASSI input data, and I remember we had at least one of those individuals from that organization come and give us a presentation, if I'm not mistaken.

So I just felt like my take on reading that was could we table this and have a look at those issues seriously; discuss with the industry groups, and decide what this should look like in the end? And the other thing I was going to mention while I've got the mic -- and then I'm going to shut up and shut it down -- is there any chance we can get Bart in for this discussion? Can we table for the moment and sometime between now and the end of the afternoon, if we're the ones that have to move tomorrow, get Bart in for some of the discussion? Or do we have that all happen overnight?

DR. MARKS: I feel comfortable moving tomorrow table, and raise the reason that we feel we table it because we had a structural ingredients difference. The issues have been raised by the Science and Support Committee and actually also -- now, I guess it wasn't raised by the Women's Voice of the Earth. They will remain particle size.

DR. HILL: I wanted clarification about this jet milling thing, because I think we're still okay just because it's not crystalline at that point. But I wanted to feel a little better about that.

MS. KOWCZ: Dr. Marks, can we just ask -- we have a representative from SASSI -- because this is the perfect opportunity to ask any questions. And we do have the industry expert.

DR. MARKS: Excellent. So would you please introduce yourself, and you can use SASSI but also tell us what that means -- meaning the full name of it. I know what it is here -- the Synthetic Amorphous Silica and Silicate Industry. But for those of us who may not be within that industry, SASSI doesn't mean a lot. It could have other meanings, if you're sassy.

MR. JURD: Brett Jurd. I am currently the chairperson of SASSI, which is a trade association actually formed in -- about 20 years ago to differentiate synthetic amorphous silica from crystalline silica because it was, at that time, being lumped together.

We are and work with a similar associate that's part of CEFIC in Europe, called ASASP. The organizations have very close memberships. We represent, basically, the eight to ten major synthetic amorphous silica producers

Synthetic Amorphous Silica and Hydrated Silica – Expert Panel for Cosmetic Ingredient Safety Meeting Transcripts

globally. We're missing one or two companies there, but for the most part of -- all the major companies, PQ, PPG, are all members of our association.

We do a number of things, including supporting studies. If you know it or not, there's a lot of activity going on in Europe right now. We would be more than willing to provide whatever support you need to come to the correct conclusion. A lot of our members also are involved in other silicates; you know, manufacturing, the ones that you said were in the initial report.

And we also, for one reason or another, the companies -- and I actually am with W.R. Grace. We actually do mine clays and also put on the market zeolites, although not for cosmetic purposes. But we have chemistry experts, within our organizations, that can help differentiate those kinds of materials.

The one thing we feel very strongly about with synthetic amorphous silica -- and I think the points made earlier about the differentiation between the crystalline form, which is classified as carcinogenic, particularly the respirable, the less than ten-micron particle size, and synthetic, is there's a significant health difference between the crystalline. Even California differentiates crystalline amorphous respirable silica as the carcinogenic version, not just larger particle sizes.

DR. MARKS: I don't know whether you want to -- since you're here and you may add -- we had a rather robust discussion prior to you coming into the room about the structurally different ingredients, which are grouped together in this tentative report. And that was also raised by the association manager in a letter -- that clarification on the scope of the 40 ingredients. And this was authored by David Pavlich?

MR. JURD: Yes.

DR. MARKS: So I guess what our team is struggling with, or discussing, is whether to have one report dividing these ingredients into two or three groups, a silica group, a clay group, and another group, which would be a miscellaneous group of ingredients in the same report, versus having multiple reports. This was also pointed out by the CIR Science and Support Committee of the PCPC. What's your feelings about splitting it out and how you would do that? One might be the report just on silica, which we now -- when I say silica, I refer to synthetic amorphous silica, SAS.

MR. JURD: We would agree. We would like separate reports. Particularly, as was mentioned, I think clays fit into a different class. There can be a lot of contaminants -- other materials in clay, including crystalline silica. So you've got that component that could potentially be in there and could be an inhalation hazard in certain types of formulations in cosmetic products. That's an opinion on my part not supported by any scientific evidence.

I think you would have to look at maybe -- like zeolites, you could do an aluminum silicate or alumina silicate kind of grouping. A synthetic amorphous silica, which I think is the majority of the silica, if not all the silica that's found in cosmetic products, I think is chemical synthesized rather than naturally occurring. And then, as you mentioned, a miscellaneous, because there were some very unusual materials kind of lumped in that category.

And I think if you look at -- at the very high level, it's like where else could they fit? Ah, this makes sense. We can lump them in to here. But if you look at the data that's out there -- and I think you talked a little bit about read across -- I'm not sure if you could do read acrosses at this point in time because I don't think the data is necessarily there to be able to afford that conclusion.

DR. MARKS: Okay. That helps us -- reinforces that we need to have different groups. I think the question will be do these different groups occur in the same report, or do we split it out as different reports? And we'll handle that in the future. So tomorrow, I'm going to move that we table this because of the ingredients that are structurally different, and I'll kind of summarize what we talked about, Tom and Ron. And obviously, feel free to add into that. Any other comments from our --

Synthetic Amorphous Silica and Hydrated Silica – Expert Panel for Cosmetic Ingredient Safety Meeting Transcripts

DR. SADRIEH: I'd like to just mention that, regardless of what's done in the end, I'd like for the issue of magnesium calcium silicate to be addressed, which is asbestos. So that's something that -- whatever conclusion you come to, I think the potential for any kind of asbestos contamination would have to be addressed.

MS. BURNETT: Did you say magnesium calcium silicate is not an ingredient in this report?

DR. SADRIEH: Correct. But you could have contamination. Asbestos contamination is not an ingredient. You're looking at ingredients.

DR. MARKS: Yes. That obviously gets to the impurities portion of these ingredients. So just as we've heard that clays may have crystalline silica as a contaminant in it or a component impurity, so the same way we'd have to deal with asbestos, too. Thanks for bringing up that point. Yes?

MS. BURNETT: Before we move on, in the Wave 2, I asked -- I know there was a lot of data points. How would you like to have that data represented in the report, if at all? It was SASSI provided different particle size readouts for different samples of -- I think some of them were cosmetic products. Some of them were straight.

DR. HILL: Excuse me. It came to my comment about making sure that we revisit our inhalation/aerosols document and where we landed two meetings ago. I think we looked at some of that in December, didn't we?

MS. FIUME: Right, it had not reached finalization yet.

DR. HILL: Because I don't think there's any really new information. They sent us a data dump is what it appeared to be, with some particle size characterizations, which is helpful. But I don't know that there's any new information in there whatsoever. I think where I still have data gaps is -- we had a pretty good summary, and I think a lot of it came in that SASSI report from 2000 -- S-A-S-S-I report from 2008 about the issue of agglomeration in finished cosmetic products.

But once a manufacturer of an ingredient sends it to the formulators, then it's really on the formulators to figure out what happens from there and if I spray it in an aerosol spray -- and now we have different aerosol devices. So that was something else that came to the floor in that last round -- the last rounds of data we had is that, well, there's not just one kind of aerosol can and one kind of pump spray.

There are these other things that we hadn't maybe fully considered. And any given ingredient, I'm not sure we have the full scope of everything, but we're supposed to be getting it and reviewing based on what information we do get, what kinds of devices do we have? Are they for sure larger particulate agglomerations? Because the particle sizes that I gave us are, I think, are the raw ingredient before it ever goes into a product, if I'm not mistaken, in that Wave 2 data dump that we got. So that doesn't really give us the full picture because -- unless that was added to a face powder.

They talked about the feel of these jet milled powders, and that's what got my attention; is what's added and what's actually being sold to the consumer, and what particle sizes are in there. And is there anything crystalline as an impurity is the immediate concern. And beyond that, is it nuisance dust or something else we have to worry about? And we have these inhalation documents. We've got these face powder and loose powder, and then we have some statement about exposures are thus and such related to workplace exposure. And I'm thinking, well, yes, but what's the stuff? If it's just nuisance dust and it's innocuous, and we don't have to worry about anything that might happen -- sensitization in the bronchials, for example, or something like that -- that's one thing.

But there's disconnect every time I read that statement right now. And we talked about that as our -- not boilerplate, that's the wrong -- our guidance document is being updated. That we had these issues that were still out there. I don't know if we could ever actually resolve them because the science keeps improving in terms of what we know. But the other thing that came to the floor is it actually assessing how much of what size of particles come into somebody's breathing zone and what the actual exposure is daggone hard, if not almost totally impossible.

Synthetic Amorphous Silica and Hydrated Silica – Expert Panel for Cosmetic Ingredient Safety Meeting Transcripts

I just know if my wife's using hairspray in the bathroom -- where she hasn't much used aerosol sprays anymore. But if she is, I can't walk in there because I'm going to be coughing for the next ten minutes. That's a sentinel. That's my defense mechanism. I don't worry about any danger to me, but it doesn't take much to trigger that cough reflex. So I know there's particles, and I'm breathing them.

MR. GERMILLION: This is reminding me. There was a discussion at the last meeting, or two meetings ago, about formulas being non-respirable and a decision not to go that route. Am I remembering that --

DR. MARKS: Yeah. That's correct. Ultimately, it turned out to be issuing this insufficient data announcement and asking for the particle size. But you're absolutely right. Our team felt that we could handle the issue with inhalation in the discussion and not put that in the conclusion, but we lit on doing the insufficient data announcement.

Now, we have gotten more data. Obviously, synthetic amorphous silica is not an issue with inhalation. It's not a respiratory toxin. And then we have this memo from the CIR Science and Support Committee. And basically, in referring to particle size, the finished product -- cosmetic product is not the same as the particle size of the ingredients.

So it's the end product which we should be, again, addressing, and that needs to be addressed in the discussion, I think. So the lack of ingredient particle size should not lead to an insufficient data conclusion. I don't know if that answers your question, but you're absolutely right. Actually, that was one of the big discussant points last time. Not so much the structural differences among these different ingredients, which we've lit on in this meeting, but the previous one was really the respiratory issue.

MR. GERMILLION: Yeah. And I remember that back and forth, and then I'm looking at this Women's Voice for the Earth letter. And she starts another reference to particle size and the manufacturer representing particle size at some level.

DR. MARKS: So I think we will address that in this. We're going to have another crack at this, if not multiple cracks at it or reviews. Because if indeed we table it tomorrow -- and that's what our team will move -- then not only will we deal with the issue of structurally different ingredients, whether it's in the same report or multiple reports, but we'll also, I'm sure, go back and address the inhalation toxicity. And for SAS, that does not seem to be an issue. It's going to be these others, perhaps, and particularly the clays where you could have contamination with crystalline silica and asbestos, too, if that's an impurity.

DR. SLAGA: All the data in Wave 2 on particle distribution could be summarized in the report. I don't think we need all -- Ron should be able to help with that.

DR. MARKS: Well, and Ron Shank did.

DR. HILL: And it strikes me in listening to this -- we have language, for example, formulators should take caution not to put a penetration enhancer in the same formula when dermal absorption was our index of safety or lack of dermal absorption was our index of safety.

And I think we need -- and it will probably depend on the exact ingredient and situation -- comparable language here that it shouldn't be formulated to set up this scenario, which potentially sets a risk. And that could probably even include crystalline silica, provided it's in some cream where there's zero chance that it will ever be volatilized versus an aerosol can where perhaps we're not quite sure in some cases.

DR. MARKS: Robust discussion. Any other comments? So Tom and Ron, I'm going to move that we table these ingredients tomorrow. We'll, I'm sure, in the discussion tomorrow decide whether or not we're going to move forward; for the time being, at least it's a single report with split out ingredients within that or multiple reports. And I suspect we will touch on inhalation again, perhaps. Certainly, that'll come up again multiple times. Thank you for your comments.

MR. JURD: No, thank you.

Full Panel Meeting – April 9, 2019

DR. MARKS: So in December's meeting, the panel issued an insufficient data announcement for the 40 silica and silicate ingredients. The needs were listed in Christina's March 15th memo, particle size, chemical characterization, method of manufacturing.

Since that, particularly in Wave 2 data, we received a letter from the Synthetic Amorphous Silica and Silicate Industry (SASSI) concerning synthetic amorphous silica (SAS). And that that wasn't anywhere near the same as crystalline silica, didn't have the toxicity of crystalline silica.

And then also, in Wave 3, as I'll refer to what we received yesterday, was Women's Voices for the Earth letter, and the CIR Science and Support Committee letters, all concerned about the grouping of these different ingredients, and that they were dissimilar.

So, that elicited a significant amount of discussion on our team. We move that these ingredients be tabled and be represented to us. And what we suggested, we weren't sure whether it be three separate reports or in one report. Personally, I was fine with one report. But the groups would be the silica group, which is the synthetic amorphous silica, clays, which may have contamination with crystalline silica, and then other ingredients, such as that contain silver zirconium. And look at these different groups separately.

So our motion is to table it and relook at this once these have been divided up by structural groups.

DR. BERGFELD: Is there a second, or a discussion or a comment?

DR. BELSITO: Well, I don't know if we said table or not, but we agree with splitting the report into silica and silicates from all the others, and then trying to look at all the others separately but start with silica and silicates. And our data needs haven't changed, method of manufacture and impurities, and particle size in materials that are used in powders and sprays.

So I guess if that's a table, then it's a table. But I think of a table as the report just staying as it is, and that's not what we're requesting. We're requesting that it actually be split, for now, into two, that silica/silicates be a separate report addressed first.

DR. BERGFELD: Bart, you want to comment on that?

DR. HELDRETH: Either process is possible for the panel to take. I think if we're not waiting for some new data, or some new information to come in, then it does make sense to proceed and not put it in a table mode where we don't know where it's coming back.

Also, yesterday, I heard from the Belsito team that we would do these sequentially. And do the silica and silicates -- immediately return as a new report in the process, whereas the rest would constitute another report. And this would give us time to focus on the silica and silicates, and also give industry time to take a look at that grouping and let us know their thoughts on those materials.

DR. BERGFELD: So it sounds like this is just an administrative movement that we do not have to go out as insufficient, we don't have to table, but we will take it as a tentative -- a draft amended?

DR. BELSITO: It's still insufficient, though.

DR. BERGFELD: Yeah.

DR. BELSITO: Because we still want method of manufacture, impurities, and particle size for use in powders and sprays. So there are data requests that are there.

DR. BERGFELD: So, do we send this out again, as an insufficient data request?

DR. MARKS: I guess one could send it out as a revised draft tentative amended safety, because that's what we're doing, really revising it, and that would be the next iteration.

Just to go back to particle size, both from the manufacture SASSI, the industry, association of manufacturers, and then also from the Science and Support Committee, they address the particle size. And from the Science and Support Committee, particle size as finished cosmetic products are not the same as a particle size of the ingredients. The lack of ingredient particle size should not lead to an insufficient data conclusion.

So I don't know whether industry wants to address that; but if we send out an insufficient for particle size, I guess we're ignoring what the Science and Support Committee has responded to that request.

DR. BERGFELD: Alex, you want to respond?

DR. BELSITO: I'll let Paul respond, but I mean, I don't think we have to agree with what the committee says. We didn't yesterday.

DR. MARKS: On, no. I agree. I just think we need to rationalize, you know, why we're still saying --

DR. SNYDER: I think we were taking an ultraconservative approach because there is a risk if these are inhaled, because it will cause a hazard. And so we want to fully understand the particle size distribution and have better appreciation for that before we approve. And so I think it's a high-level approach. We'll ask for the data and then once we see their justification for needing or not, then we can make our final conclusion at that appropriate stage.

DR. MARKS: Paul, would it be -- I'm kind of just thinking out aloud here -- would it be similar to the monomers? And when we look at those ingredients, how much free monomer is left? How much free of the small particle size? Because it seems like what we're getting is that these aggregate in the finished product; so therefore, whatever we start as a particle sizes is irrelevant. Unless, to my mind, there are residual small particles, I guess. Is that reasoning correct?

DR. SNYDER: That's correct. And we were assured that once they've aggregated or agglomerated, whatever you refer to it as, that it's nearly impossible for them to dissociate. But again, we don't have the data to know how much of what impurity in regard to any smaller particles that might be in there.

DR. BERGFELD: Carol, do you wish to speak?

DR. EISENMANN: I still think there's a -- synthetic amorphous silica is so different -- and those two, the hydrated silica -- and so different from the others, they can control the composition more carefully, if there is some solubility. It's not an inhalation. If you inhale it, some of it will dissolve and get removed from the lungs, versus other silicates. And I'd hate to see you keep putting those two ingredients, lumping them with the rest, because there is a big difference between them.

DR. BELSITO: And I think we'll probably get a better understanding of that when we separate the silica and silicates out. But it doesn't hurt to ask for now, and we may determine that it's not needed after looking at it.

DR. EISENMANN: And that's the information you've gotten in Wave 2, that they've already provided. And not only that, there's an OECD summary, that the data is in the report, but within the report that hasn't come to the CIR

Synthetic Amorphous Silica and Hydrated Silica – Expert Panel for Cosmetic Ingredient Safety Meeting Transcripts

report yet, particle size and surface area is listed for a lot of the ingredients, that the data is in, that still has to be added. So you have a lot of that already for SAS and the hydrated silica.

DR. BELSITO: Yeah, and we'll look at it. But I mean, I don't think we're prepared to withdraw our recommendations at this point for additional data needs. Again, when we look at it, we may determine that we really didn't need these, as we often do.

DR. BERGFELD: I'm going to ask Bart to respond, because administratively we can handle this a number of ways. So will you elucidate those or just explain the possibilities?

DR. HELDRETH: Sure. I think that the possibility that seems most in line with the consensus that I'm hearing is that we will bring back, at a future meeting, this draft tentative report, which will be revised. It won't be a new report that's going to go out for public comment.

The silica and silicates draft tentative report will come back to the panel, and then there will be opportunity for the panel to address the new report and the comment period will open thereafter.

DR. BERGFELD: So everyone understands, we -- just a minute, Ron -- we will not be voting on this. It's a consensus opinion, that it will go back to the staff, divided up separate items -- or ingredient groupings -- and then come back to us again for discussion and vote. Ron Hill.

DR. HILL: Actually, was not my concern that was discussed yesterday. But we asked about the implications of removing ingredients, given that this started as a re-review or reopen. And that's where we came and said, well, does this need to be then a new report, or a series of new reports, number to be determined.

And I was only asking that question, because I was sitting here pondering what if the report that comes back is that we only look at synthetic amorphous silica, which as we understand it, that's the only silica that should be used in cosmetic products at this point; and then everything else, where we could keep silicates in with clays and so forth, because some of the issues in terms of safety would be the same.

And I just, I don't know if that's an option or not. How far can you cut down before it's not a new report, I guess is what I'm driving at.

DR. HELDRETH: I don't think anything is going to be left out here. All those ingredients that we've looked at before are going to get reviewed. We're just reorganizing the format.

DR. HILL: But into one report, or are we breaking out into separate reports? Because that's what matters, I think, in terms of technicality of procedures.

DR. BERGFELD: It's my understanding that they'll first break it out into the different categories that we've explained. And then the next meeting, we will decide how we're going to handle them.

DR. HILL: Okay, I wasn't clear on that, but got it.

DR. BERGFELD: Okay. Dan?

DR. LIEBLER: I want to clarify that the breakdown needs to include all the synthetics together. So, I don't know if the synthetics are limited to hydrated silica and silica, or if there are any other ingredients on our current list that are the synthetics.

But those are the ones where the composition and structure can be exclusively controlled. Many of our issues with possible contamination with crystalline silica, or other things, that is already handled in the production of those.

So I just want to make sure that the grouping, the reorganization, puts those synthetics together, and doesn't contaminate them, so to speak, with the mined or other silicas.

DR. HELDRETH: So then, to that point, which ingredients are those?

DR. LIEBLER: That is my question. And there's somebody here who knows, and it's not me.

DR. HILL: We got, at least -- and you weren't in this group yesterday -- Brett, from the SASSI, who also clearly has expertise in many of these other areas and was aware that crystalline silica as an impurity in mined powders could be a problem. Whereas synthetic, you're exactly right, when they can control what's there, then those issues should go away.

But then the question will be, I still think the silica grouping, whatever it is, should at least be restricted to things that have silicon, oxygen, and maybe salts, thereof, calcium, aluminum, like that.

DR. HELDRETH: I don't disagree with that. But unfortunately, we don't know which ones are synthetic and which ones are not. For example, some of the salts that are listed in Table 1 would seem to be something that could be made synthetically, but the definition says that they are mined.

DR. HILL: Yeah.

DR. HELDRETH: And the other ones, it's unclear of the source, or whether it's --

DR. HILL: So that's an insufficiency, really.

DR. BERGFELD: Well, I think that we can proceed and perhaps have some consultation with the CIR SSC committee and see if we can figure this out.

DR. SADRIEH: I just wanted to mention that, you know, yesterday you brought up the issue of potentially evaluating as a contaminant, asbestos, which is magnesium calcium silicate. And so, I just wanted to make sure that, for the record, that it was mentioned right now.

DR. BERGFELD: Thank you. All right, I think we will move on then. Administratively we're taking this back, reorganizing it, and bringing it forth again, in the next meeting or so.

JUNE 2019 PANEL MEETING – 2nd DRAFT TENTATIVE AMENDED REPORT

Belsito's Team Meeting – June 6, 2019

DR. BELSITO: Okay. Silicates. So, at the 2009 team meeting, we tabled the report that contained 40 ingredients for the CIR staff to reorganize it and to get rid of those that are mined and to look at just those that are -- I just went blank on the --

DR. LIEBLER: Synthetic.

DR. BELSITO: Amorphous synthetics. So we're getting this back to us and we've gotten comments from SASSI and from Women's Voices for the Earth.

DR. LIEBLER: And we got that email forwarded from the California --

DR. BELSITO: California. Right. Well, that came via Women's Voices for the Earth. Did it not?

DR. LIEBLER: Yeah. Wasn't there a separate email that Bart sent to us?

DR. BELSITO: Yeah.

MS. FIUME: There was a separate email.

DR. BELSITO: Yeah. It was sent on June 3rd at 7:54 a.m. Oh, I guess Bart looked this up in response to the WVE statement. Is that --

MS. FIUME: No, we received an email from Paula Johnson, who is in the California Department of Public Health.

DR. BELSITO: Okay. So, they would require it to be labeled the crystalline, which is not what we're looking at. And I guess I had the same comment for Women's Voices for the Earth concern. As I gather it, were not really concerned about the amorphous synthetics. Is that correct?

DR. LIEBLER: Right. I think that the problem is, both in this email from Paula Johnson and in the letter from Alexandra Scranton, Women's Voices for the Earth, is the possibility that crystalline silica is used in cosmetic products. In our report, we re-formulated our report to focus on synthetic amorphous silica and silicates, which excludes crystalline silica because of the manufacturing process which does not produce crystalline silica. So that's what we're reviewing.

And then the question is, of the reported products and usages for silica, there appears to be some ambiguity based on Paula's email and screenshot which represents ingredients in their reporting system. This is echoed in Alexandra's letter to us.

And I don't understand why the ambiguity, but I would note from the email from Paula Johnson in her second paragraph, she says, "Our reportable ingredients list posted on our website lists crystalline silica, and our reporting system menu of ingredient options contains crystalline silica. Companies are not required to report amorphous silica and it is not an option in our reporting system menu. As you can see from the screenshot of our public search site, there are currently 1200 products reported as containing silica, crystalline (airborne particles of respirable size)." These are reported by 35 different companies whose identities are also available by the public search site.

So, it's possible that these companies are reporting the use of crystalline silica as specified. It's also possible that because there's no menu option for selecting synthetic amorphous silica, they're using crystalline silica as a default, perhaps unaware of the problem that this creates in characterizing materials that we're reviewing. And I have no way of knowing which of those things are true and to what extent it's true.

DR. BELSITO: But at the end of the day, we're not reviewing --

DR. LIEBLER: Right. We're not reviewing it. I think they're raising an issue that we have no control over, except to the extent in our report to say that there is insufficient data to support crystalline silica.

DR. BELSITO: We're not even looking at crystalline silica. It's a separate report.

DR. LIEBLER: So, we're not reviewing it.

DR. BELSITO: We decided to split them.

DR. SNYDER: That's what the SASSI data also considered. As he reads the report, it's still confusing as to what we're actually reviewing. At the top of that second page on his --

DR. BELSITO: Right. Yeah, yeah. But I think we just need to make it very clear up front that we specifically are not reviewing that. I thought we did do a decent job with that, but I guess we didn't.

DR. EISENMANN: I still have four ingredients at least that I think should come out based on their definitions. There are three ingredients defined as ceramic powders. Even though they're synthetic, I'm not sure ceramic -- I don't think you can say a ceramic powder may not have crystalline silica in it.

DR. LIEBLER: Which ones are those, Carol?

DR. EISENMANN: Which ones are those? They are --

DR. BELSITO: PDF page, Carol?

DR. LIEBLER: This would be 118. The initial ingredient list is PDF 118.

DR. EISENMANN: Aluminum Iron Calcium Magnesium Germanium Silicates is one. Aluminum Iron Calcium Magnesium Zirconium Silicates is the second.

DR. LIEBLER: Okay, the second one. Yeah.

DR. EISENMANN: Aluminum Iron Silicates is the third. In the definition, they're defined as ceramic powders. I think when you heat up clay and then crush it, you probably have the potential -- and we don't have any information on the ingredients.

DR. LIEBLER: That's three. You said four.

DR. EISENMANN: Right. The fourth is defined as a zeolite. It doesn't have zeolite in the name, but Ammonium Silver Zinc Aluminum Silicate. The definition says it's made with zeolite, and all the other zeolites have been moved.

MS. KOWCZ: And if there is any further clarification needed, we have representatives from SASSI here with us today. If there's anything else that you --

DR. LIEBLER: Are they in another room?

MS. KOWCZ: They're right here.

DR. LIEBLER: Oh.

MR. JURD: We are.

DR. LIEBLER: Oh, good. Okay.

MR. JURD: Do you want us to come up?

DR. LIEBLER: Yeah. Could you come up and use the microphone?

MR. JURD: Absolutely.

DR. LIEBLER: And if you can speak to the specific issue we were talking about with the last four ingredients, if you can, that would be helpful. And then to the larger issue about what we're reviewing. So, first of all, these four ingredients that Carol just mentioned, are these on your radar as crystalline imposters?

MR. MICHOS: Well, these materials are not pure silica. We have no idea how the aluminum or the germanium and all of the other elements are incorporated, how labile they are. So, we have no idea, no saying; we have no grounds for standing up here and telling you if this is safe or not.

DR. LIEBLER: So these couldn't be defined as synthetic amorphous silica?

MR. MICHOS: Silica does not include all the other elements that are present in the name of the material. So they're not silicas.

MR. JURD: They're silicates. So, they've got aluminum and other metals in there.

DR. LIEBLER: So, based on their composition and/or methods of production, they just don't belong in this report?

MR. JURD: That is our opinion. There are some materials in the report, and Christina did a good job of segregating things, first of all. But we did find some things that carried over. One of our big concerns is materials like this that potentially could be crystalline or have a crystalline component, if they weren't synthetic amorphous, could impact the report if there were health data.

DR. LIEBLER: Well, the reason we divided the report out to this current version, which was intended to just be synthetic amorphous silica, was to eliminate that concern. But if we still have some ambiguous materials in here, we'd appreciate your input on which ones they are so that we could remove them.

MR. MICHOS: Yeah. Our definition of amorphous synthetic silica -- since you have only two elements there, silicone and oxygen. Those names clearly have aluminum and iron, I believe, if I heard correctly. So it's a different class. They do not belong in that review.

DR. BELSITO: Lithium Magnesium Silicate. Is that amorphous or is that possibly --

MR. MICHOS: It could be amorphous, but it is not silica. It is a form of a silicate which has its own solubilities and its own toxicology.

DR. LIEBLER: Let me approach this a little bit differently. The problem we faced originally with this larger ingredient with some previous reports is that we had some that were synthetic amorphous silica and then some that were mined silicates and so forth that also could contain crystalline silica. And we wanted to remove that issue from our report, the crystalline silica. We did not want to include those in our report.

So, we thought that going to the current list would take care of that. But it obviously doesn't just include synthetic amorphous silica or hydrated silica, which would be the two that would be the simplest guarantee to be just amorphous silica. So we have these others which are mineral silicates. And I guess my question for you is, are any of those produced in a way that would likely lead to their containing crystalline material?

MR. MICHOS: We do not know how these materials have been produced. We can speak in length on how amorphous silica is being produced, again, containing only silicone and oxygen. That's the only thing.

DR. BELSITO: So, basically, what you're saying is, from this list, everything disappears except for silica and hydrated silica? Those are the only ones?

MR. MICHOS: This is correct.

MR. JURD: That would be a low-hanging fruit, easy way to get one report out and then address the other ones, perhaps separately. I still think you're going to have to segregate the other reports, and you could do a synthetic amorphous silicates, and then mined or naturally occurring silicates. And it's probably --

DR. EISENMANN: The problem with the mined versus -- as I understand it, some ingredients are both mined and --

MR. JURD: Yeah, they're synthetic and -- yes.

DR. EISENMANN: So, I don't know if that's the right -- rather than versus -- will it have crystalline or will it not?

MR. JURD: In some previous reports, like one on oligopeptides, we found out that one ingredient name meant as many as five different actual sequences. But we only had data and information for one or two of those sequences.

Synthetic Amorphous Silica and Hydrated Silica – Expert Panel for Cosmetic Ingredient Safety Meeting Transcripts

The approach the Panel took was to give a safety assessment of that ingredient, but only when it was one of those two sequences.

So, there is one potential option to take in this report, is to look at these ingredients, but only when they're synthetic and amorphous; and crystalline or mined is completely left out of the picture because that's not what's under review.

DR. BELSITO: But then how do we make that clear? Because the title will have the ingredient that could either be synthetic amorphous or mined.

DR. LIEBLER: Well, I think we may need to change the title if we change the ingredient list again. We need to further clarify in the introduction what we're reviewing and what we're not reviewing.

I did have another question, and I'm sorry my ignorance of silica manufacturing is limiting here, but are any of the silicates -- is it possible to make any of the silicates in our list by producing synthetic amorphous silica or hydrated silica and then combining them with other metals, for example, to make any of the ingredients on our list? Is that ever done?

MR. MICHOS: I do not think so, but I do not know how these particular ingredients are being made.

DR. LIEBLER: So it seems to me that the most straightforward thing for us to do would be to limit our report to just silica and hydrated silica for this report.

MR. MICHOS: Correct.

DR. LIEBLER: But I was wondering if there are any cousins that are produced from those by a simple procedure of adding magnesium or adding --

MR. MICHOS: If they are physical blends, I would imagine that they can report it as a silica and something else. But I think your suggestion of having a report just for silica and hydrated silica, that would be the most clear, sharp way to do it.

Because that narrows down to materials that have only silicon and oxygen, and there is plenty of background information on how these materials behave, their solubilities. Once you introduce a new element, like an aluminum or a germanium, that's not a silica anymore.

MR. JURD: We do manufacture -- and members of SASSI do manufacture -- synthetic amorphous silicates such as Sodium Aluminum Magnesium Silicate, Calcium Silicate. It's a fairly simple process.

DR. LIEBLER: Well, that's what I was asking.

MR. JURD: Yeah. It's a fair --

DR. LIEBLER: I'm just wondering if we could determine which ones of those fall into this list. In other words, is it more than just silica and hydrated silica that we can include that would fall under the description you just mentioned? We just need to know which ones those are.

MR. JURD: One of the obstacles we face is we're only manufacturing certain of the silicates for certain applications, so we're not looking -- I mean, like the ceramic portions have different applications, probably manufactured by folks outside of our industry area that are using them for different things and supplying different markets.

MR. MICHOS: Is there a downside for just getting silica and hydrated silica, which is something that we can wrap our hands around and understand it?

Synthetic Amorphous Silica and Hydrated Silica – Expert Panel for Cosmetic Ingredient Safety Meeting Transcripts

DR. LIEBLER: So, if we have related ingredients that have similar uses that are used in cosmetic ingredients, it makes sense for us to include them in the same report. Because there would be a lot of mutually supporting data for safety. So, that's why we want to determine the largest possible list of ingredients to include that would be still justifiable based on their composition and use.

MR. MICHOS: Okay. Thank you.

DR. LIEBLER: Sure.

DR. SNYDER: So, it appears to me that we can only have data on one ingredient. It's the silicate -- silica. Because that's the only one we have composition on. We have no composition on any other ingredient in this list, and we just heard that these are very disparate and they're not similar, and they may contain or may not contain. So, as far as I'm concerned, the data is probably sufficient for silica.

MR. JURD: And hydrated silica.

DR. SNYDER: Well, we don't have hydrated. I mean, I don't --

MR. JURD: No, they're very, very similar materials. Silica is a fumed or pyrogenic material, actually much higher. The majority of silica you get is going to be the hydrated version.

DR. SNYDER: But we don't have that composition data.

DR. LIEBLER: So that would be easy for industry to provide us --

MR. JURD: That, I think, is already in there.

DR. LIEBLER: It's not in our report, I don't think.

DR. SNYDER: No, that's not in our report. Because it's on page 120. And we only have composition of silica. So, all the rest of them would be, at a bare minimum, insufficient for composition. And then we'd have to go forward from there.

DR. BELSITO: Well, do we want to even keep them in our report?

DR. SNYDER: I think we're conflicted, because we have old reports that are published with the ones in red, and --

DR. BELSITO: We're going to have to go back to those.

DR. SNYDER: Yeah. So, I think we just need to clear this group somehow, because I'm not comfortable that those old reports had composition data. Because otherwise, we would have it in this report, right? And if it's in the other reports, then let's bring it into this report.

MS. BURNETT: What was in the previous reports has been brought in.

DR. SNYDER: That's what I assumed.

MS. BURNETT: Yeah.

DR. BELSITO: Yeah, I agree. So, what are we doing here? If I understand what you're saying, Paul, is, first of all, we should not expand the group. But we need to -- all the ones that are in black, the silicates, get rid of. But keep the ones that are --

Synthetic Amorphous Silica and Hydrated Silica – Expert Panel for Cosmetic Ingredient Safety Meeting Transcripts

DR. SNYDER: No. At this stage, I think we should keep the report as it is, and an insufficient data announcement continues because we have insufficient composition. Because we don't know how many of them have crystalline silica or how many of them have ceramic or whatever.

Because my concern is that we have published reports that we clearly didn't have composition on. And we're hearing now that the people who manufacture this are concerned that that may not be free of the things that we think they're free of.

DR. BELSITO: Right.

DR. SNYDER: So, we can go ahead and say the silica is safe as used. All the rest of them are insufficient for composition. Depending upon composition, additional data needs may be needed; depending upon the composition.

DR. BELSITO: So what you're saying is even the ones that Carol initially suggested be removed be kept in this report, and all of them -- except for silica and hydrated silica, and we will get composition on hydrated silica -- are insufficient for composition.

DR. SNYDER: That seems the most --

MR. JURD: I do think you do have the information on hydrated silica that's in there. I think it's a -- silica, in itself, is complex by means of manufacture. Hydrated silica and silica are almost equivalent.

DR. LIEBLER: It's the same process with just a different amount of moisture included, right?

MR. JURD: It's different manufacturing processes. And I think, actually, most of the data that's in there is probably actually for hydrated silica, not for what is called silica.

DR. LIEBLER: Okay. So, we may need a little additional information if we may request to you or Christina may request for some clarification on a couple points. Because it seems to me that silica and hydrated are what we will have adequate method of manufacture and composition. And then we won't have it for the others.

So, Don, I agree with Paul's suggestion. Keep the reports. Don't strip it out now. Give industry an opportunity to respond. Because I just look at this California listing, and the fact that you don't have an option to report the amorphous product as an option, I can easily imagine --

MR. JURD: We'll get that --

DR. LIEBLER: Oh, right. Right. But I can easily imagine that driving, at least to some extent, this ambiguity. Because you have no other options. So, okay, stick crystalline.

DR. SNYDER: And then, if we are going to break them out, it'll be based on composition and method of manufacture.

DR. EISENMANN: My concern is not the comp -- maybe I'm not an expert on silicates, maybe, and correct me. But it's not the composition that matters so much. It's how it's --

DR. SNYDER: Impurities.

DR. EISENMANN: No, it's not impurities --

DR. SNYDER: No?

DR. EISENMANN: It's how they're combined structurally. You can have the same composition, but because it has different structure, it could be toxic. Not --

MR. MICHOS: You are correct.

DR. EISENMANN: It's not so much its composition. It gives the elements and what it is except for the impurities --

DR. SNYDER: Well, I was only --

DR. EISENMANN: But it's really more of a structure, and I don't have any expertise on that.

DR. SNYDER: Yeah, I think the method of manufacture and composition will be the driver.

DR. EISENMANN: Well, that's why I'm pointing out ceramic. By that term, in the definition, I think that gives a little a hint that there's a different method of manufacture there, that you're applying heat to this material. And I don't think that happens for some of these other ingredients. And that's why I thought you could throw the ceramics out of this report because they don't belong.

And the zeolites, we've already put in the other report, except this one doesn't have zeolite in the name. It has zeolite in the definition. So, that's why I thought that one should be moved.

DR. SNYDER: But I would also like to -- those ones in red that have already been reviewed and published, I'm concerned. Because there's no data but for to support composition. In this report, they were probably deficient in composition. And we have --

MS. KOWCZ: And we just carried it through.

DR. SNYDER: Yeah. We have new information now, so maybe we'll reopen some of those and bring them into a larger report and get it clarified whether or not they have any issues.

DR. LIEBLER: An alternate strategy could be to just do hydrated silica and silica in this report, and then do a reopen on the others.

DR. SNYDER: I think that's likely where we're headed, but I think we should at least see a body of data first. Because, otherwise, we may not know how to split them up, other than the two you mentioned. But there may be one or two of these that might go well with those.

DR. LIEBLER: Well, that's what I was trying to find out. Are there others that go with silica and hydrated silica very cleanly that could be easily supported?

MR. JURD: I don't know if there's anything that would necessarily go cleanly, because compositions are a little bit different. I think the point made on the structure itself is critical; amorphous versus crystalline is a big issue.

DR. LIEBLER: Yeah.

MR. JURD: There are a small number of the synthetic amorphous silicates that are manufactured by members of SASSI that we do have probably a lot more information on. But if you look at the 40 materials that are in there, I think you could issue an insufficient data call for the next 100 years maybe and never get some information coming back on some of these materials. Because I just don't know -- it's probably small manufacturers that don't ever even see this sort of thing. So, unless it's coming from a specific user of it, I doubt people are going to get it. It occurred to me also in thinking of the California mention of crystalline material and the way California works with Proposition 65 in their labeling, there is no de minimis level for materials that are on Proposition 65. Could they be listing crystalline silica because there are clay components being used in those cosmetics which would possibly and highly likely contain crystalline silica?

Synthetic Amorphous Silica and Hydrated Silica – Expert Panel for Cosmetic Ingredient Safety Meeting Transcripts

DR. SNYDER: So, other than crystalline silica, in your statement in your letter, do you have any data you could share with us where there is a significant difference in systemic toxicity based upon the physical or chemical properties of one of these ingredients? Other than crystalline silica, which we understand.

MR. JURD: We haven't looked at it, but I'm sure there is. Like another one of the silicates -- silica versus another one of the silicates that are listed in there?

DR. SNYDER: Right.

MR. JURD: There might be. We'd have to do data mining. And it's unlikely. We don't manufacture it, so there's no driver for us to go after a collection of that sort of information.

DR. BELSITO: So, just looking at number of uses, clearly, silica and hydrated silica have the vast majority. But there are uses for silicates that are not negligible if you total them all up.

So, I sort of almost agree with what Paul is saying, is to keep all of these in here and to say that -- get a little more data from you on the manufacture and composition of the hydrated silica to include here and go with those safe as used, and all of the others insufficient for structure is what I'm hearing; more chemical composition, impurities, and structure.

DR. SNYDER: But now I'm concerned in systemic toxicity, we don't -- if there is an issue.

DR. BELSITO: Right. Depending upon this, other toxicological endpoints may be needed.

DR. SNYDER: Yeah.

DR. LIEBLER: But it boils down to respiratory is what we're concerned with, the crystalline silica.

DR. BELSITO: Yeah. Right.

DR. LIEBLER: The other issue, that I don't know if we'll ever have the data to get into, is whether or not there's some threshold minimal amount that is without effect for crystalline.

DR. BELSITO: Yeah, I understand. But when you start looking at a lot of these, you've got Sodium Magnesium Silicate as being used in powders and inhalation.

DR. SNYDER: And not to reiterate, but those red ones bothered me. Because when I saw those, I thought there was going to be a lot of composition data to look at and there was none.

DR. BELSITO: Right. Right. So, is that what we're suggesting? Keep everything in as it currently is, get the data for hydrated silica, but at this point saying the silica and hydrated silica are safe as used, and all the others are insufficient for composition, impurities, and chemical structure?

DR. SNYDER: Right. Well, if we get the information on hydrated silica, just --

DR. LIEBLER: Yeah. Oh, we're going to get that. That's coming.

MR. JURD: Yeah, we can just align that or give you the definitional -- because I think the information you have is sufficient. I just think it's -- probably just looking over and making sure there's an understanding on the definitional --

DR. LIEBLER: Right. So, the ones that are in red that we've reviewed previously --

DR. BELSITO: Are now insufficient.

DR. LIEBLER: Yeah, they're going to come up insufficient. And I think what we need to do is explain in our discussion that, at the time we reviewed these, the issue of crystalline silica was not prominently considered by the Panel. And the available data indicates that the crystalline silica is a substantial hazard, and the level of risk posed by these ingredients wasn't able to be considered at the time. Now we're considering it; we realize we don't have enough data.

So, something along those lines to explain we've learned a few things in the intervening years, and we need additional data to support the safety.

DR. HELDRETH: And then when the two-year clock expires, as the gentleman from SASSI recommended that we would probably never get that data, it'll be a use not supported case.

DR. LIEBLER: Yeah.

MR. GERMILLION: It's kind of a remedial question here. I just wanted to confirm; with the synthetic amorphous silica, there's no risk of the crystalline silica being a byproduct or something?

MR. MICHOS: Actually, it's very hard to make crystalline silica in a manufacturing process. The way we make these materials, we combine certain silicate and sulfuric acid, and we precipitate our silica. So, under these conditions, it was never a report of any circumstances to get a trace of crystalline silica formed.

MR. GERMILLION: So, it's only when other things are added to the silica --

MR. MICHOS: In order to form crystalline silica, you need to go to extremely high temperatures in order to form it. So, it's not something that we can routinely make in the lab or in a manufacturing scale.

DR. LIEBLER: It's like the difference between graphite and a diamond. They're both carbon.

MR. MICHOS: Very well said. Exactly.

DR. LIEBLER: But the structure to get a diamond requires a great deal of pressure and heat over a long period of time.

MR. GERMILLION: Oh. So, the crystalline is only in the naturally mined sources. So -- yeah.

MR. MICHOS: You're absolutely correct. It's a crystalline silica, SiO₂, so it has a certain structure and a certain solubility and a certain toxicology. And the silica that we make is, again, SiO₂, but it's a different structure. It's an amorphous material as we characterize it. It has a different solubility and different toxicology.

MR. GERMILLION: So the synthetic materials don't have the crystalline --

MR. MICHOS: It is a synthetic. Yeah, yeah.

MR. JURD: Synthetic's highly pure. You can get naturally occurring amorphous silica. There is some in zeolites - or not zeolites, diatomaceous earth. But it's mixed in with crystalline material.

MR. MICHOS: So, the amorphous part speaks to the crystalline material. And the synthetic one speaks to the fact that we control the way we make it in order to control the properties, and also we control the purity of the material. So, you can mine some type of a silica that can be contaminated with lead or arsenic or mercury. But in the synthetic ones, the purities are much higher.

MS. KOWCZ: So, are we totally clear about how we would categorize this? We're going to call this hydrated silica and silica?

DR. BELSITO: No.

MS. KOWCZ: Keeping everything in. But those are the ones that you're really looking at. You're looking at the hydrated silica and silica.

DR. BELSITO: We're looking at everything. The only ones we're saying are safe as used are silica and hydrated silica. So, I think the title of the report stays the same.

DR. SNYDER: At this stage.

DR. LIEBLER: For now.

DR. BELSITO: For now. I mean, we may decide to just go ahead and do what we talked about, and that is just review silica and hydrated silica if we're not getting any information. I mean, I don't --

DR. SNYDER: I mean, it's an interesting situation, because having so many reports that have already been published, and with --

MS. KOWCZ: It's a long history.

DR. SNYDER: Yeah.

DR. LIEBLER: There are two strategies. One is the one we're talking about where we keep the same title, keep the same ingredients, and we're going to have a bunch of insufficients.

DR. BELSITO: Right. And I think we need to do that, because there are materials that's been used.

DR. LIEBLER: But the other strategy is to just say we're going to eliminate everything but silica and hydrated silica, do that as a report, and re-review the others based on the concern.

DR. BELSITO: But then that's delaying the two-year clock to get the information that we need, and we've already said that the ones in red are safe as used. And now, we're not certain that they are.

DR. SNYDER: We don't know the characteristics of that whole other group to know that we can pair up five more ingredients and clear it, because it does go with the silica.

DR. BELSITO: Right.

DR. SNYDER: So, I think it's premature.

DR. BELSITO: Yeah. But it's also a clock on the other ones that we've previously said were safe as used, when we're now not certain that they are.

DR. LIEBLER: So I'm fine with that. I was just pointing out that there was an alternative approach. I don't think it's as good. But that's what we're going to -- well, assuming we can agree with the other team on it tomorrow, that's what, I think, we're going to do.

DR. BELSITO: Keep the report as is.

DR. LIEBLER: Yeah. We'll see what they say.

DR. BELSITO: Amorphous -- or silica and hydrated silica, safe as used. Others, insufficient for composition, impurities, and structure.

DR. LIEBLER: Right. Method of manufacture.

DR. BELSITO: Method of manufacture.

MR. JURD: But you're going to have a distinction in there. Where I worry with that is we've had silica and hydrated silica being safe for use in a huge number of things. Are we going to throw any -- the cosmetics industry in general, are they going to be concerned about this finding? The change here?

I mean, I just worry about our customers and downstream users and everything like that, what they once thought was established. And I understand they can have questions, but --

DR. LIEBLER: They shouldn't be concerned if they're using silica and hydrated silica. If they're using any of the other silicates for which we don't have sufficient data, then they either need to come up with the data or deal with the consequences of an insufficient conclusion.

DR. KLAASSEN: Or they can start using hydrated silica and silica. That's the logical thing that would happen.

MR. JURD: Yeah. Yeah. Good point.

MS. KOWCZ: I just want to make sure that it's very clear which ones we are looking at right now, which ones we are not, if this is the first strategy that you're going with. Because it will create a lot of concern, I believe. Because we're very clear about the method of manufacturer in the silica and hydrated silica. I really appreciate what you said about the synthetic portion where you can really control the process, you know exactly what you're getting versus mining.

So, I think the mining has to go away in this -- whatever we decide on how we do this, because the hydrated silica and the silica are so very different from all the other materials that you, yourself, say we probably will not get any additional information on. Do we have that right? Or do we still not understand it?

MR. JURD: Not all of them. I believe there are a limited number of the silicates that we can get good information, but it's not all of them; not with the huge number of them that are in there.

DR. LIEBLER: So, for those that we can, we really need it.

MR. JURD: Right. Gotcha.

MS. KOWCZ: Just to minimize the confusion, because we will be the receiving ends of all the confusion, all the questions, and then we will be, obviously, contacting you, which I really don't want to do because this is not the only thing you do in life. So, I just want to make it very clear as to what we need from you and what we would appreciate to get. Because I really want to make sure the Panel has what they need to make the right assessments.

DR. BELSITO: Right. So, if you could provide -- basically, what we're asking for is on all of the materials, other than silica and hydrated silica, if you could get us any information you have on the silicates; and specifically what we're asking for is method of manufacture, composition, impurities, and structure.

MR. JURD: I think we can get that probably for half a dozen or so of the silicates.

DR. BELSITO: That's great.

DR. LIEBLER: Good.

DR. BELSITO: And then maybe about half a dozen that are used, and we can clear them. But right now, we're in an embarrassing situation where we've said some of these silicates are safe as used, and now we're saying that, gee, based upon new tox data that's come out, they're not, or we don't know.

Synthetic Amorphous Silica and Hydrated Silica – Expert Panel for Cosmetic Ingredient Safety Meeting Transcripts

MS. KOWCZ: And it's okay not to know. I think it's all right not to know, because we'll get whatever confirmation we can get from you. And then we just say we don't have this, or it's not used, not produced, whatever.

DR. BELSITO: Right.

MS. KOWCZ: Thank you.

DR. BELSITO: So I just have one question. This is on page 120, PDF 120, under Method of Manufacturing. It says mean particle size, distribution degree of aggregation and/or agglomeration can be determined by adjusting processing parameters. Is that --

MR. JURD: It's not a switching of the dial sort of thing. It's overall manufacturing setup. Demetrius, you probably --

MR. MICHOS: Yes. You're referring to how we control the final particle size of the product?

DR. BELSITO: Right.

MR. MICHOS: The main way we control that is by milling the material. So, there are a number of different ways for us to reduce the particle size, but we rely on particle collision, or a particle under high speeds where the particle fractures and reduces its particle size. That is how we control the particle size in the material.

DR. BELSITO: And then, in formulation, they will further aggregate, so respiratory toxicity is not a concern? Or it's not a concern simply because of the structure of silica and hydrated silica? I'm just trying to get to the discussion part of separating these out from silicate.

So, again, the respiratory issue is they'll further aggregate and won't be respirable; or if they were, that the structure is such that they don't pose an inhalation tox issue? Is it both?

DR. SNYDER: At this stage, I think it is. Because we don't know.

MR. JURD: I think the inhalation --

DR. BELSITO: But we're saying silica and amorphous silica, and we're talking about silica and hydrated silica.

DR. SNYDER: Right.

DR. BELSITO: If they were inhaled, would they create issues?

DR. EISENMANN: If they're cleared.

DR. BELSITO: Respiratory-wise, they're clear.

DR. SNYDER: Yeah. Right.

DR. BELSITO: So, that needs to go in the discussion that, as opposed to silicates --

DR. LIEBLER: Yes.

DR. EISENMANN: Right.

DR. BELSITO: -- silica and hydrated silica do not pose an inhalation risk. Is that correct?

DR. SNYDER: Yes, as we currently understand.

MR. JURD: Yeah. SASSI put a couple other studies cited in the last letter that we sent that were in peer review journals. I don't have the paper, I don't think, in front of me. But they were actually studies done on manufacturing facilities, so people with extensive 8-hour a day, 52 weeks a year exposure, along with typical consumer exposure. And there was no evidence of any additional health hazards. That's just new ones that we had provided to the Occupational Health and Safety Administration when they were looking at the respirable silica rule.

DR. SADRIEH: Do you have only occupational exposure data, or do you have toxicological data on amorphous silica and inhalation?

MR. JURD: We have toxicological data. There are two or three studies that we cited in previous letters. There's also a lot of data in the REACH dossier, the Jack report, the ECETOC report. There's a lot of inhalation tox, even a lot of the inhalation toxicological data, along with a lot of other toxicological data.

DR. BELSITO: Okay. Then, just to follow up on my point about respiratory toxicity, PDF page 126, for hydrated silica; in the treated group, 29.5 percent had increased incidence of overgrowth or hyperplasia of the trachea-bronchial lymph nodes compared to 14 of the controls. Although there was no obvious fibrosis in the lung tissue, there were fibrotic nodules in the trachea-bronchial lymph nodes. This was in mice, a tumor-susceptible strain. That was hydrated silica.

For the silica, the carcinogenic potential was different. So, I just want to understand this hyperplasia of the trachea-bronchial lymph nodes that was increased.

DR. EISENMANN: What concentration was it at?

DR. BELSITO: Mice received 0.5 grams per day of hydrated silica in 600-liter capacity respiratory chambers once per hour, six hours per day for five days per week for one year.

DR. LIEBLER: That's a lot of material.

DR. SNYDER: Yeah.

DR. LIEBLER: I mean, that's a --

DR. BELSITO: So what you're saying is this is just the lymph nodes clearing stuff --

DR. LIEBLER: A high load.

DR. BELSITO: A high load.

DR. LIEBLER: Yes.

DR. BELSITO: So, that would need to be in the discussion as well.

DR. SNYDER: Right. The exposures for incidental inhalation at the levels that we're talking about would never, ever approach that.

DR. BELSITO: Well, I mean, I'm just pointing it out because the intratracheal for silica was totally clean. The incidence of tumors were the same in the treated and control group, essentially.

Okay. So we just need to say that in the discussion that it's a very high load and that the lymph node hyperplasia was just simply reactive, clearing such a high load.

DR. SNYDER: It exceeded the capacity to clear it, so --

DR. BELSITO: Right. Okay.

DR. SNYDER: Certainly no carcinogenic signal there whatsoever.

DR. BELSITO: Right.

DR. LIEBLER: And the carcinogenesis assays with a much lower dose for a shorter period of time.

DR. BELSITO: Okay. And then, under occupational exposure, we clearly state that we're not looking at -- I guess, now, we need to get rid of the statement that we are looking at synthetic only, because we're not sure that all of them are synthetic only.

So, in the introduction, we need to get rid of that. And therefore, I guess the occupational exposure in minors with the fibrosis and pneumoconiosis needs to be kept in here. I was thinking it should be removed, but I guess not.

MS. KOWCZ: Dr. Belsito, can we just ask one question since we have the experts here? Should we keep the synthetic word in the discussion piece? Because, from what I understand, when you synthesize, you can really control the process. You can control the output, to say in a very simplistic way. Would you still keep the synthetic wording in that discussion?

MR. JURD: From our aspect, yes. All the silica/hydrated silica we manufacture is all synthetic. And that's critical for us because, like you said, the purity and everything else.

MS. KOWCZ: I just wanted to make sure that we're very accurate, specifically since you're taking so much time to make it right.

DR. SNYDER: Yeah. Can we get clarification as to what box they checked? Was it just a box that said silica on the reporting that Dan was asking?

DR. BELSITO: The California report?

DR. SNYDER: In California, yeah.

DR. EISENMANN: It says crystalline silica.

DR. SNYDER: It says crystalline silica.

DR. LIEBLER: In California, apparently, according to Paula Johnson's email, the only option in California is to check crystalline silica. You can't check anything else. And if you produce synthetic amorphous silica, which is really not crystalline silica, but you want to report it in California, you either don't report it or you check crystalline silica.

DR. BELSITO: Yeah. I think we should write a letter to them stating that the Panel was concerned that there could potentially be misreporting since there's not the opportunity to --

DR. EISENMANN: Well, this is in terms of -- we're asking companies to report things that are considered carcinogenic. Amorphous silica is not carcinogenic, so you don't have the option to put it there.

MS. KOWCZ: Well, that's what we're saying.

DR. BELSITO: Yeah. But I think what we're saying is that there should be, on that checklist, a big caveat that if you are using amorphous silica, you do not need to tick this box or something to that effect, that the Panel is concerned that the reports --

MS. KOWCZ: It's misrepresented.

DR. BELSITO: -- of use in California may be misrepresented due to misunderstandings of the individuals who are inputting the data; and that that should be clarified in some way that, if you are using amorphous silica, you do not need to tick this box.

Or, on the other hand, they put it in realizing that it's not carcinogenic and then they discount it in the State of California. They put both options in.

MR. GERMILLION: It could also be that they have silicates in their ingredients, so there's some crystalline silica.

DR. BELSITO: Yeah. But if you looked at that tick box, even if you assume all of the silicates we're looking at are not amorphous, the number that they're reporting is significantly higher than the number we're seeing being used in cosmetics.

MR. GERMILLION: So, it could be some misreporting and some that are --

DR. BELSITO: Some that are real, for sure, if you're looking at what we're being told is used in terms of number, assuming all of them are, in fact, not amorphous; all the silicates we're looking at are not amorphous. But you can't get up to the number that they're reporting unless we have total misinformation from VCRP and from PCPC or they're reporting a large number of uses of silica and hydrated silica.

So, I think a letter should be drafted pointing that out, that clearly there's misrepresentation on their database based on the information we have.

You can actually count up the number of silicates that have been reported and say there's just no way; the people are obviously misreporting. And you need to somehow correct the site, either by giving them the option of ticking amorphous silica, realizing it's not carcinogenic, but then you discount that information. Or you put a caveat that you do not need to report amorphous silica or silica and hydrated silica. Or amorphous silica, however you want to put it. But that website needs to be clarified.

MR. GERMILLION: Is it possible, also, as was suggested in the letter, to reach out to some of these companies and ask, what's the ingredient that's causing you to report this?

DR. BELSITO: It's a lot of work.

MR. GERMILLION: Just a sample of them.

MR. JURD: Because I think it might be clays. I have a strong suspicion with some of the products that are out there. Mud masks, they're clay-based. Just my gut feeling.

DR. EISENMANN: Quartz is an option to select. And if you search quartz, you get a different answer. I'm not sure. You might have to report. Is it every SKU in California?

MS. KOWCZ: Yeah. Every SKU.

DR. EISENMANN: So, it might be, whereas like the VCRP, I think you can -- if you have multiple shades of something, it's like, one. Whereas, in California, if you had multiple shades, it might be each one.

MS. KOWCZ: It's each one.

DR. EISENMANN: So, that's one of the reasons why California might look large.

Synthetic Amorphous Silica and Hydrated Silica – Expert Panel for Cosmetic Ingredient Safety Meeting Transcripts

MS. KOWCZ: Like when you have different eye shadow, let's say, just for example, or different foundations, and you're using this material. You have to report every single SKU, which means every single formula, every single variant, that kind of thing. So, maybe that's escalating the number or increasing the number. I don't know. It's just a thought.

DR. BELSITO: Okay. So we're keeping all of the ingredients in. We're saying that silica and hydrated silica are safe as used. In the discussion, we're pointing out the trachea-bronchial lymphadenopathy as being just an overload. There's no carcinogenic potential, no real respiratory toxicity to silica and hydrated silica; and that the other ingredients in this are insufficient for method of manufacturer, impurities, composition, and structure.

DR. SNYDER: It was toxicity, but just at levels that could never be approximated with -- yeah.

DR. BELSITO: Right. Yeah. And depending upon that information, other toxicologic endpoints, primarily respiratory, would be needed.

DR. SNYDER: Yep.

DR. BELSITO: Are we okay with that?

DR. SNYDER: Um-hm.

DR. BELSITO: And then that puts the ones we previously approved on a two-year timeline. If we don't get the data, their use would not be supported.

DR. LIEBLER: Yes

DR. SNYDER: Correct.

DR. BELSITO: Okay. So that solves the issue? Okay.

DR. LIEBLER: We thought silica could be so easy.

MR. JURD: Can I ask one question? The report would not be finalized until the two years? Or --

DR. BELSITO: No, the report will be finalized. It's just that the silicates, everything that we said is insufficient, industry has two years to respond. If they don't respond within two years providing us with the data to determine safety, then instead of being insufficient, they're moved into a category, "safety not supported."

MS. BURNETT: This report going out of this meeting is going to be a tentative amended report. The next time the Panel looks at it, it will be a draft final amended report. After that meeting, it may become a final report.

DR. LIEBLER: Doesn't necessarily mean you have to come back and see us. But --

MR. JURD: Oh, I'd be happy to.

DR. LIEBLER: There are other opportunities.

MR. JURD: Okay.

DR. SNYDER: We appreciate your input.

DR. LIEBLER: Yes, really great input. Thanks.

MS. KOWCZ: Thanks.

Synthetic Amorphous Silica and Hydrated Silica – Expert Panel for Cosmetic Ingredient Safety Meeting Transcripts

MR. JURD: No. Thank you for having us.

DR. BELSITO: Anything else? Everyone is clear on what needs to be done, and Carol does not need to search the companies to find out what they're reporting? Okay. Go ahead.

MR. GERMILLION: Well, no. I would just -- I think that would be helpful to see, even if you just contacted two or three of them, just --

DR. EISENMANN: The problem --

MR. GERMILLION: Or any of them actually reporting --

DR. EISENMANN: The problem is it changes so much. So, I might contact them tomorrow and then -- to sell the product off. It just is such a moving target that I'm not sure it really adds anything. Your conclusion will be for amorphous silica, and they will need to follow it.

Marks' Team Meeting – June 6, 2019

DR. MARKS: So Christina sent us a draft tentative amended safety report of silica and synthetically manufactured silicate ingredients. That memo is dated May 10 of this year. At the April meeting this year, the panel tabled a report that contained 40 ingredients in order for -- it says the CIR staff, but I imagine that means you, Christina -- to reorganize the ingredients in two separate reports -- one containing 24 ingredients, I assume, to be synthetically derived. And of course, the respiratory toxicology is very important, comparing the synthetic derived versus the other 16 ingredients that are assumed to be mined.

The data for ingredients, if they're still considered insufficient, the safety was the range of particle size, chemical characterization, method of manufacturing. There was no new unpublished data, but we did receive some letters. So in this split out report, we have the 24 synthetically manufactured ingredients.

Ron and Tom, not only do I want and need your comments, but do you like this new grouping of ingredients?

DR. SHANK: I do, yes.

DR. SLAGA: I do, yes.

DR. MARKS: Okay. Good. And then, are we concerned still about respiratory toxicology with this? Is it still insufficient for the particle size, composition, and method of manufacturing? We have the Women's Voice for the Earth Letter dated 5/28 talking about crystalline silica in cosmetics, particle size.

And then we have this Synthetic Amorphous Silica and Silicate Industry comments dated May 31 of this year. Then we also have an email from Paula Johnson, PhD, MPH, from the California Safe Cosmetics Program Lead Occupational Health Branch concerning what is found in cosmetics in the state of California.

So Ron, I'll let you take the lead. But Tom -- by identifying the most concerning issues about this.

DR. SHANK: The body of the report makes it clear we're reviewing amorphous silicates and not crystalline. It might be wise to put amorphous in the title, so it says synthetically manufactured amorphous silicates. Apparently, crystalline silicates are used in some products but not reported to the council. But this report is just on the amorphous. We're not considering crystalline. So I don't think that's an issue.

Regarding the inhalation toxicology information, the test levels used for inhalation toxicology were very high compared to concentrations in cosmetic formulations. Also, they tested the silicate itself. Whereas, the silicates in

formulations are in formulations, so there's aggregation and other things to consider. I don't think inhalation is a problem with these ingredients. What else?

DR. MARKS: Now, as I recall, let me get my notes out here. One of the issues with the Women's Voices for the Earth, I believe, was this -- is it called jet milled?

DR. BERGFELD: Propulsion, yeah.

DR. SHANK: I brought that with me, somewhere.

DR. SLAGA: That letter was very detailed. I give the person credit to put a lot of thought in it, you know.

DR. BERGFELD: Yeah. It took a long time.

DR. MARKS: Can you hear that? I think it's important. I did not ask, but if there's a representative from the Women's Voices for the Earth, certainly we'd like to hear from you, if there's somebody present.

And then, obviously, I think also from SASSI -- there was an individual from --

MR. JURD: Yeah. There's two of us here, actually.

DR. MARKS: Good. Okay. So in a minute, I'll ask your comments. Don't let us move on before we get your input. I think that's very important.

Yes. So I think the letter dated May 28, as you said Tom, was thoughtful and concern over the use of crystalline silica in cosmetics -- that was in response -- we got the response from California. But I don't think that really -- whether it's being used or not, it doesn't affect our conclusion really. It's up to, when we have a conclusion, for industry to read our conclusion and the FDA to enforce it if necessary.

DR. ANSELL: That this report is focusing on amorphous not crystalline.

DR. MARKS: Right. Exactly.

DR. SLAGA: And Ron wants that in the title, which I think would be very good.

DR. ANSELL: And we fully agree with that -- that this is about amorphous. Just as an aside, the 44 database is not a database of ingredients used. It's a database of reported uses. We know that there's serious errors within the database. It's very searchable and very friendly, but not particularly reliable.

So when we talk about it, it's reported uses. It's not clear that the users distinguish between crystalline and amorphous. They use generic terms, and the database contains reports on materials which clearly are not used.

DR. MARKS: Ron Shank, just to go back, where you would like amorphous -- to put in the assessment of amorphous silica and synthetic manufactured, so amorphous is right up front. Because if you put amorphous ahead of synthetically manufactured silicates, one might say, "Well, what is silica?" Where did you want the word amorphous inserted in the title?

DR. SHANK: Let me find it here.

MS. BURNETT: Shouldn't it be amorphous silica and -- assessment of amorphous?

DR. SHANK: Yeah. I guess it would be best to put assessment of amorphous silica. Are all synthetically manufactured silicates amorphous? Probably. If there's a doubt, we should put it in front of both, amorphous silica and synthetically manufactured amorphous silicates.

DR. MARKS: Is that from a manufacturing vantage point? Because I think if you only had amorphous in front of one or the other, one might then question --

MR. JURD: I would agree. Because you can have the naturally occurring amorphous forms, so we'd want to make that distinction; because those are primarily amorphous, but I believe there's also much higher potential for crystalline contamination in those, if it's a naturally occurring. So I think that makes sense, yes.

DR. ANSELL: But the synthetic may be both amorphous and crystalline, depending on -- well, regardless, the report's on amorphous, so we need to attend to both --

DR. MARKS: Yeah. I think because it makes it clear --

DR. ANSELL: As long as we say that we're not covering the crystalline forms, I think you're --

DR. MARKS: I think that's crucial in terms of the inhalation --

DR. MICHOS: And the word synthetic, if I may add, points to the controlled manufacturing process. And the raw materials are going in terms of heavy metal contaminations. So we want a synthetic and an amorphous.

DR. MARKS: Can you hear that? And if not, maybe come up here near the microphone and identify yourself, if you don't mind.

DR. MICHOS: My name is Demetrius Michos. I'm with WR Grace, and we represent SASSI today. As far as the synthetic part of the nomenclature, I think it points to the fact that we control the raw material that we use to manufacture the synthetic amorphous silicas. So we control the waiting period. So to fully characterize the material, we would like to have a synthetic and an amorphous one.

DR. MARKS: If we take from the title-- SASSI is Synthetic Amorphous Silica and Silicate Industry Association, just to clarify what SASSI is. And you can see where amorphous is inserted there. So Ron Shank, thank you. I think probably putting it in twice, it would prevent confusion.

DR. SHANK: It's clear in the body of the report.

DR. MARKS: Yes, absolutely. But I think the title is --

DR. SHANK: The title needs to --

DR. MARKS: Yeah. The second point from the Women's Voices for the Earth, that May 28 letter, concern about particle size of cosmetic powders. The milled to smaller than 10 microns will agglomerate -- aggregate.

And then there's two articles on jet milled cosmetic powders. And the issue with deagglomeration is mentioned, too. So that second point is actually quite detailed with two references. One is fine beauty triple jet milled makeup, and another one was moisture sensitive materials and deagglomeration application solution.

This will clearly be in the minutes. Ron, your comments earlier about the lack of inhalation toxicity is still relevant in reference to this -- these comments from the Women's Voices for the Earth?

DR. SHANK: We have inhalation toxicology data, but this is on silicates themselves in concentrations which are well above those used in formulations. And the silicates in formulations are not the same as pure silicates being inhaled because they're in formulations. There will be aggregation agglomerates formed. I don't think there is a problem the way they're used now in inhalable products.

DR. BERGFELD: Could I ask a question?

DR. SHANK: Sure.

DR. BERGFELD: Do you think -- this is in the mineral makeups. And being a little bit familiar with that, these are crystalline, are they not? The mineral makeups that they spray are crystalline, or are they amorphous?

DR. SHANK: For the inhalation studies?

DR. BERGFELD: Yeah. This is fine. The triple jet milled makeup letter and they're talking about the mineral makeups that women spray. And I thought that, looking at the particle sizes, as you were pointing, 0.25 to 15 microns. It's a powder.

DR. SHANK: Let me see where that is.

DR. BERGFELD: It's on page 3 of the Women's Voices for the Earth.

DR. SHANK: Page 3 of what? It's not in here.

DR. BERGFELD: Women's Voices for the Earth. It's their third page under fine beauty. Here. I'll give it to you. My interpretation, it might be -- that gives you particle size up to 15 microns.

DR. HELDRETH: Also, I'd like to make it clear that this information that they've cited here is not a peer reviewed journal. It's essentially a blog.

DR. MARKS: Yeah, exactly. That's why I don't -- that's why I mentioned earlier that it will be in the minutes. I don't think -- without having a peer reviewed journal or industry source, we probably would not -- at least reference it. Although, if we mention this jet milled makeup in the actual report, then we have to have some sort of reference. Did you want to respond to the issue with this triple jet milled makeup? Did you see this?

DR. BERGFELD: I have a copy here, if you'd like.

DR. MARKS: And as Wilma said, it says the jet milled materials vary in size from 0.25 to 15 microns.

DR. ANSELL: So the question is particle size, or the question is the crystalline?

DR. BERGFELD: Both, I think.

DR. ANSELL: Well, to the extent that it's not amorphous, then it's not in this report.

DR. MARKS: Correct. I don't think that's an issue.

DR. ANSELL: The problem we continue to have with the Women's Voices focusing exclusively on particle size is that particle size is just one parameter. What we're really interested in is dose, not particle size.

And if you look at the inhalation studies, the animals were exposed for four hours -- six hours a day for concentrations exceeding a milligram per cubic meter. So the doses are quite high in comparison to the human exposure, which was typically seconds a few times a day.

So the doses, while the particle size might be a respirable fraction, are still microscopic -- trivial in comparison. So there's significant safety factors built in, even at equivalent concentrations, just in terms of duration. So we continue to believe that the dose from these materials is exceedingly small, regardless of percent of the particles which may be in the respirable range.

MR. JURD: So without saying there is a hazard -- they're looking at hazard, not risk.

DR. ANSELL: Yeah. They're not even looking at hazard, per se. It's just the respirable fraction.

DR. MARKS: We obviously want to capture that, I would think, in the discussion. And Ron Shank, you had -- I can't get away from that since there are two Rons.

DR. SHANK: That's okay.

DR. MARKS: Ron, I think Jay has just summarized, perhaps in a little bit more detail, what you're feeling, that the inhalation tox studies in the report -- when you put it in the perspective the way Jay put it, endorses the safety.

DR. SHANK: Correct. That's right.

DR. BERGFELD: Can we define if it's crystalline or not? Because that, I think, is an issue as well. Is this a crystalline?

DR. ANSELL: If we take on crystalline at some point in the future --

DR. BERGFELD: No, I know. But if you define it -- where this is a report from the crystalline, not the amorphous.

DR. ANSELL: I don't know where Women's --

DR. BERGFELD: Does SASSI know what this is?

MR. JURD: I'm not aware of this application.

DR. MICHOS: Is there an underlying material here that we need to focus on? There's only a particle size, but that particle size refers to what material? Is it sugar? Is it wood?

DR. BERGFELD: The minutes should reflect that it's not clear what this was.

DR. ANSELL: I think our position is that we would fully support an assessment of amorphous. Crystalline is not logically similar enough to be grouped together in any type of common report.

DR. MARKS: So before we move on, I think tomorrow -- at least at this point -- I'll be seconding. We'll see what the other team proposes. But a tentative amended report with safe. Formulated being non-irritating because, previously, we had determined it can be somewhat irritating. And then we deal with the inhalation in the discussion, in detail.

And then, as you mentioned, the time exposure is much greater in the inhalation animal studies versus what the real-life exposure for humans would be using cosmetics. And amorphous in the title in two places, in front of the silica and synthetic.

DR. BERGFELD: Do you want to put it in the conclusion, as well -- to repeat it?

DR. MARKS: Yeah. I think that's perfectly fine; the present uses, yeah. Ron Hill has a relatively lengthy -- comments about the silicates. I'm going to share that with you, too, Christina, because he had some comments that will be relevant. My sense was he was still on the fence, but he hasn't participated in this discussion.

Are there any other comments from the SASSI?

Synthetic Amorphous Silica and Hydrated Silica – Expert Panel for Cosmetic Ingredient Safety Meeting Transcripts

MR. JURD: Yeah. We do appreciate your understanding of the inhalation and crystalline versus amorphous. But we are still concerned, even though we do represent the synthetic silicates industry also, that silica itself is very well characterized as far as health hazards and toxicology and everything else.

A lot of the silicates -- and we do appreciate Christina doing the work and figuring out what goes in what bucket. There's not a lot of data on some of these silicates that are out there. And lumping them all in, we're worried that if there is some sort of unique toxicology it could impact -- something that comes out in the future that's studied, it could impact the whole study.

DR. MARKS: Yeah. We always struggle with that. I shouldn't say struggle, but consider that when we do the, quote/unquote, "read acrosses."

MR. JURD: Right.

DR. MARKS: And then, our conclusions at this meeting -- we always will reopen an ingredient if there's new toxicologic data or an alert that we should reopen it and reconsider that group. So it's not like this is finalized. There is a standard rereview every 15 years. But if something comes up before we reopen the ingredient -- so unless, Tom or Ron, you want to comment -- or Bart, we had those same concerns. But we feel that we can read across with what we have at this point.

MR. JURD: Okay. And assess the silicates that are in there are of equivalent safe?

DR. MARKS: As long as they're using similar uses and concentration.

DR. SHANK: And amorphous.

DR. MARKS: Well, we mentioned amorphous multiple times, so we're not dealing with crystalline in this -- other than, in the discussion, we'll make it very clear -- and perhaps elsewhere -- that we're dealing with amorphous. That's why I think in the title and the conclusion is a good idea. Wilma, thank you for suggesting in the conclusion, also.

Ron and Tom, I assume that's fine with you to put it in the conclusion.

DR. SLAGA: That's fine with me.

DR. MARKS: And again, it decreases the potential of misinterpretation.

DR. BERGFELD: Could I ask another question? I said that in many of our documents for this time, as well as a little bit in the past, we talked about aggregate accumulation. Is there any sense of worry with this one, of aggregate -- other associated exposures other than cosmetic, or multiple cosmetic ingredients containing the amorphous silica?

DR. SHANK: For inhalation?

DR. BERGFELD: Anything, because we've been adding paragraphs about the aggregate should not exceed -- are we not worried about the aggregate exposure?

DR. SLAGA: That's kind of difficult. You would have to pool a lot of reports to do a comparison.

DR. BERGFELD: So you're recommending not to address that at this time?

DR. SLAGA: I think we have to deal with the data we have here. Aggregate --

DR. BERGFELD: Well, we have been including it.

DR. SLAGA: There is a problem with -- you have to add up everything. But how do you do it in this particular report?

DR. ANSELL: The aggregate challenge is not cosmetic.

DR. BERGFELD: No, it's the other exposures, as well.

DR. ANSELL: Right. It would be non-cosmetic -- potential non-cosmetic exposures. And you're right. That becomes very complicated. We're really just focusing within our reports on cosmetic applications.

And to that extent, they include all the cosmetic applications that have been reported. Topical. Whether there's a potential amorphous silicate exposure from the use of rugs -- I don't know what else silicates would be used in. That would be a challenge beyond what we can address right now.

DR. BERGFELD: I just want to make sure we address that because it's becoming an increasing issue in many of our reports.

DR. MARKS: As I recall, there's a reference to that in SASSI's memo from the last meeting or meeting before. One of the points that dispute the safety of the amorphous silica and silicates is that in the industry where these are manufactured, where you would think a great deal more exposure, there's not been the pulmonary toxicity. Is that correct?

MR. JURD: Yeah. There are two studies I think we cited in our last letter that came out of a study on five German synthetic amorphous silica manufacturing plants where you've got workers of 40 years getting inhalation -- ingestion through normal -- and that's dermal exposure, everything else. And the study was that there was no significant health impact. So that's coupling on their exposure to the exposure that the general public --

DR. BERGFELD: Exaggerated.

MR. JURD: Yeah. Exaggerated.

DR. MARKS: So that, to me, reassured me that, if in this occupational setting and that extent -- it sort of also speaks to what you brought up Jay. The exposure time in the animals is much greater than with the cosmetic exposure. You brought that up, Ron. And then, now this also -- you would expect the exposure in this occupational setting to be multi-times greater than what would be in a cosmetic exposure. And that was in a peer reviewed journal?

MR. JURD: That was in the *Journal of Occupational Environmental Medicine*.

DR. MARKS: And that's in our report?

MR. JURD: That's in the --

MS. BURNETT: The memo that he --

DR. MARKS: Yeah. I know the memo, but is it in our report, Christina?

MS. BURNETT: I don't think so, but it will be added.

DR. MARKS: Okay. It will be added. Good. I think that's important.

MR. JURD: We actually had submitted that to OSHA previously during their respirable crystalline silica rule work.

Synthetic Amorphous Silica and Hydrated Silica – Expert Panel for Cosmetic Ingredient Safety Meeting Transcripts

DR. MARKS: So I expect we'll have a -- we'll see what the discussion tomorrow is, in terms of robust discussion, again on the inhalation issue. But again, Tom, Ron, tomorrow I plan on, for our team, seconding a tentative amended report safe when formulated to be non-irritating. And the inhalation issues will be robustly discussed in the discussion portion of the report. And I don't think it has to be even mentioned in the conclusion.

Does that sound good, Tom and Ron?

DR. SLAGA: Yes.

DR. BERGFELD: Can you make a recommendation to have a separate document for crystalline?

DR. MARKS: I think that's in the minutes, and that will appear, since we are -- it will be clear we're only talking about amorphous. We've made that really clear.

In the introduction, Christina, if you can indicate -- I think probably in the introduction -- the difference between amorphous and crystalline silica and why we're limiting it just to amorphous in this report. I think that will be clear.

DR. LORETZ: There's a sentence in the chemistry that specifically says crystalline silica forms are not used in cosmetics. That's the thing that Women's Voices objected to. That doesn't really belong in this report.

DR. MARKS: Right.

DR. LORETZ: Okay. So that's going to be removed.

DR. MARKS: Thank you, Linda. Exactly. And I think that's the point that -- that part of the Women's Voices for the Earth is easy to deal with.

DR. LORETZ: Yes, exactly.

DR. MARKS: Now, read that sentence again. I'm sorry, Linda.

DR. LORETZ: In so many words, it says "Crystalline silica forms are not used in cosmetics."

DR. MARKS: Yeah. I think strike that sentence. We don't have to reference the California note here. That will be in the minutes, because I think that's one of the concerns that, indeed, crystalline may be used.

DR. LORETZ: Right. We can't say --

DR. MARKS: But at least for our -- yeah. And I don't know that we need to go into discussion as into the database in California where they say it's used. This report is not whether it's used or not used. It's amorphous safe.

DR. LORETZ: Exactly. Separate issue.

DR. MARKS: Well, this was a good discussion. Anything more, Ron? Tom?

DR. SLAGA: Not here.

DR. MARKS: And Ron, as we get into the inhalation, even though I may summarize it, I'll probably ask you to clarify if I don't make the points clearly.

DR. SHANK: Okay.

DR. MARKS: And that will be, I'm sure, in the comments, Wilma. As you know, you're welcome to comment tomorrow, also, at the full panel meeting --

Synthetic Amorphous Silica and Hydrated Silica – Expert Panel for Cosmetic Ingredient Safety Meeting Transcripts

MR. JURD: Okay. We'll be here tomorrow.

DR. MARKS: -- if there are some things that need to be clarified. Thank you.

MR. JURD: No, thank you.

Full Team Meeting – June 7, 2019

DR. BELSITO: Someone hates me, gives me all these ingredients. Okay, so at the April 2019 meeting we decided to table the report and split the ingredients. We were then looking in to two separate reports, one containing 24 ingredients that at the time we assumed were synthetically derived. And the other containing 16 ingredients that we assumed were mined.

Yesterday we learned that with the exception of silica and hydrated silica, all of the other ingredients in this report could potentially be mined. We weren't certain as to exactly how they were manufactured. And, therefore, based upon that, based upon the fact that we have ingredients in this report that we have previously gone out and said safe as used, we felt that we could reach a conclusion that silica and hydrated silica were safe as used.

The others were insufficient for method of manufacture, composition, impurities and structure. And depending upon these, other toxicological endpoints may be needed.

DR. BERGFELD: And that's a motion?

DR. BELSITO: That's a motion.

DR. BERGFELD: So it's half and half.

DR. BELSITO: No, it's two versus a whole bunch of others that are insufficient.

DR. BERGFELD: Okay.

DR. MARKS: Two, with 22 that are insufficient.

DR. BELSITO: Right.

DR. MARKS: That's interesting. Our team didn't realize that there might be non-synthetic silica in those other 22. So, I have no problem in terms of seconding that motion, but Ron and Tom, I'd like your input. And, we do have some comments, like we feel amorphous should appear in the title and the conclusion, so that we stress that. But now that we have this nuance that amorphous may not be totally amorphous.

And then, the other thing is that we felt the inhalation toxicity in animals were not directly relevant to the human, since the time exposure is much greater. So, in this case, sort of adding on to our inhalation, a boilerplate particle size is not as much importance in this case, but time and exposure. And, Jay, you brought up that point yesterday. You clarified or expanded upon it, if I haven't translated what you said correctly.

But, Ron and Tom are you fine with that tentative amended report conclusion?

DR. SLAGA: I'm fine with it. I liked the way you've handled it.

DR. BERGFELD: Ron?

DR. SHANK: I found that the report is on amorphous silicates.

DR. BELSITO: Maybe we can have the representative from SASSI come up and -- yeah, that's what it says it is. But we were told that there may be six ingredients that are purely synthetic, but some of the others could be mined. If you look at the definitions, one of the ingredients is defined as a zeolite, which would suggest that it's mined. And the other two were defined -- or there were three that were defined as ceramic, which suggested that it could be mined. And, the representative from SASSI, well you can speak but the only ones right now that you're certain are completely synthetic would be silica amorphous and hydrated silica, correct? And you were going to look into the others.

MR. JURD: Tricky question. Synthetic amorphous silica is what we manufacture and it's definitely distinct from the other materials.

You can get amorphous silica naturally occurring, and, like diatomaceous, or it does contain a small portion of that, although it's tied in with crystalline silica too.

We do manufacture a number of synthetic silicates. There are a large number of the silicates that are in there that I believe -- and based upon our information, which is very minimal because we don't manufacture them, so we don't look a lot at materials we don't manufacture -- but I believe a lot of those are mined.

So, all I can say is that with the report as it is, if we do it for synthetic amorphous silica, or synthetic amorphous silicates, with the limit being those ones we actually manufacture, we'd be okay with that.

But there is a lot of uncertainty with a lot of the other materials. Zeolites can be both naturally occurring and synthetically made. And there are a huge number of different zeolites out there. I mean, probably hundreds, if we open that can of worms, which you probably don't want to do. Because I don't think they're used in the cosmetic industry.

DR. BELSITO: So that's why we need to know particularly the chemical structure of these materials that we're reviewing as a cosmetic ingredient. Because it's not just, you know, it's the structure -- I mean, it's not just the composition and manufacture; it's actually the structure of the material that will have the toxicological effect.

DR. SNYDER: Like, I think you'd stated yesterday that composition was essential to determining, in some of those mined, that there is absolutely no crystalline silica present.

MR. JURD: Well, so it's almost impossible to make synthetic crystalline forms of materials. That's almost, I mean, Demetrius, you said that. So that's basically impossible. So what comes out synthetically is almost always going to be amorphous.

Though we don't look at the mined materials because the purity of those is just, they're hard -- you can't sell them. We can't process them, that sort of thing. So it's not the kind of materials we delve into, our organizations.

DR. MARKS: So, as we're talking, my thoughts are that if we're not sure, or there are potentially mined silica in some of those ingredients, and they should be eliminated from this report. And rather than an insufficient, and we only deal with amorphous silica --

DR. BELSITO: The issue is that we said that some of the ingredients are safe as used and now we have concerns. And if we remove them from the report, then there's no clock ticking for industry to provide us with data. And if, in fact, there is a concern and we issue the report as it now is, in two years if we don't get data the conclusion will be changed to not supported.

DR. MARKS: Then my suggestion, that would be is that mined silica be at the top of the Priority List.

DR. BELSITO: But we don't know --

DR. MARKS: We already decided we'd separate these two reports, and now we find the ingredients in this report.

DR. BELSITO: We don't know yet. That's why we're asking for the data. And it may not be necessary to separate all of these out.

DR. LIEBLER: So, one of the points that our colleague from SASSI made, just now in passing and yesterday a bit more in our discussion, was that not only silica and hydrated silica are synthetic amorphous, but he said that some other silicates are also synthetic. And I'm not sure which of the ingredients on our list are those synthetic silicates that are not crystalline, not mined. And, so, it may be that in addition to the silica and hydrated silica, some of those

Synthetic Amorphous Silica and Hydrated Silica – Expert Panel for Cosmetic Ingredient Safety Meeting Transcripts

silicates may justifiably be carried forward through the safety assessment. But we don't yet have that information as to which ones they are.

DR. SHANK: Can that be handled in the discussion, that the report is limited to only amorphous forms.

DR. BELSITO: Well, it will be. But we still don't have the data to support that the others are necessarily amorphous.

DR. SNYDER: All the ones that we had that are approved.

DR. BELSITO: Pardon?

DR. SNYDER: We have all these in red that are in previous reports safe as used, but there are no composition data in any of them. Because I asked Christina, she said there were none to bring forward because there is no composition data in any of those. So we're a little concerned about what exactly are those and where do they fit in this big group.

DR. BERGFELD: Is there general agreement to agree with the Belsito team's conclusion?

DR. MARKS: No, I just -- if we're going to have two reports, then what's the second report and when is that going to come out?

DR. SNYDER: We don't know.

DR. BELSITO: I think the second report will depend upon how we define the amorphous silica group, and we haven't done that yet because we don't have composition and structure, and method of manufacture for all of the others. So until we get that, we don't know how to define.

And, in order to try and expedite it, since there are large number of materials here that we previously said were safe as used, and now we have concerns that they may not be, we want to just proceed with this report as it is and try and get clarification on what are the amorphous silicates in here and what are possibly mined.

DR. MARKS: And that would be -- so, again, Don, your motion is to issue a tentative amended report with a couple of the ingredients safe. You didn't mention nonirritating, but I assumed formulated to be nonirritating, which that was in the past.

DR. BELSITO: Right.

DR. MARKS: And then a number of ingredients was at 22, which are insufficient data.

DR. BELSITO: So silica and hydrated silica are safe as used and formulated to be nonirritating. The others are insufficient for method of manufacture, composition, impurities and structure. And depending upon those issues, other toxicological endpoints may be needed.

DR. MARKS: It's been a long discussion, so I don't remember whether are team seconded that motion but I will.

DR. BERGFELD: We'll second again.

DR. MARKS: Second it.

DR. BERGFELD: Thank you. All right, any other discussion regarding the silicates? Hearing none, call the question, and all those in favor of this conclusion? Thank you. Unanimous. Well that was a bag of worms. Thank you, Don.

SEPTEMBER 2019 PANEL MEETING – DRAFT FINAL AMENDED REPORT

Belsito's Team Meeting – September 16, 2019

DR. BELSITO: Okay. So we got a letter from SASSI telling us that calcium silicate is made from amorphous silica and therefore we should clear that, is essentially the way I read it.

DR. KLAASSEN: Correct.

DR. BELSITO: But then it said the amorphous silica is made with sand. So I'm not a chemist. Does that mean it can't contain these crystalline structures? I mean the ones that -- if they say even though it started with sand.

I had a hard time following it. I mean, it was basically just a company sheet that they sent. And you don't really even see it until you get to the last page. Where it says, "Amorphous silicon dioxide (slurry) is precipitated from a reaction of sodium silicate solution with sulfuric acid, da da da da....a byproduct of precipitation of sodium sulfate, the slurry is filtered, the dry product is milled and then it's packaged."

And then it says, we do not intentionally add heavy metals. That's good. Calcium silicate is formed in the reaction. Slurry with synthetic amorphous silica slurry, which is made from mineral alkalized sand and precipitated with mineral acid.

So I still have a hard time wrapping my head around this. But if it's made from sand, what in the manufacturing process would get rid of any crystal structures which is what we are concerned about?

DR. HELDRETH: It's not perfectly clear in my mind but if they're taking a step to precipitate out the product, in all likelihood they're filtering off that residual sand and then -- not crystalizing it but precipitating out the product. So it should not be difficult to prevent the sand from being left over there.

DR. BELSITO: It goes on to say, elemental impurities in calcium silicate originate from the mined sand. And have variation due to natural variation in the sand with specified max-content controls. Whatever that means.

DR. HELDRETH: So, when they're reacting it, then you end up getting the calcium, a cation there. The calcium is coming from their sand, their mined material. And that natural material may not be a hundred percent calcium, but there may be some sodium, there may be some potassium or whatever counter ion may be there.

DR. BELSITO: I mean, I guess the only other issue that I have is that this is data from only one company, Evonik or Evonik or however you want to pronounce it.

DR. EISENMANN: Well, calcium silicate is also a food ingredient. Check the specifications on it. And did you see this SASSI table of other things? This was provided August 15. It's at the back of the -- they have a table and there's another calcium silicate. They don't specifically sell it from cosmetic use, but they give another method of manufacture. And they say crystallinity less than .2 percent.

So this table has calcium silicate, magnesium silicate, sodium silicate from two different suppliers; potassium silicate, and sodium metasilicate.

DR. BELSITO: What page in the PDF are you on, Carol, I'm sorry.

MS. BURNETT: It would be 284.

DR. BELSITO: So, basically the crystallinity at most is less than .2 percent for calcium magnesium, sodium potassium and sodium metasilicate. It's not my area of expertise. Is that low enough that it doesn't become a respiratory issue?

DR. SNYDER: I have no idea.

Synthetic Amorphous Silica and Hydrated Silica – Expert Panel for Cosmetic Ingredient Safety Meeting Transcripts

DR. LIEBLER: I don't have any idea either. My inclination is that those concentrations are low enough not to be of concern. This isn't like a carcinogenicity endpoint. Well, it's not like a mutagen, for example.

DR. BELSITO: Right. It's a clearance issue.

DR. LIEBLER: Yeah.

DR. KLAASSEN: .2 percent is pretty darn low.

DR. LIEBLER: Yeah.

DR. BELSITO: And then what's the highest level in a potentially aerosolized product? This document is too long. Too much discussion too.

DR. HELDRETH: Calcium silicate incidental inhalation-spray is .005. And the incidental inhalation-powder is 5 percent.

DR. BELSITO: So, as a powder it would be five percent with a maximum of .2 percent?

DR. LIEBLER: Yeah.

DR. BELSITO: That would be 1 percent?

DR. LIEBLER: Five percent use concentration, maximum impurity .2 percent.

DR. BELSITO: Yeah.

DR. LIEBLER: .01. So it is very low.

DR. SNYDER: I thought we were under the impression that we weren't dealing with any crystalline or silica.

DR. BELSITO: Well, what they're saying is that these -- are they salts, calcium silicate?

DR. LIEBLER: Yep.

DR. BELSITO: But these salts are basically amorphous silica with metal, calcium, sodium, magnesium, potassium and that they should be included with the safe as used for the amorphous --

DR. LIEBLER: In other words, we had no concern about hydrated silica and silica?

DR. BELSITO: Right.

DR. LIEBLER: Synthetically manufactured. And they're just saying that these other ingredients are sufficiently amorphous and have low enough crystalline. And their crystalline numbers are in the less than one percent range for contamination.

DR. BELSITO: Right.

DR. LIEBLER: And given the mode of action for silica --

DR. BELSITO: Which may also be the same for the --

DR. LIEBLER: Hydrated.

DR. BELSITO: -- hydrated silica.

DR. LIEBLER: I don't know. It may even be less, but I don't know.

DR. BELSITO: Well, because we just saw how -- I mean, I'm assuming amorphous silica is made the same way for calcium silicate as it is for --

DR. SNYDER: Potassium silicate or any of them. Hydrated.

DR. BELSITO: Well, but also for the hydrated silica.

DR. KLAASSEN: You know this data on the crysta- -- what percentage of it is in the crystalline form. It's really not .2 percent; it's less than .2 percent.

DR. BELSITO: Right.

DR. KLAASSEN: So it could be zero.

DR. LIEBLER: But even if it were .2 percent and the use concentration in an inhalable product of calcium silicate is five percent, then it's .2 percent of five percent.

DR. KLAASSEN: Yeah, I'm not concerned. I agree.

DR. LIEBLER: I mean, given the mode of action that we know of these for a respiratory toxicity --

DR. SNYDER: I guess, I'm somewhat confused here. I thought we were talking about the -- one were mined and had this crystalline silica structure issue.

DR. BELSITO: Um hmm.

DR. SNYDER: And we were talking amorphous silica, either the wet or the thermal processed ones that were the synthesized ones.

DR. BELSITO: Right. From silica tetrachloride -- in Figure 1.

DR. SNYDER: Yeah. And they were not -- so crystalline is not an issue. Now all of a sudden we're finding out that some of the amorphous actually are from mined material and they do have crystalline contamination -- so that's a whole different spin than what we were dealing with previously. Is that right?

DR. BELSITO: Right. I mean, that's what they're saying here.

DR. EISENMANN: Well, they suggested you do hydrated silica than silica alone and do the other ones together.

DR. SNYDER: So maybe that makes more sense. Because I think it's really confusing to me now because now it's -- that's the premise I was reviewing the document under.

DR. BELSITO: Right. And now we have --

DR. SNYDER: Now we know that there's crystalline silica. So now I'm trying to scramble back and say, okay, what level do they see effects in animals with crystalline silica causing tumors? I was looking at this data here and it's --

DR. EISENMANN: Well, the data on crystalline silica aren't in the report.

DR. LIEBLER: Right. Yeah. So we don't know at what levels -- I don't know what less than .2 percent means. You have to assume the worst-case scenario, what does .2 percent mean?

DR. BELSITO: Well, but we also know that there is apparently a type of amorphous silica that is produced from mined sand. At least because the report on calcium silica, it says it starts with amorphous silica, but that is derived from mined sand.

MS. BURNETT: And this report is not supposed to have any mined substances.

DR. BELSITO: Right.

DR. LIEBLER: Right.

DR. SNYDER: So we take them out?

DR. BELSITO: I mean, I think we need to. And we need to say that was specifically talking about amorphous silica and hydrated -- or we're talking about hydrated silica that is manufactured starting as shown in Figure 1.

DR. SNYDER: Well, going back to what Carol mentioned, they originally wanted us to separate them out into hydrated --

DR. EISENMANN: Silica and hydrated silica should be a separate report.

DR. BELSITO: Right. We define amorphous silica and hydrated silica as manufactured per Figure 1, starting with silicon tetrachloride and not with any mined materials.

DR. SNYDER: Otherwise, we're going back to square one.

DR. KLAASSEN: Where does this silica and tetrachloride come from?

DR. LIEBLER: It's a precursor for the synthesis of hydrated silica and silica.

DR. KLAASSEN: Yeah, I know, but might have that come from sand?

DR. EISENMANN: It could have.

DR. BELSITO: But it's vapor, so there shouldn't be any particle in the vapor. They start with silicon -- if you look at Figure 1, PDF page 159, the figure says that the starting material is silicon tetrachloride vapor.

DR. SNYDER: So with that, should it all be removed from -- because this report's going to keep moving forward. All that needs to be removed from this report into a new report. And then this report stays as what we originally envisioned.

DR. HELDRETH: At this point, you've already looked at silica, hydrated silica, and all these other silicates. You've asked for a number of data points and got nothing back essentially. Do you really want to look at those other ingredients again in another report?

DR. SNYDER: No, you're right. They're going to be insufficient.

DR. HELDRETH: And wait for no data to come? Or do we just say that they're still insufficient?

DR. EISENMANN: Why are they insufficient? Isn't everything but inhalation? And so say for everything except products that may be inhaled?

DR. HELDRETH: But the insufficiencies were listed, chemical characterization, composition, impurities, method of manufacture.

DR. EISENMANN: But you've got that now.

DR. HELDRETH: The only thing we received was an MSDS on calcium silicate. We didn't receive any of these other endpoints.

DR. SNYDER: Yeah, we don't have any use. We don't have any physical chemical properties, no method of manufacture.

DR. EISENMANN: This table. And there's also some information in Wave 2 on one of the aluminum ones, not the manufacturer.

DR. BELSITO: Yeah, that table.

DR. EISENMANN: So, for the silicates, I'm not sure why you can't say it's safe for the dermal product but not -- if inhalation is your only concern.

DR. SNYDER: I have it as, Crystalline silica and mined silicates are not similar to amorphous silica and require separate reviews. But we don't have any data.

DR. LIEBLER: And the uses on these? Calcium silicate, magnesium silicate, sodium silicate, and potassium silicate, sodium metasilicate.

DR. BELSITO: Where is the cosmetic table? What PDF page?

DR. SNYDER: I'm looking for it right now.

DR. BELSITO: What?

DR. SNYDER: I'm looking. 163.

DR. LIEBLER: Going down. At least it's going down.

DR. BELSITO: And there are a lot of potential respiratory --

DR. SNYDER: Mm-hmm.

DR. EISENMANN: But like for sodium metasilicate the main use is hair coloring.

DR. LIEBLER: And a couple of them have uses increasing actually.

DR. BELSITO: I think that our conclusion is the same as it was before. The only thing that I worry about now is the fact that the --

DR. SNYDER: Premise of the amorphous.

DR. BELSITO: Of amorphous being purely chemically synthesized from the silicon vapor is not necessarily true.

DR. SNYDER: Valid. Um hmm.

DR. LIEBLER: No, I think it is true. The other ingredients that --

Synthetic Amorphous Silica and Hydrated Silica – Expert Panel for Cosmetic Ingredient Safety Meeting Transcripts

DR. BELSITO: No. Dan, if you look at the information I sent us on calcium silicate, it says that the amorphous silica is made from mined sand.

DR. LIEBLER: That's for calcium silicate.

DR. BELSITO: Right.

DR. LIEBLER: That's not silica and hydrated silica.

DR. BELSITO: How do we know?

DR. LIEBLER: Silica and hydrated silica are produced synthetically.

DR. EISENMANN: Well, that's what you're saying that this report is on. It's not on other silicas.

DR. LIEBLER: They've insisted to us repeatedly that hydrated silica and silica are produced -- are amorphous and are produced synthetically. This sodium silver aluminum silicate is from mined silica.

DR. KLAASSEN: Right.

DR. BELSITO: But they say it's -- if you look at the last page here on the letter we got from SASSI --

DR. SNYDER: That we just got two days ago.

DR. LIEBLER: I didn't see that.

MS. BURNETT: We got it on Friday here.

DR. BELSITO: -- it says that the amorphous silicon dioxide slurry -- okay, that's how they're using it. So they're using amorphous silicon dioxide.

DR. SNYDER: It's on the last page.

DR. BELSITO: And then it says that the synthetic amorphous silica slurry, which is made from mineral alkalized sand and precipitated with mineral acid. So apparently, there can be an amorphous silica that is not started with silicon tetrachloride vapor, but with sand.

DR. LIEBLER: Where's the sand?

DR. KLAASSEN: The page before.

DR. BELSITO: Seventeen. The last --

DR. LIEBLER: The last -- I see. The last item. Sorry, I was looking at the scheme above it.

DR. SNYDER: I mean, that's one of the things we asked for, method of manufacture or source of -- and that tells us that the source is from mined material.

DR. BELSITO: Right.

DR. LIEBLER: Potentially.

Synthetic Amorphous Silica and Hydrated Silica – Expert Panel for Cosmetic Ingredient Safety Meeting Transcripts

DR. BELSITO: So apparently you can make them. There are other manufacturing processes for amorphous silica. And what we have proved is, one, where they start with a vapor which shouldn't contain any crystalline structures. But there are others that could potentially contain less than .2 percent crystalline structures.

DR. EISENMANN: But you're saying the material that's described in the report, that's what's safe.

DR. SNYDER: Mm-hmm. Well, not necessarily because if the amor- --

DR. BELSITO: Because if we include this in the report then we're saying there are other ways of manufacturing amorphous silica. Or even beyond that, we now know that there other ways of manufacturing amorphous silica.

DR. SNYDER: Our overarching premise was that amorphous silica was synthesized, it was not from mined material, no potential for crystalline structures. That's no longer the case.

DR. BELSITO: Right.

DR. HELDRETH: Does this description really say that this is not synthetic? I mean, all synthesis has to start from natural elements that we can find here on earth. Even something that we would consider a purely synthetic chemical, a chemist eventually had to pull the starting materials out of some coal or some petroleum distillate of some sort to get started with here.

DR. BELSITO: But then at the end of the report on whatever it is, PDF page 284, we know that these that are started with -- yeah, PDF page 284. That calcium silicate they can contain -- let me rotate this view -- crystallinity less than .2. Which means that it can be .19, we don't know. Or it could be the limits of detection of the method they were using.

Where's that crystallinity coming from? It's coming from the amorphous silica that was produced from mined sand presumably. It wouldn't come from silicon vapor.

DR. LIEBLER: To get to your point, Bart, I normally think of synthetic and synthesized as meaning the method of making the chemical produces the chemical bonds that hold it together. Like you'd certainly think of an organic chemistry synthesis which involves making carbon, carbon bonds. In the case of inorganics like this, making silicon-oxygen bonds.

As opposed to taking a naturally occurring material and preparing something from it. I would not use the term synthesized from sand, for example. I would use the term prepared from sand or purified from sand. And, in some cases, they'd further expose it to some metal ion salt to substitute metal cation in it to make another variant of it. But I'd consider that, again, that's prepared from sand.

One way we can handle this, is we could simply state explicitly in our report that the Panel considered that silicates can be prepared from sand or synthesized de novo. And the Panel, here, is considering the safety of synthesized de novo hydrated silica and silica. And that the panel is not reviewing ingredients that are prepared from sand or other earth materials. Can we do that?

MS. BURNETT: Well, do I need to modify the wording that's already in there?

DR. LIEBLER: The definition? What page, I'm sorry.

MS. BURNETT: PDF page 146.

DR. BELSITO: Where did you put your little insert, Paul? What page was that?

DR. SNYDER: It's on page -- on the intro, page 145.

DR. EISENMANN: There's also a method of manufacture for calcium silicate. It comes from the *Food Chemicals Codex* that says it can be made from diatomaceous earth or precipitated silica.

MS. BURNETT: Diatomaceous earth, that's a report that's coming up, right? Is that me? I don't remember.

DR. SNYDER: See I inserted that. I showed that -- I inserted that. As described in the safety -- or limited method described or something. But the problem is the title gets us in trouble because it's amorphous silica.

MS. BURNETT: And amorph is synthetically derived.

DR. SNYDER: Right. And that encompasses more than what I just read in the report.

DR. LIEBLER: The title can be reworded. The safety assessment of synthetically manufactured amorphous silica and silicates as used in cosmetics.

MS. BURNETT: Did you find -- does this need to be modified then? It's on page 146.

DR. SNYDER: The most important segment is after the list of ingredients where you consider the method of manufacture of the ingredients. Whether synthetic or mined could be of significant importance. That's still true. I mean, that's where we getting --

DR. LIEBLER: So under chemistry definition, the first paragraph on page 146; Christina just pointed out to me that it says, "Thus, the current assessment is exclusive to the ingredients here and when manufactured via synthetic methods."

DR. SNYDER: We know a synthetic method that involves mined sand.

DR. LIEBLER: But we could add another sentence that says that that's not synthesis. Because that's not really synthesis; that's purification, preparation from sand. It's different. In other words, right after that sentence it could say that this definition does not include silicates produced from sand or other natural -- or other, you know, from mined materials.

MS. BURNETT: Can you say that again?

DR. LIEBLER: So this report does not include ingredients produced from mined materials such as sand.

DR. SNYDER: The Panel recognizes that there are other sources that may be from mined materials and those are not included in the safety assessment. Something along that line.

DR. LIEBLER: That's fine.

DR. HELDRETH: So essentially, we're saying that calcium silicate prepared the way presented is not included in this report?

DR. LIEBLER: Right.

DR. EISENMANN: But isn't the concern -- I'm going back to this -- isn't the concern inhalation?

DR. SNYDER: Right. I mean, that gets to the point. We're here to evaluate the safety of ingredients used in cosmetics. And so, if those ingredients are used we should assess the safety of them. And if they're mined --

DR. BELSITO: But Carol's point is can we say that they're safe as long as they're not respirable.

DR. EISENMANN: Right. As long as you don't use it in products that may be inhaled, so it doesn't matter.

Synthetic Amorphous Silica and Hydrated Silica – Expert Panel for Cosmetic Ingredient Safety Meeting Transcripts

DR. SNYDER: But then we have to add in all that data then from the crystalline silica, to know whether .2 percent means anything. I mean, 2.2 percent inhaled over a lifetime may -- I mean, asbestos, you're exposed when you're a teenager and you don't develop cancer until you're in your 70s and 80s. So, I mean, again, I think there's an issue there. I mean, I don't know where it's at, I mean, as far as -- because we weren't considering that in this report before.

DR. LIEBLER: Let's step back and ask Bart. If we don't consider the other silicates, other than the synthetic hydrated silica and silica -- if we don't consider them in this report, did those need to come back in another report? Do those need to get evaluated somehow?

DR. BELSITO: Yeah.

MS. BURNETT: We've already cleaved off half of the report that I originally presented to you anyway. That is supposed to be a mined silica report. So this data from that can go into --

DR. LIEBLER: Into the mined silica -- the mined ingredients basically.

DR. SNYDER: This is sometimes where we get in trouble with two groupings -- too big a group.

DR. LIEBLER: You're saying we get in trouble with groupings that are too --

DR. SNYDER: These are a little onerous, yeah.

DR. LIEBLER: So I think probably our best course is to keep this with the synthetically produced hydrated silica and silica. The other silicates that are mined ingredient origin go together in another report. And then we might have to take the approach that Carol points out of saying, restricting use to products that aren't inhaled; but we'll cross that bridge when we come to it.

DR. EISENMANN: But for these ingredients, you're just going to say --

DR. SNYDER: We still have to deal with the respiratory potential.

DR. LIEBLER: But they don't contain crystalline silica.

DR. EISENMANN: Hardly. I mean, you probably breathe some amount crystalline silica every day, because it's probably in sand particles, or --

DR. SNYDER: Sure. Fine.

DR. EISENMANN: I was just wondering maybe you'd -- Christina, maybe we need to find a review of crystalline silicate inhalation.

DR. BELSITO: The sand we inhale is not refined and is a much larger particulate in size.

DR. LIEBLER: Right. Different ingredient.

DR. SNYDER: Not on my beach.

DR. EISENMANN: Right.

DR. BELSITO: I mean, the issue is, is if we say that amorphous -- or that silica and hydrated silica that is synthetically produced and we -- again, that's subject to interpretation what you mean by synthetically. Is safe, then aren't these salts safe if they're using that silica to produce them?

Synthetic Amorphous Silica and Hydrated Silica – Expert Panel for Cosmetic Ingredient Safety Meeting Transcripts

DR. LIEBLER: I don't think we've had other silica other than hydrated silica and silica. We haven't had any other silicates presented to us as ingredients that are from synthetically produced hydrated silica and silica, then modified with calcium or magnesium or aluminum or whatever. All the calcium and magnesium and aluminum compounds that have been presented to us are from mined materials. I think we're left with silica and hydrated silica when produced synthetically as described, because it is described.

DR. BELSITO: As described in Figure 1 of this report.

DR. LIEBLER: Yeah.

DR. BELSITO: What do we do? And then we just said the rest of these ingredients are insufficient?

DR. LIEBLER: They're not being reviewed.

DR. BELSITO: So we're now creating --

DR. SNYDER: We know that it's insufficient. I think that's a cop-out because they won't be reviewed.

DR. LIEBLER: I thought we had others that have been stripped out of the report.

MS. BURNETT: They're going to be reviewed.

DR. LIEBLER: They're going to be reviewed. Why not put them with those -- all the mined ingredients together and then address them all.

DR. SNYDER: Okay. Okay.

DR. KLAASSEN: I agree.

DR. SNYDER: Okay.

DR. KLAASSEN: Seems most logical.

DR. HELDRETH: So move everything but these two into that other report.

DR. BELSITO: Yeah.

DR. LIEBLER: Everything but these two. Correct.

MS. BURNETT: Okay. So then the conclusion stands for silica and hydrated silica are safe --

DR. BELSITO: When produced as defined in Figure 1.

MS. BURNETT: And formulated to be non-irritating?

DR. BELSITO: Mm-hmm.

MS. BURNETT: When produced.

DR. SNYDER: Sourced as described or something like that.

DR. LIEBLER: So we'll need a Figure 1.

Synthetic Amorphous Silica and Hydrated Silica – Expert Panel for Cosmetic Ingredient Safety Meeting Transcripts

MS. BURNETT: I do have a Figure 1.

DR. LIEBLER: Or am I missing it?

MS. BURNETT: It's all the way on the bottom.

DR. KLAASSEN: It's on page 159.

MS. BURNETT: It's with the tables.

DR. LIEBLER: Oh, it's with the tables themselves. I see. Never mind. Got it. Jim's got this one.

DR. BELSITO: So we're moving all salts into the mined silica report. And in the conclusion, are we stating that when manufactured or are we putting that in the discussion?

MS. BURNETT: Both.

DR. SNYDER: Both. Put it in the introduction.

DR. LIEBLER: I think if we've defined it clearly in the report and explained it in the discussion, I don't think it needs to be part of the conclusion.

DR. BELSITO: So the Panel concluded that silica and hydrated silica are safe in the present practice of use and concentration as described in the safety assessment when formulated to be non-irritating. That's our conclusion because everything else goes away.

DR. SNYDER: Right.

DR. HELDRETH: And then the title need to be --

DR. SNYDER: Yeah.

DR. BELSITO: Synthetically manufactured.

MS. BURNETT: Silica and hydrated silica.

DR. HELDRETH: So amended safety assessment of synthetically manufactured amorphous silica and hydrated silica?

DR. LIEBLER: Yes.

DR. HELDRETH: Okay.

DR. LIEBLER: Because the word silicates will drop out.

DR. HELDRETH: Okay.

DR. BELSITO: Okay. And then we need to stress in the discussion that we became aware that amorphous silica could be produced --

DR. SNYDER: Sourced from mined materials.

DR. BELSITO: -- sourced from mined materials and we're not considering amorphous. We're not considering silica or hydrated silica that is produced from mined materials.

DR. SNYDER: Right. Phew.

DR. BELSITO: Poor Christina.

DR. HELDRETH: I was just thinking about the future of the other silica report. All of these insufficiencies should carry through that these ingredients are shifting over there I would imagine.

DR. BELSITO: Right.

DR. EISENMANN: For the other one, even though crystalline silica -- you'd probably want the data on crystalline silica in the other report, right?

DR. SNYDER: Yes.

DR. EISENMANN: Which is going to be a big effort to do that because that hasn't been done before, it's just been clays and things. I suspect there's some good reviews out there that you could probably just rely on, a few good reviews, if you could find those.

DR. SNYDER: Yeah.

MS. BURNETT: So some of the ingredients that were cleaved off are clay ingredients.

DR. EISENMANN: Correct. But then there will be a whole database on crystalline silica itself which is -- it will be just a small component of the clays and these ingredients.

DR. BELSITO: Okay. Anything else on this?

DR. EISENMANN: So will this go out as another tentative report?

DR. HELDRETH: No, this will go out as a final report for those two ingredients. That conclusion is identical to what it was in the tentative amended report.

MS. BURNETT: Strip out all the silicates.

DR. HELDRETH: Unless the Panel wants to see this again.

DR. BELSITO: No.

MS. BURNETT: I'm not sure I do.

DR. KLAASSEN: You have no choice.

MS. BURNETT: Yeah.

Marks' Team Meeting – September 16, 2019

DR. MARKS: Okay. Next is silica. We have an August 22 memo from Christina entitled the Draft Final Amended Safety Assessment of Amorphous Silica and Synthetically-Manufactured Amorphous Silicates. At the June meeting, the Panel issued a tentative amended report with a conclusion that silica and hydrated silica are safe in the present practices of use and concentration when formulated to be nonirritating.

Synthetic Amorphous Silica and Hydrated Silica – Expert Panel for Cosmetic Ingredient Safety Meeting Transcripts

There was insufficient data that determined the safety of the remaining 22 ingredients. And that's on page 158 to see a list of those ingredients. And this was the one where I was trying to find the minutes from the June 2019 meeting. Are they part of it? Christina, I was trying to find those. I may have overlooked them.

But at any rate, we also received a Wave 2 from the Synthetic Amorphous Silica and Silicate Industry Association dated September 12; and that was in reference particularly to the trade names 035133 and 03600, both are calcium silicate.

Ron and Tom, your comments? The big issue with the silicates, of course, was the potential of inducing silicosis with inhalation of these. Mined silica, you had clarified as to synthetic silica, should be fine from an inhalation point of view if I interpreted correctly.

And then, Ron and Tom, I want you to comment about the inhalation and the discussion that Christina put together. I thought it read well. Is there anybody from this SASSI, the Synthetic Amorphous Silica and Silicate Industry here who wants to comment? No.

MR. GREMILLION: There's also a letter from Women's Voices of the Earth on this.

MS. BURNETT: That was provided in the Wave 2 correspondence.

DR. MARKS: Oh, this.

MR. GREMILLION: For me, I had a link to the letter embedded in my agenda.

MS. BURNETT: Yeah, that's how the correspondence was provided.

DR. SHANK: Me too.

DR. MARKS: Okay.

MS. BURNETT: No, it was August.

MR. GREMILLION: August 28.

DR. MARKS: Okay. Somehow, I missed that.

MS. BURNETT: This is the findings from the last June. If you want to see the transcripts from the June meeting, it starts on page PDF 54.

DR. MARKS: Fifty-four. Yeah, I think when they aren't dated, it's harder for me to look through.

MS. BURNETT: **That's more of a summary. Here it is.**

DR. MARKS: Page 54. Okay. Let's start with the SASSI letter and then we'll get to the Women's Voices for the Earth. Somehow, I overlooked that.

DR. BERGFELD: I didn't see it either.

DR. MARKS: Pardon.

DR. BERGFELD: I didn't see it either.

DR. MARKS: Yeah, okay. So, Ron and Tom, did you see that letter from the Women's Voices of the Earth? And have you seen the SASSI letter?

DR. SHANK: Both.

DR. MARKS: Okay. Ron, maybe you can comment, then, about both letters.

DR. SHANK: Well, I think if we get the information on the physical and chemical characterization of the ingredients -- this has been promised by SASS. And seeing that, maybe we can answer a lot of these questions. So I would say table this until SASS provides the physical/chemical characterization of the ingredients. If nobody agrees with that, then I would approve the report as written.

DR. MARKS: So you don't think we could move forward with a safe for silica and hydrated silica when formulated to be nonirritating; and insufficient for the remaining 22 because of what you said?

DR. SHANK: Correct.

DR. MARKS: You wouldn't even move forward with silica and hydrated silica as being safe from --

DR. SLAGA: Well, until we --

DR. SHANK: Well, silica and hydrated silica are safe -- The conclusion now reads that they are safe.

DR. MARKS: Right.

DR. SHANK: But insufficient data for the others.

DR. MARKS: Yes. That's what we have.

DR. SHANK: But SASSI has said they will provide the rest.

DR. HELDRETH: And they did provide a --

DR. SHANK: There was some --

DR. HELDRETH: A further correspondence of 9/13 for the calcium silicate.

DR. SHANK: Correct.

DR. HELDRETH: It seemed to indicate in the letter that that's all we were getting, like that was the response we were waiting for.

DR. SHANK: They said that's all they're going to do? I thought he said more will follow.

DR. BERGFELD: I thought the letter said more will follow.

DR. HELDRETH: We haven't received anything but this correspondence.

DR. SHANK: Okay. But did they not, in their letter, say that they will supply the rest? Did I read that wrong?

DR. BERGFELD: As it reads, "Dear Dr. Heldreth, as we noted in our August 15 letter, we're committed to providing additional information on several silicates that are manufactured by one of our member companies. Attached are documents covering two products from Evonik Corporation -- the 035133 and the 03600, both calcium silicate -- and a description of the calcium silicate product process.

Synthetic Amorphous Silica and Hydrated Silica – Expert Panel for Cosmetic Ingredient Safety Meeting Transcripts

As in the past, we are open to discussing any opportunity to assist CIR in completing a comprehensive and accurate review of synthetic amorphous silica and silicate ingredients. Please contact me to determine how we can support the efforts of your organization. We look forward to your response." That's it.

DR. MARKS: Yeah, so I think Mr. Pavlich in this letter implies, we're committed to providing additional information, and this is the additional information. I don't expect to see another one after this unless perhaps once this goes out -- I think with this, for me, the question is, is there enough information in this to declare calcium silicate as safe?

MS. BURNETT: I did want to point out just in case the Panel missed it. In the letter that did promise this data back earlier in August, there was a table that gave some of the method of manufacturing data. That information wasn't incorporated in the report because we received it late. But it is in the report package, just in case you missed it. It's on PDF page 284.

DR. SHANK: Two eighty-four?

DR. BERGFELD: It's sideways.

DR. MARKS: So it's that table that has typical particle size? Is that the one with the calcium silicate, magnesium silicate? I guess when I look at that and this report, what struck me is they give a median particle size, so there could be a range.

And, if the median particle size is -- is this adequate in terms of dealing with inhalation toxicity and the same -- I know we've talked about inhalation. We're going to get to it next actually. It's timely. The inhalation -- we call it now a resource document -- where particle size isn't the only thing that determines the safety of an inhaled product.

DR. SHANK: Right. And these are particle sizes for what is supplied to the formulator. This is not the particle size in the product. Is that correct -- I think that's correct.

DR. MARKS: That would make sense to me. Now, I don't know when it's in the product do you get aggregation or whatever.

DR. SHANK: We don't know.

DR. MARKS: I guess the conservative interpretation would be this is the particle size in the product.

DR. SHANK: It wouldn't be any smaller.

DR. MARKS: Correct. Well, except again, as I pointed out, at least in this, I'd say this is a median particle size which would -- I'm looking at the 600 one where the median particle size is 8 micrometers. And then under the 5133, it's 11; so that's median. So is the range, would that be worrisome? Or even is this particle size worrisome? I'm not an inhalation toxicologist.

DR. ANSELL: I don't believe we're trying to model or predict. We have actual inhalation data on amorphous. So the request was method of manufacture, not trying to go back and predict what the inhalation studies would show since we have the inhalation studies already which show these amorphous materials are not hazardous by inhalation. So this is more of a descriptor than intended to go back and predict what the inhalable proportion would be.

DR. MARKS: Maybe my memory is incorrect. I didn't find it in the minutes, I was looking for it. I got the sense that they couldn't confirm, other than silica and hydrated silica, that these other 22 ingredients might have some mined silica in it. Now, did I remember incorrectly, or did I hear that correctly?

DR. ANSELL: No, I think at the meeting it became an issue. But I'm confused as to why we've drawn that line when the line we want to draw is between amorphous and crystalline, not whether it's mined or synthetic. Because

Synthetic Amorphous Silica and Hydrated Silica – Expert Panel for Cosmetic Ingredient Safety Meeting Transcripts

that's not the driver of the toxicity. I mean, with silicates, the dividing line on basis of the toxicity is between amorphous and crystalline; and they behave very, very differently. And we have a pile of inhalation data on amorphous material showing that.

So the table, I think, is sufficient because you asked for manufacturing processes not respirable fractions from the studies, or respirable fraction from cosmetic products to predict what would happen when we don't have predict, we have the actual inhalation studies. Yes, there was a big discussion of that, but I'm confused as to where that arose. I think that arose from the December meeting.

DR. MARKS: No, it has to be the last meeting because we wouldn't have had the other 22 amorphous as insufficient.

DR. HELDRETH: In the section about synthetic and amorphous, I think it was primarily led by the representatives from SASSI. So neither the definitions in the dictionary or much of the information we've gotten tells us whether something is amorphous or not.

However, the folks from SASSI mentioned that for the instances of silica and hydrated silica, as far as they know, those are exclusively made synthetically, and the synthetic processes result in amorphous non-crystalline silica. And so that led to the Panel coming to a consensus that synthetic amorphous should head up the title of this program.

And that's how we've defined these ingredients in this report to only be on those ingredients that were synthetically produced. Because they were the only ones that we could rely on to be amorphous.

DR. ANSELL: To the extent there's some confusion as to whether they're amorphous or crystalline, the answer should be, well, this report only addresses the amorphous.

DR. SHANK: It says it.

DR. ANSELL: Yes, as it says clearly in the title.

DR. MARKS: So, in that case then, all the ingredients in this report would be safe if they're all amorphous synthetically-manufactured silicates. And that's where I was -- as I remember, I was surprised on Day 2, because I thought I heard a statement that they couldn't confirm that these other silicates might not have some mined silicate. I don't know.

That's why I was wondering where the minutes are. I need to go back to page 54 and read it. So, if that's the case, Ron and Tom, are all these safe then?

DR. HELDRETH: And I do believe that's -- I don't know that -- let me back up. I agree, we don't know whether or not all of these silicates are necessarily always produced synthetically, whether or not they're always amorphous. And I believe the Panel's intention was to limit this report only to those ingredients that were synthetic amorphous.

However, this information we just received on the method of manufacture from calcium silicate, if you look at it closely it says they started with mined sodium silicate. So then you have to decide whether or not that applies to the ingredient you're reviewing here or not.

DR. MARKS: That's what I remember from the last time, is this silica and hydrated silica were totally synthetic where these others -- where was that in here because that's key? I was focusing -- oh, okay.

So, if you look at the page that has the production process, right under that, under 17 heavy metals and other metal traces. It says, "The calcium hydroxide slurry with synthetic amorphous silica slurry, which is made from mineral alkalized sand with sodium silicate to precipitate with mineral acids." So made from mineral, like what you said.

Synthetic Amorphous Silica and Hydrated Silica – Expert Panel for Cosmetic Ingredient Safety Meeting Transcripts

MR. GREMILLION: I'm troubled that in the Women's Voices letter she argues that even for the amorphous silica that the particle size can be under ten microns, and so inhalable. And so, what I hear you to be saying there's inhalation data that suggests that's not an issue?

DR. ANSELL: Right, that amorphous silica by installation at very high doses does not cause toxicity. That the toxicity we worry about with silica is, well, uniquely associated with the crystalline material. And that's why we were very careful to draw the distinction, not between mined and synthetic but rather the form; and that this report only addresses those forms.

MR. GREMILLION: And I guess her response to that is the inhalation studies don't mention the particle size of the silica. "My review of the inhalation studies included in the assessment noted two things: first, not a single inhalation study mentioned in the assessment include information on the particle size of the silica the animals inhaled." And so, if there was large particles size then it might not have respiratory effects.

DR. HELDRETH: If my memory serves me right, looking at particle size of the ingredients didn't really parlay into giving us any clue as to what the particle size would be of the final product.

MR. GREMILLION: So, can you get data?

DR. HELDRETH: So instead, what we focused on was the lack or presence thereof of crystallinity. So SASSI provided -- and it's in the report there -- concentrations of crystalline silica that were produced for some of these ingredients like calcium silicate, and showed that it was less than 0.2 percent. And then an ingredient that is, at most, 5 percent of the product, that's a very, very small percent of potential crystals in the final product.

MR. GREMILLION: But there's not data on the particle size of the final products. That's a different -- I guess that's like a proxy for the particle size where there's crystalline. It seems like a different issue.

DR. ANSELL: I'm not sure I agree with them then. I seem to remember a number of these are actually by installation to get the doses high enough to really look at them. But several of them do mention particle size. As I'm looking through here, inhalation; the fifth study, 45 percent of the particles, less than 5; the one, two, three, four, five, six, seven, eighth study, 4 percent at 9, 8.3 percent at 5, et cetera, et cetera; the tenth study, less than a tenth; the eleventh study .5. I mean, so let me see.

Table 6, I don't know where that is in the -- typically they're as sold or they're actually manipulated to be a hundred percent respirable. Because, why would do an inhalation study if the animals can't actually inhale it? So they're artificially manipulated to get the doses. Or alternatively, particularly with the silica studies, they're instilled directly into the lung so that you don't have to worry about generation of the appropriate atmosphere.

So I don't think I agree with the Women's Voices if they're saying that inhalation -- that the particle size is suggesting that the animals were not exposed.

DR. MARKS: I guess the question then would be is if we feel this is all amorphous silica, not crystalline. We assume that, and then we could go to all 22; but I think that was the concern with those other 22 ingredients. So the more conservative approach would be leave the conclusion stand as is. This is actually -- Bart, thank you for reading it in detail. That makes one concerned since it says here that it can be sourced from mineral or natural sources, so that's not synthetic.

Tom, Ron, how do you want to proceed with this? Let the conclusion stand as is? Be more stringent in terms of -- in the discussion we assume that all these are amorphous and therefore are safe, and in all 22. Although, if that's the case then we obviously don't move for a final amended report. We'd have to send it out again because this is not a more restrictive conclusion, but a conclusion adding 22 into the safe column.

DR. SHANK: I would leave the conclusion as it's stated.

DR. MARKS: Yeah, okay. I agree.

DR. SLAGA: Same here.

DR. MARKS: Okay.

DR. BERGFELD: I wonder for clarification -- and I'm not a chemist -- when something is declared amorphous, how tightly bound is it rather than being free to be inhaled?

DR. MARKS: I don't think that's -- I think as Jay has mentioned in the talk, the inhalation studies with that were --

DR. BERGFELD: Installation. They weren't inhaled. Is that what you said? In the studies, there.

DR. ANSELL: Typically. But the studies, although not all of them cite particle size, they all cite the route. And so just scanning through them, most of them were aerosolized in some fashion to generate.

But the conclusion is silica and hydrated silica are safe. And then only the 22 are insufficient.

DR. MARKS: Correct.

DR. ANSELL: And we would like to argue that for the 5 in which we have met the Panel's request for providing information on manufacturing, that those 5 be added to the 2, bringing it up to 7; which would be sodium silver aluminum silicate in the August 2 letter. And then in the August 15 letter adding calcium, magnesium, sodium, potassium, silicates and sodium metasilicate.

DR. HELDRETH: But the information we just got for calcium silicate says that it was manufactured from mined sodium silicate.

DR. ANSELL: Right. But the report doesn't go to source, it goes to form. That's what's driving the toxicology. Not where it's beginning, it's where it ends; whether it ends as a crystalline or amorphous form. And they're telling us they're amorphous; and, if they're not amorphous then they fall outside the conclusion.

So we believe that there's significant inhalation data which shows that the amorphous material is not of concern, which resulted in the Panel's conclusion that silica and hydrated silica are okay.

The other 22, they asked the specific request for manufacturing. The tables provide manufacturing information on the five additional materials; and we would request that those five additional materials have met the Panel's request for additional manufacturing material. If the Panel has additional, additional information, I mean, that's fine. But in terms of where we finished the June meeting, SASSI thinks that they've met your request.

MS. BURNETT: On PDF Page 146, under the definition that we give, the language we use, it indicates that the Panel considered the method of manufacturing of these ingredients, whether synthetic or mined, to be of significant importance to safety. Thus, the current assessment is exclusive to the ingredients here and when manufactured via synthetic methods. The definitions and functions of the amorphous silica and synthetically-manufactured amorphous silicate ingredients including this safety assessment are provided in Table 1.

Would I need to change that language if we're saying that it's okay to use mined starter material?

DR. BERGFELD: Source material, did you say?

MS. BURNETT: Yeah.

DR. HELDRETH: Even the title.

MS. BURNETT: Right.

DR. BERGFELD: Since you have the information, you have to add it somewhere.

MS. BURNETT: Yeah.

DR. BERGFELD: I gather you can say, but the end product is amorphous.

MS. BURNETT: Mm-hmm.

DR. SLAGA: I think the table was taken off.

DR. ANSELL: Yeah.

DR. MARKS: Pardon, Tom.

DR. SLAGA: We took the table off. Ron suggested we table it initially. We eliminated that.

MS. BURNETT: I should also remind the Panel that this report was part of a larger report. Where we already took out the ingredients that we believed to be from mined sources for that to be reviewed at a later time.

DR. SLAGA: That was my recollection.

DR. MARKS: Yes, exactly. Jay, what would your response be if I say, okay, these are -- for example, this calcium silicate. I'll use that one since, somehow, I didn't the Wave whichever data for the other four ingredients you talked about.

But with this one, it clearly states that it can begin with mined material if we don't have specific inhalation toxicity studies like we have for silicates and amorphous silica. Can we say this is safe? I mean, I know you're saying the endpoint is amorphous, but is really the endpoint amorphous if it starts with some crystalline silicate in it?

DR. SHANK: So you limit the qualifier for synthetic amorphous.

DR. SLAGA: Right.

DR. SHANK: So, if it's not synthetic in amorphous, the conclusion doesn't apply.

DR. MARKS: Exactly. And I think the only one that we have that is two criteria are silica and hydrated silica.

DR. HELDRETH: So, since the earlier split that we did with this report was to move everything we thought was mined to the mined report --

DR. MARKS: Correct.

DR. HELDRETH: And now we're getting information that suggests that things like calcium silicate, or some adapted form of a mined silicate, should it be grouped with the mined? And just have a silica/hydrated silica report and a mined report?

DR. MARKS: That's an interesting proposal.

DR. HELDRETH: Because, therein, we'll have to discuss all the issues with crystallinity that we don't have in this report, because we're going for purely amorphous.

Synthetic Amorphous Silica and Hydrated Silica – Expert Panel for Cosmetic Ingredient Safety Meeting Transcripts

DR. ANSELL: So you would draw the line that mined raw materials, which are then synthetically manipulated, are different than a natural --

DR. HELDRETH: We've already drawn that line. If they are mined, they go in the other report.

DR. SLAGA: Yeah.

DR. ANSELL: Because the calcium silicate description here is that you take sodium and calcium sourced in solution --

DR. HELDRETH: So it's a modified mined material; whereas the silicate and hydrated silica, at least according to SASSI, is synthesized de novo. I mean, we're not starting with a mined version of silica and altering it and making silica -- making silicon-oxygen bonds. Not breaking them up and grinding them down and changing the counterion.

DR. MARKS: If we did that, Bart, would it again have to go out or is that a more --

DR. HELDRETH: That's less restrictive. Really, it's the same conclusion that you have. Right now you already have safe for silica and hydrated silica when formulated to be nonirritating.

DR. MARKS: Yep.

DR. HELDRETH: And then your insufficiencies for the other 22 can follow them into the other report. And maybe the understanding of crystallinity in particle sizes would be ameliorated by being part of that other group or not.

DR. MARKS: Christina will love this. Would you even, in this case, include the 22 ingredients in this report and only have 2 ingredients period? So you would have to put insufficient for the remaining 22. They would just move it out of this report.

DR. SLAGA: Make sense.

DR. MARKS: And then Jay will have another shot at it in the future.

DR. ANSELL: No, no. We're parsing this more and more finely. And I think to the extent that the SASSI information was insufficient, I guess a solution to proceed with the silica and hydrated silica -- although there's a hell of a lot of silica data in here which we're relying on --

DR. MARKS: And what do you think the title of that's going to be? Mined silica ingredients? Or crystalline silica ingredients? This is amorphous.

DR. HELDRETH: I think you won't need to have those limiters on the other report.

MS. BURNETT: Or the sourced.

DR. HELDRETH: I think we'll just have silicates, something to that effect. And then the report's going to talk about crystallinity. The report's going to talk about what the issues are with inhalation and those sorts of issues that are associated only with mined or crystals.

DR. MARKS: How about this? We move it to a report entitled non-amorphous and non-synthetically manufactured silicates.

DR. HELDRETH: Well, there may be some instances where some of those are amorphous.

DR. MARKS: Yeah.

DR. HELDRETH: I mean, this one clearly is just amorphous for silica and hydrated silica, if the Panel chooses to go that way. We can decide the title for other one --

DR. ANSELL: Just so I'm clear, we feel that the synthetically manufactured amorphous silica, which is silica and hydrated silica, is fine. But we're not certain that amorphous silica derived from mining -- is not fine?

DR. HELDRETH: Do we have enough data to show that some of that mined material's not left over? And to what concentration do we have to worry about leftover crystalline silica that was mined in the material?

Then we have to understand and have a rationale in the report that explains how much crystalline material is an issue. We don't have that information in this report because we're talking about non-crystalline silica only.

DR. ANSELL: So we're going to drop the stuff about insufficiency?

DR. HELDRETH: Yeah.

DR. MARKS: Correct, because we're going to move all those 22 ingredients to this other report and we'll handle it there.

DR. HELDRETH: Right, those insufficiencies would actually rise there.

DR. MARKS: And then, from what I understand, I can still move that there's a final amended report; that it's safe for silica and hydrated silica when formulated to be nonirritating. And deal with those other 22 ingredients which are mentioned in this memo from Christina, that they will be moved to another silica report. And this conclusion does not need to go back out for public comment. Tom left. Ron, are you okay with that now?

DR. SHANK: Yeah, this can't be handled as a split conclusion? Do we need to put all these others in a separate report?

DR. MARKS: Yeah. I actually like moving it, but I think we can do insufficient. But then we get back to Jay's issue of -- and what you mentioned, Bart, is if it has any mined material in it -- I mean, which would imply crystalline silica -- then it's insufficient.

And it sounds like the only way we're going to know is either we know how much crystalline silica is in it, or else we have the inhalation study that say. You know, if they had sent the calcium silicate with an inhalation study showing that it was safe, then it would be easy. Tom, do you have a preference for insufficient versus moving the remaining 22?

DR. SLAGA: Well, what I worry about is that we would get the other document, we'll say, we'll move those 22 out again. Actually, I thought this was going to be an easy one based on our conclusion from the last meeting and I just got confused. I think several of us --

DR. MARKS: First of all, I didn't know there were four other ingredients. I wasn't sure how easy it was going to be with this. And then when Bart astutely pointed out that the base material of this can come from mined silica, then we've got problems, I think.

DR. SLAGA: The problem we have is we wouldn't be able to define how much impurity of crystalline would be in it.

DR. MARKS: Do you have a preference? Obviously, Ron, it sounds like you feel as keep it insufficient for the 22 and then see what comes in the future.

DR. SHANK: Right.

DR. SLAGA: Yeah. I would go with that too instead of moving it, then we would move it back, I worry about that.

DR. MARKS: Okay.

DR. ANSELL: So we're not going to move it?

DR. MARKS: That's where we are now. And then you're going to petition for -- I wouldn't petition for calcium silicate because those other four you mentioned, Jay -- and I didn't write them down -- do we know for sure? Because that's -- again, I need to look at the minutes.

DR. ANSELL: Well, we've got potassium silicate. We've got hydrated, hydrated, hydrated; aluminum silicate, nontoxic; potassium silicate, greater than 5000 milligrams; sodium silicate; hydrated, hydrated, hydrated; hydrophobic.

I could see recycling this because I think we have answered the questions, but we have new questions. I think that's fine for the Panel to pose new questions and give industry an opportunity to respond to them.

DR. MARKS: Yeah, okay.

DR. ANSELL: I would hate to -- yeah, that would be fine. But let's be specific as to what additional information we want, which I think is -- I'm just not sure what it is we want now.

DR. MARKS: Chemical characterization; composition and impurities. And in fact, the impurities would be how much crystalline is in it. And method of manufacturing and source data.

DR. ANSELL: To address the crystallinity or the --

DR. MARKS: Or lack of crystallinity.

DR. ANSELL: Yeah, I'm not sure what the --

MR. GREMILLION: And so, we're not worried about -- just to clarify for the amorphous -- or for the non-crystalline silica, the particle size isn't a concern?

DR. MARKS: No. That's how I understand. Ron, is that correct?

DR. SLAGA: Yeah.

DR. MARKS: We had the -- most importantly we had the --

DR. SHANK: Yeah.

MR. GREMILLION: It would be a hundred percent under ten microns, yeah.

DR. MARKS: Most importantly, we had the inhalation tox data to support its safety.

MS. BURNETT: So, if you are not changing the conclusion, and if the data needs are not really any different than they were before, this is a final report out of this meeting?

DR. MARKS: Correct.

DR. ANSELL: No, they are different. You asked for manufacture and we gave it. Now the question is the crystallinity -- to what extent does the mined material -- is that --

DR. HELDRETH: They asked for chemical characterization, specifically structure; in therein I'm pretty sure they meant crystallinity. And some of the method of manufacture that was given made it more confusing, because some of it showed that it was from mined materials. Are the insufficiencies any different?

DR. MARKS: I think the only thing we could put in when we're talking about chemical characterization and method of manufacture -- and I think it's very important to be certain that it's clear what we're concerned about is the crystalline and that could be -- I mean, the needs are the same, but it's really what you said, Bart, relevant to the crystalline.

DR. HELDRETH: As Christina was saying, this would go final. This would be done. This wouldn't come back around for another bite.

DR. MARKS: Yep.

DR. SHANK: Aren't we limiting it specifically to synthetic amorphous? What's the point here? Why do we have to keep saying, not mined, not crystalline. We say it once at the beginning.

DR. MARKS: For me, the important thing is when we ask for these needs here, I think reemphasizing that it's crystalline that we're concerned about. And we found that like with this document, that it comes from a mined source. I think repeating it in the discussion is not a -- for me, is not a big thing. But you think the title --

DR. SHANK: Okay. But how about the conclusion?

DR. MARKS: I think the conclusion -- are you going back to say, since our title limits to amorphous and synthetically-manufactured, that if one of these other 22 come from something other than amorphous and synthetic, they would be excluded? Or do you still like the conclusion insufficient for the remaining 22? I thought that's where we had landed.

DR. SHANK: Insufficient, yes. But, in the data needs, are we really changing what we're asking for?

DR. MARKS: No. Is that okay with you, Ron?

DR. SHANK: Yes.

MS. BURNETT: Since this data will have to be included in this report, we'll have to expand the discussion somehow to note that the data we received shows that there's mined silica going into a product, correct? The Panel will have to explain.

DR. MARKS: Well, we said that's insufficient so I think that covers it.

DR. HELDRETH: I think what Christina's asking is for her discussion section that she writes for the final report that will go out; what does the Panel say about this data that we received, on method of manufacturing, that does not meet their initial data request?

DR. BERGFELD: It identified crystalline whereas, this does not include crystalline ingredients. Easy. That's why you're moving it.

DR. MARKS: Tom, that was the kiss of death. You thought this was going to be easy. Any other comments?

So tomorrow I'm going to move we issue a final report, safe for silica and hydrated silica when formulated to be nonirritating. It's insufficient for the remaining 22 ingredients. I'm not going to move that we take those 22 ingredients and put them in this subsequent silica report. You're going to be tired of silica, Christina, if you got the rest.

And I expect this discussion's not going to end. And the main concern relevant to the needs is that there's concern that mined silica impurity may be in the remaining; and now we know that it probably is since one of them says it comes from mined silica and that there may be crystalline silica. Does that summarize things?

DR. SHANK: Yes.

DR. MARKS: Okay. Let me save this.

Full Panel Meeting – September 17, 2019

DR. MARKS: At the June meeting this year, the panel issued a tentative amended report for public comment, with a conclusion that silica and hydrated silica are safe in the present practice of use and concentration when formulated to be non-irritating. The panel determined that there was insufficient data to determine the safety of the remaining 22 ingredients.

Our team moves that a final amended report be issued with that conclusion, safe for silica and hydrated silica formulated to be non-irritating. Insufficient for the remaining 22 ingredients.

The concern is that even though the title has amorphous and synthetically manufactured, there are indications from Wave 2 that at least some of these 22 other ingredients in the report may have started from or have part of crystalline mined silica, which we did not feel was safe. And so, the needs remain the same for those 22, chemical characterization, composition, impurities and method of manufacture.

DR. BERGFELD: Comment or second?

DR. BELSITO: Seconded, with comments. We also learned from that report that it appears that some amorphous silica could actually be made by using sand. And we are concerned about contamination of crystalline materials in what appears to be amorphous silica, based on the information we got on calcium silicate.

So, a couple of things; one, we thought that the title should be changed to “Amended Safety Assessment of Synthetically-Manufactured Amorphous Silica and Amorphous Silicates.” Agree that the silicates would all be insufficient. And that it be stressed that the method of synthetically manufacturing the amorphous silica be as diagramed in Figure 1.

It doesn't have to be in the conclusion, but it should be sort of strongly stated in the discussion; that that is the amorphous silica that we're talking about, that's derived from silicon tetraoxide gas, and not any amorphous silica that's derived from sand.

DR. BERGFELD: Comment, Dr. Marks?

DR. MARKS: Our team concurs.

DR. BERGFELD: Any other comments regarding this ingredient? Tom?

MR. GREMILLION: I just wanted to ask about the Women Voices for the Earth letter, and this assertion that the inhalation studies are incomplete. And yesterday we talked about this and Dr. Ansell indicated he thought the letter was off-base; and that the particle sizes that are used in inhalation studies would necessarily be really small.

But I guess I wanted to ask the panel if that was their understanding. And their response to the other assertion that there's not enough support for the idea that the silica will aggregate -- the particles will be aggregated and not pose an inhalation hazard. And there are a couple of references to that idea in this report.

DR. BERGFELD: Anyone wish to comment on that, the inhalation of the amorphous silica? Ron?

DR. SHANK: When you do an inhalation toxicology study, you make sure the particle sizes are respirable. So, I don't think it's an issue in the data we have on inhalation toxicology.

DR. BERGFELD: Curt?

DR. KLAASSEN: Yes, I'm satisfied with what we have here. I think, you know, the studies were done appropriately. And I'm happy with it, so I don't think we need to get more here.

DR. BERGFELD: Okay. Tom?

DR. SLAGA: Yes, I think the data looks very good and I think it shows that it's not a concern.

DR. BERGFELD: Paul, any comment on that?

DR. SNYDER: But, I mean, I think we discussed the fact that you can size these particles so that they can be respirable under experimental conditions. But under the conditions of use as in cosmetics they're not. So, you can see experiments where they've sized particles to force them down into the lung but that's not what we're looking at in terms of a cosmetic product.

MR. GREMILLION: And in terms of this report, it doesn't say like formulated to be above a certain particle size. We're looking to the inhalation resource document for that kind of direction or are either of those kind of addressing that.

Is that something that -- from the letter, she raises this issue that the particle sizes are really small, and people are going to breathe them in. And there's nothing in here that says, you know, formulated to have large particle sizes.

DR. BERGFELD: Or non-respirable.

MR. GREMILLION: Yeah, or non-respirable. And is the boilerplate doing the work on that end, or is that just kind of understood?

DR. BELSITO: The boilerplate is doing the work on that end, giving us the range of sizes that we would expect from pumps and sprays.

DR. ANSELL: I will point out that there are over 30 inhalation studies within the report. Many of which have characterized the particle size, which failed to demonstrate that there's any real concern.

I think putting in particle sizes of restrictions for the synthetic amorphous materials would be unnecessary. We're not trying to address a potential concern; we in fact have substantive data arguing that.

I would, however, like to swing back on this question of the five materials. So the proposal is to go safe for synthetic amorphous silica and hydrated silica?

DR. BELSITO: Yes.

DR. ANSELL: I'm uncertain to what we're doing with the amorphous silica.

DR. BELSITO: We had suggested moving them over to the other group that Christina's putting together.

DR. ANSELL: And we would strongly support that. We think that there's a lot of inhalation data concerning both amorphous and crystalline.

Synthetic Amorphous Silica and Hydrated Silica – Expert Panel for Cosmetic Ingredient Safety Meeting Transcripts

To the extent that there remains a concern that the amorphous may contain some percent of silica or some percent of crystalline, we'd like an opportunity to have the manufactures address whether, in fact, materials contain amorphous which have significant inhalation data showing no concern, might be a concern because of traces of crystalline materials. So, we would strongly support separating those out to address questions which we do not believe were clearly stated in the previous rounds.

DR. BELSITO: That was my second comment, that all of the salts should be moved over to the mined silicate report.

DR. ANSELL: And we would strongly support that.

DR. BERGFELD: I think that was Jim's too.

DR. MARKS: Well, we had discussed that. And I can certainly change the motion, that a final amended report be issued safe for silica and hydrated silica formulated to be non-irritating, and that's the end of the conclusion. The remaining 22 ingredients would be moved to the next report on silica.

And our team is fine with that. We debated that and decided to go with the original conclusion from the last meeting; but we're perfectly happy of moving those 22.

DR. BERGFELD: I see a nod of the head from Don, so that's a friendly amendment of the motion. Thank you. Well then if there are no other comments I'm going to call the question up -- yes? Go ahead.

MS. BURNETT: May I ask. As the discussion is currently written, if you removed those 22 ingredients the discussion becomes a little thin. Is there any more discussion you'd like to put in, just the inhalation boilerplate perhaps?

DR. BELSITO: And the fact that we are under the assumption that the amorphous and hydrated amorphous silica are manufactured synthetically as in Diagram 1, and not from a mined sand.

MS. BURNETT: Okay.

DR. BERGFELD: Any other comments?

DR. MARKS: Yes. Bart I'll ask, may we move on to a final report restricting it to just those two ingredients and eliminating the other 22?

DR. HELDRETH: Yes, that's fine. I do suggest we give Christina a new title, though, because the current title includes the silicates.

DR. BELSITO: Right, we got rid of silicates; and as I said, we say synthetically before we say the amorphous silica.

MS. BURNETT: So, it would be the "Amended Safety Assessment of Synthetically-Manufactured Amorphous Silica and Hydrated Silica".

DR. BELSITO: Correct.

DR. SADRIEH: I just had a general question. Is the methodology for the determination of crystalline silica -- in samples. Is the methodology validated and accepted widely enough in terms of how one would determine the presence of crystalline silica and quantitate the levels. And what would be an acceptable amount if it were to be detected?

DR. BERGFELD: Anyone like to answer that? Ron?

DR. SHANK: Well -- the acceptable amount would be studies which would show a certain level where there was a no-adverse-effect-level from the presence of those causing any lung lesions in an animal study.

So, if there was .1 percent contamination of crystalline in aggregate studies and there were no adverse effects in studies that were -- or powered right scientifically sound studies, then we might accept a certain level of that. But, at this point our premise is we're accepting none.

DR. BERGFELD: Any other comments and responses?

MR. GREMILLION: I hate to beat a dead horse. But what I understood just now is that the inhalation studies show that even if this was milled to be 100 percent particles that are under 10 microns, there wouldn't be an inhalation risk and you'd be saying safe as use. I mean, is that the case? Or is this -- when you say aggregation of silica and hydrated silica -- well, whatever it'll be -- in cosmetic formulations reduces potential inhalation exposure. And that sounds like a directive to, you know, be careful to let this process go on.

DR. SNYDER: I hate to speak for Don or Mark; but, I mean, our premise of all of our reports, as used in this report. And so, in this report we review data that said that they are formulated to aggregate and to minimize the small particle size.

If someone was to make a final product that had less than 10 microns, so that would be not consistent with this report, because that's not how it's used in this report. That's not how they're formulated and how we looked at them.

MR. GREMILLION: Okay. So I guess what she's saying in the letter then is that some of the uses weren't considered in the report; when she talks about the airbrushes and the YouTube video of the women putting on face makeup.

DR. BERGFELD: Well, thank you. Can we move to the question then? All those in favor of this final report, safe? Thank you.

DECEMBER 2019 PANEL MEETING – GROUPING STRATEGY

Belsito's Team – December 9, 2019

DR. BELSITO: Okay. So, we're going to the silicates and whether we were -- this is also in Admin, whether we're happy with how things were broken down here. As you remember, there was the amorphous and now we're into the mined. I guess the questions I had all were to Dan, and anyone else who can explain why calcium silicate is okay, but calcium magnesium silicate got struck.

DR. LIEBLER: Yeah, that was the question I had.

DR. BELSITO: Sodium magnesium aluminum silicate got struck. It didn't really seem to me that these were so different.

DR. LIEBLER: Yeah, I had the same question. I don't know.

MS. BURNETT: We can add them back in. It was just that they were suggested add-ons. And since the add-ons kind of caused a quagmire, we thought, well these are no-brainers, so we pulled all of them out. But we can easily add back in whatever ones you want added in.

DR. BELSITO: But how is lithium magnesium silicate a no-brainer, and calcium magnesium silicate is not a no-brainer?

MS. BURNETT: Those were reviewed originally. So, those were part of the re-review that we reopened, so they already have a conclusion. So we still --

DR. BELSITO: I understand. But if we're looking at them, and now we've all of a sudden gotten concerned about inhalation, da, da, da, da, how is calcium -- I mean, I would be more concerned about lithium magnesium sulfate silicate than I would about calcium magnesium silicate.

DR. LIEBLER: So, these strike-outs are basically not because of some inside knowledge of chemical distinct likelihood of being problems, but they're simply because they weren't previously reviewed, and we didn't want to add them in?

MS. BURNETT: Yes.

DR. LIEBLER: Okay. I think that I --

MS. BURNETT: If you want to keep them all in, we can.

DR. LIEBLER: Right. I agree. I think we can keep them all in, and I like the three-report strategy.

MS. BURNETT: Okay.

DR. BELSITO: Okay. So, you're happy with what's under silicates, Dan?

DR. LIEBLER: Yes sir.

DR. BELSITO: Okay.

MS. BURNETT: What about the clays --

DR. BELSITO: Yes, private. What about clays?

DR. LIEBLER: Yes.

DR. BELSITO: Okay. And zeolites?

DR. EISENMANN: One comment on clays, is there's an ingredient in the dictionary called clay that was 100 uses. And there are also a bunch of site-specific clays that I think you should ignore. But the one ingredient that is called clay --

DR. LIEBLER: I think the issue before us right now is the three-report strategy or something else.

DR. EISENMANN: Okay.

DR. LIEBLER: So, I like the three-report strategy and if anybody doesn't, I'll see them out back.

DR. BELSITO: Oooh, okay.

DR. LIEBLER: But anyway, I mean, think that's fine. And then we can finesse the individual ingredients as we get through these reports.

DR. BELSITO: Okay. Good.

MS. BURNETT: And keep all zeolites, then, too?

Synthetic Amorphous Silica and Hydrated Silica – Expert Panel for Cosmetic Ingredient Safety Meeting Transcripts

DR. BELSITO: Yeah.

DR. LIEBLER: Yeah.

DR. BELSITO: Okay.

DR. BERGFELD: I'm confused about the three-report strategy. You're going to have three more reports?

DR. LIEBLER: Three different reports, instead of having all these grouped together. There will be a report on silicates and a report on clays and a report on zeolites.

DR. BERGFELD: So, you're not accepting this?

DR. LIEBLER: That is what's proposed.

DR. BELSITO: We are. What we're saying is, that they were striking out ingredients that had not been reviewed and just keeping in those that were reviewed. And we're saying, no, if they're in the dictionary, let's put them all in and see where it falls, because Dan feels he can potentially read across. I mean, it's again, to get rid of calcium magnesium silicate, and keep in lithium magnesium silicate, that would make no sense to me.

MS. FIUME: So, it's just the difference of an add-on versus an existing ingredient?

DR. BELSITO: So, are we going to take these up all at one time then?

DR. BELSITO: Right. I understand. But it looks silly.

MS. FIUME: Yeah. Okay.

DR. SNYDER: Well, they're basically already written; they just got to par out the data, pretty much, right?

DR. BELSITO: Right. Yeah.

MS. BURNETT: I'll do another search to make sure there is --

DR. BELSITO: Right. Nothing new.

MS. FIUME: So, we're not going to approve this, we're just going to bring this back the three --

DR. BELSITO: No, just before Christina wasted her time putting them together, are we happy with this way of separating them?

DR. KLAASSEN: Yes.

DR. BELSITO: We're saying we are. Okay.

Marks' Team – December 9, 2019

DR. MARKS: Silicates. Let me see, where is that? Is that in the Admin too?

DR. PETERSON: Yep.

DR. HELDRETH: Yes, it is. PDF Page 61.

DR. MARKS: Oh, good. Thank you. I shouldn't have gotten ahold of the admin folder so quickly. So that's on Page 61 of the admin folder.

And the big toxicity concern was inhalation silicosis, and that's from mined silicates. So, the reason at the June meeting this year -- Lisa, I don't know how much of this you got from this memo in looking back.

But in June of this year, the panel issued a final safety assessment of synthetically manufactured amorphous silica and hydrated silica are safe when formulated to be nonirritating. And we were reassured with that, that there was no evidence of inhalation toxicity by those two ingredients.

And then we were going to have these other silicate ingredients included, but then it became evident that part of them, potentially, could be, mined. And then, now, we were in the inhalation toxicity issue. So, then, there was a suggestion that we divide these in three groups.

And I think also -- let's see in your memo, Christina. Did it say constitute impurities -- so, first was, do you like these three groups? And I guess, do we really need three separate safety assessments, or can we have one safety assessment which has these three groups in it?

So, the first question is, do you like the three groups? I don't think we have anything more than making an assessment. Do we like the groups?

DR. SLAGA: I like them, but I wouldn't put them in one report.

DR. MARKS: Okay. Yeah, I think that's important.

DR. SHANK: The three groups are fine with me. I leave that to the chemists. And if there are one report or three, it doesn't matter to me.

DR. MARKS: Lisa, you're the chemist. Ron is now really putting you on the spot.

DR. PETERSON: Yeah, I thought that they were fine. The three groups were fine.

What I didn't understand was why, like, zirconium silicate was included when it was no longer used; in that it's because there's safety issues associated with that?

And then there's one that was still in use, the -- I think it's -- I'm still learning how to notate in the PDF file, but the ammonium silver zinc aluminum silicate was still in use, so why was it crossed out?

MS. BURNETT: So, for our history, the ingredients that are not crossed out in those lists were already reviewed by the panel. So, back in June 2018, the re-review came up and we proposed these add-on ingredients, which are the red cross-outs. And we reopened the report to add all these ingredients in.

And then, through the process, we've determined that these reports weren't as no-brainers as we usually go for add-ons, so we're proposing to remove them. So, all the ingredients that are in black, without the strikeout, were reviewed in the same report and have the same safety conclusion.

DR. PETERSON: Okay.

MS. BURNETT: Now, the Panel does not have to remove those ingredients. If you feel that they all should be still reviewed together, we can still go ahead with our review. Some of them may be closer in similarity than some of the others, but it's up to you guys to determine whether they should be removed or added.

It just was our suggestion that, oh, maybe these weren't no-brainers after all. We still have to go forward with the re-review process, because these are now hanging out there. So, it's up to you.

DR. HELDRETH: Yeah, we used the frequency of use and concentration of use to inform us on which previously unreviewed ingredients to pick and look at. But for those ingredients we've reviewed before, whether or not there's reported use for them is somewhat inconsequential when we're doing a re-review, which is what we're doing here.

The Panel's looked at them before. It's now been at least 15 years since the Panel's looked at it, and it's time to take another look at it and say, has the science changed? Has the concentration of use changed, the frequency of use changed, and do we need to come up with a new conclusion or not?

So, that's why those ones, like the zirconium silicate, that you pointed out, remain in our list here because they're due for re-review, even though they may not be reported to be in use at this point.

Synthetic Amorphous Silica and Hydrated Silica – Expert Panel for Cosmetic Ingredient Safety Meeting Transcripts

DR. MARKS: So, instead of Freudian slip, Christina, in that last sentence right above the three groups of silicates, “CIR staff suggested that the remaining ingredients be presented.” Because that was the big issue was, when we got the composition at least, Lisa, the representatives from the amorphous silica industry -- SASSI, I think it was, so whatever that is -- that they couldn’t tell us with a surety that these didn’t have mined silica in them, as part of their composition.

So, I think they have to be reopened just for that issue alone. It’s already reopened. But the ones that are in red and you crossed out, if they’re similar ingredients, is there a reason not to include those from a --

DR. HELDRETH: Those were proposed add-ons that we made.

DR. MARKS: Yeah, now it says the remaining ingredients be presented in three separate reports. Yeah. Okay.

DR. HELDRETH: And so, we proposed taking them out just because it seems like it’s been so arduous to try to finish these re-reviews. So, we’ve tried to simplify it, and take it down just to those ingredients that we really had to take a look at.

DR. MARKS: Hm. Oh, I understand the reasoning.

DR. HELDRETH: So, it was just a matter of trying to make this as simple as possible because it’s been an ordeal. You know? And we’ve even brought in -- like you said, even the SASSI folks have come in and are still confused as to which goes with which. That’s why we --

MS. BURNETT: I mean, certainly we could keep them in. I mean, I’ve done an initial search and I will do another search and see if there’s anything new.

So, it’s totally up to you. If you think it’s going to cause more headache, then we can take them out. If you think that we’ve already gone through the headache, we can just pop a couple aspirins and keep going.

DR. MARKS: Well, I don’t -- Ron and Tom? Was there anything when we looked at these before other than really in the inhalation issue and silicosis?

DR. SHANK: That was all. That was all we had.

DR. MARKS: And it’s going to be interesting, because I think, ultimately, it’s going to be an insufficient data -- or insufficient because we won’t be able to get the composition, probably with a surety, that there’s no mined silica. If we got that, I think we could move forward in any and all of these. Is my interpretation correct?

DR. SHANK: You could say safe as used if there’s no mined product.

DR. MARKS: Yeah, there you go. So, you see how we word it around? And that’s -- why didn’t I think of that? But I was only thinking off the top of my head. Exactly.

DR. ANSELL: Isn’t that where we divided this into three groups? Because, each silicate group, we have expansive inhalation toxicology and were prepared to move them forward; but not so for -- but we’re uncertain about some of the other groups?

DR. MARKS: Okay, Jay. So, which group do you think -- do we have enough inhalation tox we can say that by reading across -- I think, whether we put that in the conclusion, Ron, or not, it will certainly be in the discussion in great detail.

So, we’ll be looking at this again with -- but that’s a good point you bring up. Obviously, it’s back to our -- the data is what we want first. And if we have inhalation data that suggests in the present use and concentration, it’s safe, then mined becomes almost a new subject.

Is there anything more, Christina, you wanted from us other than moving that the three groups are okay and to proceed? And I would say include everything you have here, even the red, and then sort it out later.

DR. PETERSON: Yeah, I guess that makes sense to me, too.

DR. MARKS: Does that sound good, Lisa?

DR. PETERSON: Yeah, I got very confused by the “no brainer” statement, and then why some things were crossed out and some things weren’t.

MS. BURNETT: Yeah.

DR. PETERSON: I tried to figure it out, and I couldn't.

MS. BURNETT: Sorry.

DR. ANSELL: Only because it is confusing.

DR. PETERSON: Yes.

DR. MARKS: Okay.

DR. HELDRETH: Yeah. Just for Dr. Peterson's benefit -- so, when we use that phrase "no brainer," that's something that the Panel has kind of used as a measurement for when we do a re-review document and we consider adding in additional ingredients that weren't reviewed before. And the idea being that the data already in the current report would support the safety of those add-ons, even if we never got any data about those new ones.

So, that's the idea here is --

DR. SHANK: No brainer.

DR. HELDRETH: -- do we know that these -- or do we think -- does the Panel think -- I'm sorry -- that these are no brainers? Are they so similar to the ingredients in the current report that we don't need new data to call them safe or have the same conclusion?

DR. PETERSON: Okay, I understand.

DR. HELDRETH: So, that's the idea behind that.

DR. ANSELL: And we fully support that approach. But if you put in an ingredient and then have to reopen the report, because you can't decide whether that ingredient is safe or not, then it falls outside of what we would consider to be a no brainer. So, it has to slip in -- all the data in the current report has to fully support the safety of the add-ins.

DR. HELDRETH: Right. So that's part of the reason why when -- it fell back to CIR staff to come up with groups. That's why we suggested removing these ones, because it's still completely and utterly unclear which ones of these ingredients are synthetic amorphous and which ones are potentially mined.

And we remember back when we looked at the hydrated silica and -- hydrated silica. They suggested to us that it was synthetic. But then you read the details of the synthesis, and the first step is, it's a mined silica and then chemically modified. Not exactly de novo synthesis; and there is potential for having crystalline silica.

DR. ANSELL: Right.

DR. HELDRETH: So, we don't know for any of these. Is the cosmetic ingredient only amorphous? Does it have some crystalline potentially? Is it potentially mined, we don't know. And that's why we suggested deleting any potential add-ons, because we don't know anything about those ones either.

DR. MARKS: Well, I think the conclusion's going to be the same for all of them. And that uncertainty is going to lead us to either an insufficient conclusion or a conclusion, safe as long as it contains no mined silica or crystalline silica.

And that's another way of -- unless, Jay, you have the inhalation toxicity studies on individual ingredients here that would support its safety.

DR. ANSELL: Well, yes. The presence of crystalline silica is a real issue.

DR. MARKS: Yeah.

DR. ANSELL: And that's why we fully support the separation of these.

DR. SLAGA: That's why I think they should be in separate reports.

DR. ANSELL: Right.

DR. SLAGA: I don't like to mix strong against safe.

DR. MARKS: Pardon?

Synthetic Amorphous Silica and Hydrated Silica – Expert Panel for Cosmetic Ingredient Safety Meeting Transcripts

DR. SLAGA: I don't like to mix something that has really potential health problems with something that is safe. That kind of dilutes the safe.

DR. MARKS: Well, that's why we split out in silica and hydrolyzed. But do you want to, right now, go to three separate reports? Or you want to kind of move forward and then let's see what it comes down to with --

DR. SLAGA: Let's see what it comes down to.

DR. MARKS: Okay. Is that okay, Ron?

DR. SHANK: Yes.

DR. MARKS: And Lisa, okay with you? Okay. So, move three groups okay, one report, include all the ingredients including the add-ons. And then we'll see where we go.

MS. BURNETT: And you said separate reports or one?

DR. MARKS: No. One report at this point.

MS. BURNETT: Okay.

DR. MARKS: We don't care.

DR. HELDRETH: I think, separation within the report.

DR. MARKS: Oh, yeah. Absolutely. To me, it just makes it easier in some ways if it's all grouped together.

DR. SLAGA: It makes it easy. Right. It does.

DR. MARKS: Oh, listen.

DR. SLAGA: Yeah.

DR. MARKS: Christina's fine, if she can get through citrus. This is a piece of cake compared to citrus and all that stuff, huh?

MS. BURNETT: Yeah.

DR. MARKS: Okay. Any other comments? So, I'll move three groups are fine, one report at this stage. Include all the ingredients including the add-ons, and then we'll see where we go from there. Okay. Let me save this. So, we'll see what the Belsito team thinks tomorrow. Okay.

DR. HELDRETH: One more thing on this one.

DR. MARKS: Sure.

DR. HELDRETH: I think industry had suggested, if we were keeping any of the stuff in clay groups, that we actually review the ingredient clay since some of these things, like hectorite or whatever, are just subgroups of that one in there.

Should we go ahead and throw that one in there since we're going to be reviewing all these clays anyway?

DR. MARKS: I think that's fine.

DR. SHANK: Okay.

DR. MARKS: Let's include it now, and we could always -- I guess part of that is thinking of you, Christina. If we throw clay in there, does that add a lot more work for you? Although, if it's a safety concern, work is not the issue.

MS. BURNETT: It won't be a problem. I'm more worried about generic searches and --

DR. MARKS: On clay?

MS. BURNETT: Yeah. But we'll figure it out. It's got to be done at some point, so why not now?

DR. MARKS: Yeah. Okay.

DR. HELDRETH: Thank you.

DR. MARKS: Maybe adding clay, Tom, will then force us to go into three groups. Clay will be too big. Okay.

Full Panel Meeting – December 10, 2019

DR. MARKS: So, this is on Page 61 of the Admin folder. And, what is being proposed is that we have three groupings of the silicate ingredients. As you recall, in the September meeting a final safety assessment of synthetically manufactured amorphous silica and hydrated silica are safe when formulated to be non-irritating.

The other silicate ingredients, we were concerned about chemical characterization, method of manufacturing, source if mined and whether it's amorphous or not. And that all led to obviously the potential toxic inhalation effect of the silicosis.

So, we have already opened these ingredients. Christina listed them under the group, silicates, clays and zeolites, and we concur with that grouping.

There was a discussion whether or not to add the proposed ingredients, they were in red and crossed out. We liked adding them since we're going to look at these different groups.

And then there was a discussion as to whether or not -- so we liked the three groups; do we do one report or multiple reports? And we fell on the side of doing one report just divided in the three sections, but that's not a hard and fast.

DR. BERGFELD: Belsito response?

DR. BELSITO: Well, we liked the groupings. We agree not to include those that were suggested to be eliminated. We didn't see the reason for eliminating them.

We did not specifically discuss the issue of putting them into one report and three separate headings. But just thinking about how mind-boggling this is going to be, I would prefer to have three separate reports, personally.

DR. LIEBLER: If we have one report we'd effectively be converting silicates to algae.

DR. MARKS: I've likened it to citrus. Christina, she did such a good job with citrus, I figure she could have handled it.

DR. LIEBLER: We've been there and done that.

DR. MARKS: Yeah, as I said, we didn't have any strong feelings one way or another, so separate reports are fine with our team.

DR. BERGFELD: So, acceptance of the list with the deletion, three different categories and three different reports.

DR. MARKS: Yes.

DR. BERGFELD: I call the question, all those in favor of that decision? Thank you, unanimous.

SEPTEMBER 2020 PANEL MEETING – Silicates - 1st Review Amended Draft Report

Belsito's Team – September 14, 2020

DR. BELSITO: Okay. Anything else to go in the discussion? Okay. If not, then we move on to silicates. And again, Christina, I'm assuming that the Wave-2 or whatever comments from PCPC will be incorporated.

MS. BURNETT: Yes, they will be.

DR. BELSITO: Okay. Okay. So these are conglomerations of reports from 2003, 05, 09, and add on ingredients. And we looked at the grouping and we didn't like it so then we split it into three different groupings. And this one is basically the silicates and the silicate salts. And then there was a whole question about whether some of these were derived from mined ingredients versus synthetic. And I presume that that has been answered. Is that correct?

MS. BURNETT: I think there's still a question on some of them, partially based on how the definition in the dictionary presents them.

Synthetic Amorphous Silica and Hydrated Silica – Expert Panel for Cosmetic Ingredient Safety Meeting Transcripts

DR. BELSITO: Okay. Then I thought we had some -- we were going to have some language that we're reviewing synthetic amorphous and not mined. Is that not correct?

DR. LIEBLER: That was my understanding that this report is only going to deal with synthetic amorphous silicates.

DR. BELSITO: That was my understanding. And then just a few questions. So, Dan, when we last looked at this, Ron Hill had an issue with the silver ingredients. Do you and is the cluster okay?

DR. LIEBLER: The cluster is fine. I don't have an issue with the silver. And with respect to synthetic amorphous versus mined, I thought that was the previous silica report we did last year. I thought this one was where we got into the ingredients that could include mined silicates.

MS. BURNETT: That was my understanding. Yes. We did the synthetic amorphous silica and hydrated silica last year.

DR. LIEBLER: Yeah.

MS. BURNETT: The rest of these ingredients were cleaved off because some of it just, it was not clear and we had data indicating that some of these silicates were, you know, synthesized from sand and the sand we didn't know where that source was.

DR. LIEBLER: Yeah. So this is a mix. So, I mean, let me just give you my take on these, Don, if it's okay. So the only ingredients with uses are already reviewed. They're red. Only sodium, magnesium, aluminum silicate has no listed uses.

And so the tox profile on these looks favorable. There's no absorption going to be for any of these. Method of manufacture and composition's reasonably accounted for in my view by the examples and by the general descriptions for alleviating members of the group. Table 1 provides appropriate supporting information for that.

The impurities are really unevenly covered but they're acceptable of examples are likely representative of the other ingredients. Other than skin, the main tox hazard is inhalation and these agents appear to not to have a component of crystalline silica. But we should get some information to confirm at least for representative members of the group. And we can probably handle the inflammation as in our past reports with reference to particle size limiting respiration. Those are my top-level comments on this report.

DR. BELSITO: Yeah. So under composition and impurities for magnesium aluminum silicate it says, crystalline silica in the form of cristabalite. This is PDF page 187. And again, I thought we were going to make a very strong comment that we were reviewing these only when manufactured using amorphous silica.

DR. LIEBLER: Well, most of these just don't correspond to that constraint. I mean if we apply that constraint many of these ingredients just go away.

DR. BELSITO: Okay.

DR. LIEBLER: But they're in use so I think we have to deal with them as they are.

DR. BELSITO: Okay. So you're -- how are you dealing with the respiratory?

DR. LIEBLER: Well, I mean, that's the thing that we have to discuss as a group.

DR. BELSITO: Okay.

Synthetic Amorphous Silica and Hydrated Silica – Expert Panel for Cosmetic Ingredient Safety Meeting Transcripts

DR. LIEBLER: I think that here we've got a bunch of ingredients that are in use that are perhaps to some extent synthetic but much of them are naturally produced and mined and purified. And we have in general favorable safety profiles. The real wild card is inhalation and we're concerned about crystalline silica in that context. So the question will be how we handle it.

Do we simply put limits on crystalline silica, do we say that no -- absence of crystalline silica is a requirement? So that's what I figured we'd need to discuss but we certainly can't limit these to synthetic amorphous silica. That's the previous report. It's not really applicable to this class of ingredients because that's not where they come from.

DR. BELSITO: Okay. Then let's go through the document and then we can get to the discussion and where we will be tomorrow.

DR. LIEBLER: Yeah.

DR. BELSITO: On page 13 under composition and impurities for aluminum silicate, it says that that sentence, it comes from an old report. It says, "...and ton...." Is that iron or tin?

MS. BURNETT: I'm sorry, which PDF page are you on?

DR. BELSITO: PDF page 187, the aluminum silicate composition, and impurities. The last word is ton, T-O-N. I'm not sure if it's iron or tin.

MS. BURNETT: Let me quickly check for you.

DR. LIEBLER: I mean, it's a list of sort of oddball mineral names.

DR. BELSITO: Right.

DR. LIEBLER: I thought drosophila (phonetic) were quirky but this is nuts.

DR. KLAASSEN: I suspect it's a name just like those other ones that we have there that we aren't familiar with. Like dickite.

DR. EISENMANN: This is Carol. I was wondering if some of the crystallinity levels mentioned in Table 3 should be mentioned in this text in this impurities section because that's what you're concerned about.

DR. LEIBLER: Yeah.

DR. EISENMANN: So I thought maybe you should actually mention it in the text.

MS. FIUME: Christina, I found it. In the original text it did say ton in the original report. It's on PDF page 218.

MS. BURNETT: Then Budavari is a Merck index citation, correct?

MS. FIUME: It is.

MS. BURNETT: I can go check later what the current Merck Index definition is.

DR. BELSITO: So Carol, you're suggesting that the levels of crystallinity which are all less than 0.2 percent be listed in composition and impurities. Is that correct?

DR. EISENMANN: Well, wouldn't have to be every single one but like a range that this table contains some information on levels, of maximum levels of crystallinity in these ingredients.

Synthetic Amorphous Silica and Hydrated Silica – Expert Panel for Cosmetic Ingredient Safety Meeting Transcripts

DR. BELSITO: But there're only six ingredients there.

DR. EISENMANN: Well, you could list which six it mentions.

DR. BELSITO: Okay.

DR. LEIBLER: I mean, that corresponds to most of them anyway.

DR. SNYDER: So, yeah. I thought the reason we cleared this group was because crystalline silica was not an issue in the synthetic amorphous silicate.

DR. LEIBLER: But Don --

DR. SNYDER: I thought that's the only ones that were used in cosmetics even though there are other ones.

DR. LIEBLER: These groups aren't synthetic. So it's true what you said about crystalline is not part of synthetic amorphous silica but that really applies to the last report. And this report is the ones that weren't necessarily synthetic. In fact, I think the majority of these are not synthetic.

DR. BELSITO: Okay. The next question I had was why EU has restrictions on zirconium. It's banned. And aluminum in colorants only. This is PDF page 188. Do we have any idea where that comes from?

MS. FIUME: I don't know. Alex or Carol, do you have any idea?

MS. KOWCZ: I'm looking it up right now, Monice.

MS. FIUME: Okay. Thank you.

DR. BELSITO: Curt, do you know anything about zirconium that would result in the EU wanting to ban it from cosmetics?

DR. KLAASSEN: Not really. I know about 30 years ago Proctor Gamble was, I think if I recall correctly, was used in -- they had to take it off if -- but I don't remember the whole story. So no, I don't know.

DR. BELSITO: Isn't zirconium used in some underarm deodorants? I know aluminum is.

DR. KLAASSEN: Aluminum is but I don't think zirconium is. It was at one time. But again, I don't necessarily want to be quoted on that.

DR. BELSITO: Uh-huh. And they're also limiting aluminum silicate to colorants.

DR. EISENMANN: So the EU for the colorant of aluminum silicate, what it actually says is, it's not limited to colorants, it's listed as a color. So what's listed as a color is natural hydrated aluminum silicate containing calcium, magnesium or iron carbonate, ferric hydroxide, quartz, sand, mica, et cetera as impurities.

DR. BELSITO: Okay.

DR. EISENMANN: And when used as a color it has to be listed as CI-77004.

DR. BELSITO: Okay.

DR. EISENMANN: So it can be used.

DR. BELSITO: So it's not restricted to being a colorant.

DR. EISENMANN: Right. It's permitted as used as a colorant.

DR. BELSITO: Okay. So then that should be deleted. And do we have any idea why zirconium is banned?

DR. EISENMANN: No. I have no idea they've banned zirconium other than those specified uses.

MS. KOWCZ: Yeah. I can't find anything, Don -- this is Alex -- also on why it's banned but the aluminum zirconium, tetrahydro- -- chlorohydrate glycine (phonetic) is an antiperspirant active allowed by the FDA in antiperspirant deodorants. So you are right. I just wanted to make sure that's clear.

DR. KLAASSEN: Repeat that, please.

MS. KOWCZ: Aluminum zirconium tetrachlorohydrate (phonetic) glycine is an active ingredient in antiperspirants, deodorants by the FDA.

DR. BELSITO: Yeah. So zirconium is allowed. It's an antiperspirant.

MS. KOWCZ: Yep.

DR. BELSITO: So I was pretty sure of that.

MS. KOWCZ: You're right, Don. I just wanted to confirm. This is Alex.

DR. BELSITO: Thank you, Alex. Okay. Okay. So we just need to get rid of the aluminum as a colorant. And then the next question I had was on toxicokinetics. This is, again, something that came from the old report on page 189. So it says, "No statistically significant absorption of aluminum was recorded in assay plasma samples of dogs given magnesium trisilicate orally."

So my question is, why would you expect aluminum absorption from magnesium trisilicate? I mean, again, it's in the old report. I think we need to check that, but it just seems curious to me. So you may just want to take a look at that, Christina. I mean if that's what it said, that's what it said, but --

MS. FIUME: Christina, can you take a look at that later and have it clarified for tomorrow, please?

DR. SNYDER: I think all this zirconium stuff, Don, may just be related to the aluminum zirconium and right at aluminum toxicity and to zirconium.

DR. BELSITO: Right. Okay. So those were just the only points I had in the report in reading through it. Did anyone else have any points in the report per se? And then we need to get into the discussion and conclusion.

DR. SNYDER: Yeah. My comments were related to the discussion.

DR. BELSITO: Okay. So I have, reviewing synthetic amorphous and not mined but we now know, and I guess Paul you thought so too, but Dan's telling us is that's not true. So then we need to consider the mined ingredients. We have some data on the very low at least on six of them amounts of crystalline silica. And the magnesium aluminum silicate that we don't have any data on the crystallinity has the greatest number of uses and the concentration of use at 21.6 percent in the eye.

In terms of respiratory incidental inhalation, it looks like we have up to 25 percent in a powder for calcium silicate, 23 percent for aluminum silicate. So we have some high powder concentrations. Sprays are around 1 percent that are known. Everything else sort of has asterisks or footnotes around it. So how do we deal with that? And magnesium aluminum silicate is 33 percent incidental inhalation in powder. So where are we with that? This is not my area of expertise. In terms of skin, I think it's just formulated to be non-irritating.

Synthetic Amorphous Silica and Hydrated Silica – Expert Panel for Cosmetic Ingredient Safety Meeting Transcripts

DR. SNYDER: And it's the same for the respirable because the issue on inhalation it's -- the respirable is not really an issue. It's irritation. So as long as it doesn't contain the crystalline silica. So I think this discussion has to be crafted with the method of manufacture, the difference between the natural and the synthetic amorphous.

We have to make sure that we're very clear about we're using current terminology because of all of the fumed silica and all that confusing terminology. So we need to clarify the terminology you use. We need to discuss the crystalline silica issue that there is, it has to be, you know, down near non-detectable levels. And then inhalation issues for me were two. Respiratory is not really an issue. Irritation is. So that's what I wanted to be captured in the discussion.

DR. LIEBLER: You hit all the main points for me as well, Paul.

DR. BELSITO: So non-irritating to skin and inhalation?

DR. SNYDER: Well, the incidental exposure should minimize, or there should be minimal, you know, use should - the user should be aware that incidental inhalation could result in irritation, respiratory inhalation from incidental exposure but not from any toxicity standpoint.

DR. EISENMANN: I'm a little concerned about trying to say that crystalline silica should be non-detectable. Now I've been looking at the recent -- it's last year's ATSDR profile on silica and they, you know, summarized ambient air levels. So urban outdoor air levels of crystalline silica in the particle size range of 0.3 to 10.5 micrometers was reported as 0.25 to 2.87 micrograms per meter cubed. So there is, I mean, there is a normal level of crystalline silica out there in the air in the respirable size, in the respirable range.

So I don't think you say non-detectable. I agree it should be low, but everybody needs to consider what the level is. And you need to have a lot of detail in the discussion, but to say non-detectable I think is not appropriate.

DR. SNYDER: But I think you hit the nail on the head. Do we have a level, and NOAEL level for crystalline silica?

DR. EISENMANN: No. You don't have NOAEL.

DR. SNYDER: Right.

DR. EISENMANN: So it will difficult that's why I was going to suggest maybe you look to this ATSCR profile to give them, whoever's reading this, what is ambient air level. I don't know what you'd like to be below it, but --

DR. LIEBLER: Well, how do those levels relate then to the maximum 0.2 percent that we have data on in that table? Is that within that -- is that 0.2 percent within that range of the ambient?

DR. EISENMANN: 0.2 -- I'm not sure. You mean that --

DR. SNYDER: That Table 3 where it said, they were all 0.2 percent or less.

DR. EISENMANN: Well haven't tried to do any calculations.

DR. SNYDER: So I think we need that. We need to have some scientific basis. And the reason I was just defaulting to no detectable levels because we don't have any level that we know is safe. We don't have a NOAEL.

DR. EISENMANN: Right. But it is out there, and we are breathing it so there must be a level that our lungs can clear a little bit of it.

DR. BELSITO: Does NIOSH or OSHA have levels? I mean, these are things that people work with.

Synthetic Amorphous Silica and Hydrated Silica – Expert Panel for Cosmetic Ingredient Safety Meeting Transcripts

DR. EISENMANN: Yes. The OSHA action level is 25 micrograms per meter cubed.

DR. BELSITO: Is that --

DR. EISENMANN: Over an eight hour workday. And the PEL, permissible exposure limit, is 50 micrograms per meter cubed.

DR. BELSITO: Is that in the current report? I don't remember seeing it.

DR. EISENMANN: This is for crystalline silica so it's probably not in the current report.

DR. BELSITO: Then don't we think it should be in there? Because that at least gives us a frame of reference.

DR. SNYDER: That's where I'm -- I totally missed something here because I had that this was -- silicosis was not an issue for this report because there's none in the synthetic amorphous silica but I think I missed --

DR. LIEBLER: Well, you're -- yeah, you're thinking that these are all synthetic amorphous and they're not.

DR. SNYDER: Okay.

DR. BELSITO: Well, the people from SASSI, I think, told us that what they manufacture in terms of these are from synthetic amorphous. But they could not state that that was true for other producers that were not members of their association. So that was my recollection from going through the number of sessions that included this. And I'm just trying to find that now.

DR. SNYDER: Well, it seems to me that our conclusion's going to have to say that the crystalline silica levels are going to have to be below a certain level to be safe as used. Otherwise, we have to say we can't say they're safe because the natural ones, we don't know what the levels are.

DR. LIEBLER: Well, the problem is setting a level then.

DR. SNYDER: I know, that's -- yeah.

DR. LIEBLER: Got an ambient background, which Carol was just talking about.

DR. SNYDER: But even background air is not -- in some respects when you're using a cosmetic it's a concentrated exposure. It's not background air, kind of. You know what I mean?

DR. LIEBLER: Right. Yeah. But, I mean, there is this background to consider.

DR. SNYDER: Right.

DR. LIEBLER: We may be better off simply saying it needs to be minimized.

DR. SNYDER: Or that they should only use synthetic amorphous because they then can control it.

DR. LIEBLER: Well, that may preclude many of these ingredients though.

DR. SNYDER: Right.

DR. LIEBLER: Which have, I mean, the thing is, many of these ingredients we've already reviewed these and they're safe. Most of them actually. Now, we may have in the past simply come to the conclusion -- we may have excluded respiratory effects based on expectations of particle size at respirability.

Synthetic Amorphous Silica and Hydrated Silica – Expert Panel for Cosmetic Ingredient Safety Meeting Transcripts

DR. EISENMANN: In the discussion, I would think it would be helpful if you said something like, dependent both on the levels and the ingredients. If you're going to use it in a product that is inhaled the crystallinities must be really low, the part -- you need to control the particles. You can say all those -- all the factors that would decrease exposure.

DR. LIEBLER: Right.

DR. SNYDER: Well it seems like there's still two issues. We have to discuss the crystalline silica in the discussion. The particle size we can deal with our normal boilerplate, so I'm not worried about that. It's this crystalline silica and what we're gonna say is an acceptable level.

DR. LIEBLER: I don't think we're ever gonna have the data to allow us to say that, Paul.

DR. SNYDER: I know. So --

DR. LIEBLER: I think that maybe a different approach is needed in our discussion. Which is to say we have a paragraph that discusses, that says -- begins, the panel, you know, discussed the issue of respiratory toxicity risk and identified that the major contributing factors to be considered are the percents -- the fractional composition of crystalline silica and the respirable particle size in the cosmetic products.

DR. SNYDER: Well, no, again, I want to reiterate this. The crystalline silica is separate. The crystalline silica is a major issue and then regarding, even the ingredients that don't have significant levels of crystalline silica, irritation still is an issue. And it's even the upper respiratory -- it doesn't have to be lung. It can be up in the nasal passages and the trachea. We've got data that suggests that they are irritants.

DR. LIEBLER: Uh-huh. Of course. Okay. I'm just trying to figure out how do we deal with the crystalline silica issue without data.

DR. SNYDER: Yeah.

DR. LIEBLER: And without a basis for setting an upper limit.

DR. SNYDER: I mean, Carol's idea of saying that they shouldn't exceed the normal ambient levels as reported by those two regulatory agencies that reported what the ambient levels are.

DR. BELSITO: Well, the OSHA restrictions.

DR. SNYDER: OSHA, yeah. And NIOSH. I thought it was OSHA and NIOSH.

DR. BELSITO: Carol, was it just OSHA, or does NIOSH have a restriction? And or EPA?

DR. EISENMANN: I gave you the OSHA values.

DR. BELSITO: Okay.

DR. EISENMANN: The ambient levels came from an ATSCR profile, which is summarizing all published data on this one silica -- on silicates. They combined all the silicates in one report.

DR. BELSITO: So that wasn't from EPA?

DR. EISENMANN: No. It was from ATS- -- Agency for Toxic, Substance, and Disease Registry, part of the CDC.

Synthetic Amorphous Silica and Hydrated Silica – Expert Panel for Cosmetic Ingredient Safety Meeting Transcripts

DR. BELSITO: Okay. Well, I think that would be added to the report would be helpful. At least it would give us some range and then where do we go with that in terms of the discussion? That should be formulized to minimize crystalline below levels that are irritating to skin and respiratory tract?

DR. SNYDER: The irritation doesn't have anything to do with the crystalline. These things are irritating if you inhale them irrespective whether they have the crystalline silica or not. The crystalline silica is the one that causes the silicosis.

DR. LIEBLER: Silicosis.

DR. SNYDER: Yeah. Yeah.

DR. BELSITO: So they should be formulated to minimize respiratory and skin irritation?

DR. SNYDER: Correct.

DR. BELSITO: Okay. So then where do we go with the crystalline silica?

DR. SNYDER: Well, I think we have to have it in the discussion that it is a concern. And then we have to have some basis for giving guidance as to what we consider to be acceptable or what basis we consider to be unacceptable. And we have the data that's 0.2 percent and I'd like to know how this compares to the ATSDR levels of the ambient levels. Because you certainly couldn't get below ambient.

DR. BELSITO: Well, we know that it's used in sprays. What is it, 1 to 2 percent, powders as high as 33 percent?

DR. SNYDER: Yeah.

DR. BELSITO: Carol, is that data -- I mean, I don't know anything about respiratory toxicity. Can you calculate usage on powders and what an average consumer would be exposed to and --

DR. EISENMANN: It would have to be left up to the company to -- you would expect the company to do it because all the products would be different. So if you could do an example but it wouldn't necessarily be representative.

DR. LIEBLER: Right.

DR. BELSITO: Okay. So we, in the discussion we identify crystalline silica as a concern and what do we say about it?

DR. SNYDER: Well, I mean my opinion is, it needs to be severely restrictive levels. Even for incidental exposure. And so, but again I don't think we have data to say where that cut off is, what's acceptable and what's not acceptable. That's what we're trying to do, we're trying to finagle this by using other available data to say that it should not exceed what's normally ambient in the air. That you are gonna be exposed to anyway.

DR. BELSITO: But then as you said, using a spray is quite different than ambient air.

DR. SNYDER: Yeah. I think unless somebody tells me otherwise that's what I believe.

DR. KLAASSEN: Maybe we should say that it should not be, maybe we should quote ban it.

DR. SNYDER: Well --

DR. KLAASSEN: Because --

DR. SNYDER: -- to Carol's point, you can't totally ban it because anything you measure is going to have at least ambient levels in it.

DR. KLAASSEN: Well, yeah. But I mean, that doesn't mean that you add it. It's not an ingredient if it's in normal air. But, you know, if they want to -- I mean, if we can't come up scientifically with a safe dose, safe concentration and it doesn't seem like we can, why approve it? You can make it without having this problem.

DR. BELSITO: Well, SASSI told us that their silicates are made with amorphous. We just don't know which ones they make. So apparently it can, I mean, if I'm reading the minutes correctly, is that not correct, Christina, that the representative from SASSI indicated that these silicates that they made were from amorphous?

DR. KLAASSEN: That was my understanding.

MS. BURNETT: I believe that was my understanding, too.

DR. BELSITO: So --

DR. LIEBLER: When you're saying ban it, you're talking about saying it should not be used or data not sufficient to support safety in products that may be inhaled.

DR. KLAASSEN: Correct.

DR. BELSITO: No. What I'm saying is that data is not sufficient to determine the safety of mined silicates for products that could be inhaled. However, silicates that are formulated using amorphous silica would be safe in those products.

DR. LIEBLER: Okay.

MS. BURNETT: To remind the panel, this is at the draft stage. You have the ability to issue an insufficient data announcement and identify what you would like and at the next meeting, you can then reach a tentative conclusion.

DR. LIEBLER: Yeah. That was --

DR. BELSITO: What I would like is, so we add the OSHA restrictions and the CDC environmental levels to this report. And maybe ask the representative from SASSI to attend our next virtual meeting in December to discuss with us whether in fact that we are correct in our assumption that at least the silicates that are made by companies belonging to this organization are made using amorphous silica and not mined silica. And then we would add, you know, that they're safe as used.

However, products that, or cosmetic products with a potential for inhalation are safe only when manufactured using amorphous silica and not mined silica. Because that's our only concern, right, is with the respiratory for the mined silica? And then say they should be formulated to minimize respiratory and skin irritation. I think I would like -- because when SASSI was approaching us they were approaching us when we were looking at all three different groups. I would like to hear what they specifically have to say about this grouping.

DR. SNYDER: Right.

DR. LIEBLER: Because we just don't have a feel for which of these are mined and which are synthetic amorphous in origin.

DR. BELSITO: Yeah.

DR. LIEBLER: And then that's what's missing in method of manufacturing for all of them.

DR. BELSITO: Yeah.

DR. LIEBLER: And maybe that should be an insufficiency right there.

DR. BELSITO: Yeah. I mean, I think our only insufficiency is determining which are made with synthetic amorphous, which are mined, whether they can be made with synthetic amorphous.

DR. EISENMANN: Unfortunately, I think they can be either-or. Each ingredient can be mined or made from synthetic.

DR. BELSITO: Yeah.

DR. EISENMANN: I think that's going to be the problem.

DR. BELSITO: Well, but then that, you know, once we get that confirmation from SASSI that each of these ingredients could be made from mined or synthetic amorphous what we can do in the conclusion is, safe as used when formulated to be non-irritating, non-sensitizing in products without the potential for inhalation. Products with the potential for inhalation they're safe as used when manufactured using amorphous silica, not mined silica.

DR. LIEBLER: Yeah.

DR. BELSITO: So that's sort of a split conclusion.

DR. LIEBLER: Yeah. Yeah.

DR. BELSITO: If you're going to use them in a product that could be inhaled it needs to be a silicate that is produced from amorphous silica. But I would just like to hear from SASSI again on that.

DR. LIEBLER: Oh, we will.

DR. SNYDER: Don, the document that Carol's referring to is that ATSDR CDC document actually has a table in it. The summary of environmental levels of silica with low and high levels of both crystalline and amorphous silica. So I think that would be an important reference for us to talk about if we're going to get to a level that we are going to say is acceptable.

DR. BELSITO: Okay. Okay. So we'll incorporate that, see it presumably in December. Well, the turn around time, we're 60 days now not 90? So maybe we can have SASSI discuss with us in the December meeting with this specific about how these silicates can be manufactured, whether amorphous silica -- whether our impression that they could be manufactured from amorphous silica is correct.

So the insufficiency is manufacturing from amorphous and or mined. And then we don't -- if they can all be manufactured theoretically from amorphous silica then I think we resolve the respiratory issue by saying that the cosmetic products that could be inhaled should be -- contain silicate ingredients that are manufactured using amorphous silica, not mined silica. Does that make sense?

DR. KLAASSEN: I agree.

DR. LIEBLER: Yeah.

DR. BELSITO: Okay. Any other --

DR. SNYDER: That's a good starting point.

DR. BELSITO: Okay. Any other comments? Okay. Hearing none. It's 12:05. We meet again at 1:00 p.m.

Marks' Team – September 14, 2021

DR. MARKS: And then the next one is the silicates, and that's the last one. Is that correct?

DR. BERGFELD: Yes.

DR. SLAGA: That's correct.

DR. MARKS: Okay. Well, David, we're moving through these -- sometimes it doesn't go this smoothly. I hope I don't jinx the silicates.

DR. PETERSON: Well, it took me like three hours to get all the history -- you know, to read through all that stuff, which I felt I needed to do in order to put it in context. So...

DR. MARKS: Good for you, Lisa. I'll see --

DR. PETERSON: It was a lot.

DR. MARKS: You can correct my context then if not. And Christina, this reminds me of citrus that you dealt with a few years ago. Yeah. Look at that nonverbal communication. So any rate, the silicate -- why -- I must have made a note and covered your memo date, Christina. But any rate, the silicate family included ingredients from reopened reports that had been published in '03, '05, '09, along with additional add-on ingredients.

In December of '19, the Panel considered the proposed grouping for three different mineral ingredients and accepted the proposal grouping of the 24 silicate ingredients in this report. And just to kind of put it as I have, in September of last year, my perspective, Lisa, we found safe synthetically manufactured amorphous silica and hydrated silica when formulated to be nonirritating. Crystalline silica is not equal to synthetic silica, and pulmonary toxicity is the main concern. So that's why we split this out.

And any of the ingredients that we reviewed at the time with amorphous silica and the hydrated silica -- if there was any suggestion that the method of manufacture included crystalline silica, we just eliminated that. So as you say in your memo, in December of last year we decided to do three groups of ingredients containing crystalline silica, and this is the review of just the silicate group, 24 ingredients. 17 of these ingredients were previously reviewed with a safe to avoid irritation conclusion, so there are two different conclusions, two different reports. And in your introduction, Christina, on page 186 in red you have those previously reviewed ingredients. And then the summaries are in different pages for 2003, 2005 report -- again, always inhalation is the main issue.

Any rate, I think with that background, Lisa, if you want to add anything more on the background, that's fine. I'm going to ask for your, Ron, and Tom's input and comments at this point.

DR. PETERSON: So I think my understanding was that -- so I got that the synthetic compounds were considered safer than the mined compounds because of the crystalline thing. But some of these synthetics are actually made from sand, and so the concern was the impurities could represent -- there could be some crystalline particles as impurities in the preparations. And so what I gathered -- of course, I couldn't believe I kept reading and reading and reading and reading, and it kept coming.

But it seems like the big issue with these in terms of this -- I think you can do a risk assessment about how much crystalline material is there, but I think it struck me that the important thing was to find out that the method of manufacturing and then the characterization of the product -- to know what the impurities are and whether there was any potential for crystalline impurities still being there, understanding that they're going to be at a low level. And the importance was from an inhalation perspective. Did I capture that right, that that was the big issue over the how do we separate these out?

Synthetic Amorphous Silica and Hydrated Silica – Expert Panel for Cosmetic Ingredient Safety Meeting Transcripts

And finally, we'll separate them out by the synthetics, but then there was a big concern -- a big discussion around these synthetics that were made from mined material or sand where there still could be the potential for contamination with the crystalline material. So for that then I think it's really important that we have method of manufacturing and some understanding of what the impurities are because there are some of the compounds for which there are methods of manufacturing that were made from sand, for example. And I think it was those materials that -- where there was a concern that, if there wasn't some kind of purification that would eliminate the crystalline material, there was a potential of being crystalline material present.

DR. MARKS: Yeah. That's exactly how I interpret, Lisa. Ron and Tom, I'll ask your input. I'll also though -- a little bit of an aside, is there anybody from SASSI that is tuned in or another silicate industry representative? If there is, I'd like to have your input also as we discuss this. We had a lot of input about amorphous silica and the hydrated silica from SASSI, and they were the ones that reassured us that those ingredients didn't have the crystalline silica in it and therefore have no pulmonary toxicity. Ron Shank and Tom?

DR. SHANK: Well, we need inhalation toxicology. There's none. If the Panel doesn't want to go that way, then you'd have to rely on the boilerplate.

DR. MARKS: It's kind of interesting because we're going to be reversing the safe conclusion for 17 of these but at that time probably didn't know, as you elucidated, Lisa, that we aren't certain how much crystalline silica were in these previously reviewed ingredients.

DR. PETERSON: Right. And I do think the science has shifted over time. We have more knowledge now, and I think that there's lots of things we thought once were safe that we now know -- you know, you get new information. You have to reevaluate.

DR. MARKS: So I guess, Tom, do you have any input because I think it's going to come down to insufficient data announcement or do we have a safe conclusion based on what was all done before? But formulated when not to be inhaled and not irritating. How's that Ron Shank? Formulate not -- and then put the boilerplate. But any rate, Tom, do you have any input on this?

DR. SLAGA: Well, I think the possibility of the impurities of the crystalline should be considered, and maybe if I next time will have information if we ask for it -- someone from the industry will either clarify this or not.

DR. ANSELL: Well, we have had the industry. I mean, Lisa's concern is legitimate and perhaps should be added to the discussion. But the fact is that for the synthetic material we have significant amount of inhalation data showing they're not the concern. So we do have a great deal more knowledge today than we did in terms of the inhalation safety of the silicate and non-silicate materials, and we believe that we've drawn a good line in the description to include those materials which do not contain the crystalline material. And if we want to expand the discussion about the concern about silicates, that's fine, but a lot of this analysis in terms of risk assessment would really be better elaborated in a crystalline silica report, not brought into the non-crystalline silicate report.

DR. MARKS: But Jay, how would you handle -- that was what came up with the SASSI before. How do you handle that in the method of manufacturing there may be clay, as Lisa said? And we don't know how much.

DR. PETERSON: And actually, for the two ingredients that are most used, there is not a methods of manufacturing for those. So to me, that would help a lot -- to get the method of manufacturing for those that are most used. But it's interesting. It's kind of like the thing with the saccharides. For the things that are used most you have the least -- you don't have the key information that you need to handle a discussion about this topic.

DR. BERGFELD: So Jim, do you want to state your position then?

DR. MARKS: I was going to -- yes, I was typing it as I was going along. So I think, again, team, tomorrow we'll be seconding. At least our position's going to be an insufficient data announcement, and we want the method of manufacturer for the silicates that are most used. And we want the composition as to how much crystalline silica is

Synthetic Amorphous Silica and Hydrated Silica – Expert Panel for Cosmetic Ingredient Safety Meeting Transcripts

in it. And we acknowledge the whole issue is inhalation toxicity, which will need to be dealt with in the discussion and then perhaps in the conclusion because I had as an alternative, if we did a tentative amended report as I said, can you say safe when formulated not to be inhaled and not irritating?

We have to carry through the irritating, I think, from before since some of these ingredients were irritating. We don't have much sensitization data, but I wouldn't expect it to be. We just have data on three ingredients: the aluminum, potassium, and the zinc silicate. And multiple ingredients not surprising were irritants. If you rub clay or a similar solid material, I wouldn't be surprised that it's irritating both to the skin and the eye. So team, how do you want to go? Do you want to go with an insufficient data announcement tomorrow?

DR. SHANK: Yes.

DR. PETERSON: Yes.

DR. SLAGA: Yeah.

DR. MARKS: And did I characterize that, Lisa, correct with method of manufacture for silicates most used and composition?

DR. PETERSON: Yeah. Composition impurities. The way you phrased it when you said it before was right.

MS. BURNETT: But there is no specific ask for inhalation toxicity data at this time?

DR. MARKS: I don't hear that. You would think if it existed you would have captured that already, Christina.

DR. BERGFELD: But if we're going for insufficient, why not ask for it? That's your concern.

DR. ANSELL: Yeah. So the method of manufacture and the composition from impurities which is present in this report is not sufficient?

DR. PETERSON: They don't exist for the two ingredients that are most used, so I think there's enough differences in those methods that have been given that you need to know. You can't read across to the other because there's big enough differences between the methods that are there. None of the methods that are there are for the two most abundant. In fact, in the two most abundant basically are 95 percent of all the ingredients that are used from this category.

DR. MARKS: Lisa, I have the magnesium aluminum silicate and the aluminum calcium sodium silicate are the two most used, and the sodium metasilicate is in the third position: 938 uses for the magnesium, 287 for the aluminum, and 133 for the sodium.

DR. PETERSON: Yeah. And the sodium we have all that information for.

DR. MARKS: Yeah. Yes.

DR. ANSELL: Okay.

DR. MARKS: Okay. So the needs for our team will be method of manufacture, composition impurities, and then we'll also ask for -- Wilma, I like your suggestion -- ask for inhalation toxicity also. Why not? That's the big concern. Be right up front.

DR. ANSELL: All right. So additional inhalation toxicity since there's extensive inhalation toxicity already?

DR. SHANK: Where?

Synthetic Amorphous Silica and Hydrated Silica – Expert Panel for Cosmetic Ingredient Safety Meeting Transcripts

DR. ANSELL: I mean, we resolved that at the last meeting that the issue is crystalline material. We want to address the amount of crystalline present more thoroughly perhaps, more granularly. But I don't think there's a question about the safety of the inhalation of the non-crystalline materials.

DR. PETERSON: But there's no data in this report about that. Now that you're saying it, there should be at least one study that says it's not hazardous because you're basing -- when you say that statement, you have to be basing it on some kind of data. And if that's true, then there's data that should be in this report that's not in this report.

MS. BURNETT: Yeah. All the inhalation data that was in the last review that the Panel finalized, the amorphous --

DR. PETERSON: In the previous one.

MS. BURNETT: It's in the amorphous -- synthetic amorphous silica and hydrated silica. We did not bring any of that data over.

DR. PETERSON: Okay. I got it.

MS. BURNETT: And if the Panel thinks that that is pertinent and relevant, I can bring a summary of that in. But based on previous discussions with whether this is crystalline or not, we felt as staff that that should not be included at this time.

DR. PETERSON: Okay. So I apologize. I keep forgetting that this document doesn't represent everything, but I do think a summary, then, would be -- since the inhalation safety is something that has been -- there's pages and pages of discussion that you guys have discussed over the years, and the inhalation toxicity is a big thing. So I think it makes sense, then. I'm sorry. I keep forgetting that you don't carry everything over. So some summary of the knowledge base there, then I think that --

MS. BURNETT: Okay. I can do that.

DR. MARKS: I might add, Lisa, that that inhalation -- and then, Christina, correct me if I'm wrong -- but all that inhalation toxicity data was relevant to the amorphous synthetic --

MS. BURNETT: Correct.

DR. MARKS: -- and not relevant to crystalline silica.

MS. BURNETT: Correct.

DR. PETERSON: Right. But you want to underscore for safety of the amorphous, so I think a little summary is really valuable because there's going to be somebody that's like me, naïve enough to think that it's not there. It's not been done.

DR. MARKS: No, I agree with you, Lisa. I just want to be sure it's clear that we can't read across from that safety data to the present silicates that we're reviewing.

MS. BURNETT: Right. I can definitely bring in a summary.

DR. MARKS: Yeah. And then I think it's very -- it's going to be very important in the discussion to differentiate -- make it clear the difference between amorphous and crystalline. Let me see. So anything else about this -- additional inhalation toxicity, Jay? So anything that's out there, that's the additional information we want on inhalation toxicity. We'll see what's out there.

DR. ANSELL: So based on -- just so I understand, based on the extensive inhalation toxicity demonstrating that these materials do not present a hazard, we believe that we need to go back and make another insufficiency in terms

Synthetic Amorphous Silica and Hydrated Silica – Expert Panel for Cosmetic Ingredient Safety Meeting Transcripts

of determining the concentration -- the potential for crystalline silica to be in some of these materials, even though these materials have not shown to be an inhalation hazard and, by the way, are not significant inhalation -- significant materials used in inhalation products? I just think Lisa's question is entirely relevant, but I had hoped that we had addressed it sufficiently before.

DR. PETERSON: But it's curious that -- I mean, I agree -- you're basically saying it's safe, so therefore we don't need to know method of manufacturing or what the impurities are. But I mean, if these are very abundantly, frequently used things, it should be easy to get the method of manufacturing and the impurities just to cross the T and dot the I and sort of remove any residual wondering.

DR. ANSELL: Yeah. No, that's fine. But typically, we would not replace an actual study with a modelled conclusion. I mean, if we have an actual study, we would rely on that more than estimating what might have happened if we had known more detail concerning the actual composition. But okay.

DR. MARKS: I guess, Jay, my comment would be is, when SASSI presented the data -- and then I remember vividly asking about these other silicates. And they said, "Well, that can be manufactured with crystalline silica." I don't know that the inhalation data, as I said earlier, from the amorphous report can be used to say it's safe for these silicates. Because unless these ingredients specifically had been studied for inhalation tox, we don't know for sure. And Christina, I think you said that all those inhalation studies that were in that particular report were relevant to the amorphous crystalline, not the other silicates.

MS. BURNETT: Correct. To the amorphous synthetic, yes.

DR. MARKS: Yeah. Okay. We're going to get another shot at this no matter what happens. We'll see what the Belsito team thinks tomorrow, and we'll react to that. I'm going to propose an insufficient data announcement for those rather than a draft amended, or it could be, again, a draft amended but not move forward with a tentative report. Does that sound good, team?

DR. SLAGA: Sounds good.

DR. PETERSON: Yeah.

DR. MARKS: We're certainly not willing at this point to go forward with a safety conclusion until we get more data. Okay. And in the September 9th memo from Alex that pyrophyllite is approved cosmetic color not to be used in the eye area and mucus membrane. So we need to incorporate that caveat from the memo in the report. And depending, we may need to include that in the conclusion. I don't know. I'll let you guys figure that out. But everybody, I just want to note that memo from Alex. Jay, did you have any comments about that?

DR. ANSELL: No, it was just an item for the use. It has a use as an approved colorant in the U.S. and Europe for general cosmetics.

DR. MARKS: Yes. Right. But it sounds like at least there's been some restriction put on it as far as eye area and mucus membrane.

DR. ANSELL: No, it's just the opposite. Unless it was specifically petitioned for eye use, it would not be included. So it's not like it's evaluated for every use. It's evaluated for general use, but unless it's specifically evaluated for lip products and eye products -- or to be a lip product or an eye product you have to specifically petition for that application. The lack of its presence doesn't mean that they put a prohibition based on the data submitted.

DR. MARKS: Okay. Interesting. Good. Thanks for clarifying that. We'll get that -- it sounds like that at least needs to be in the discussion. Any other comments about the silicates? If you aren't confused yet, David, you will become more confused as we go further into the next rendition of this. Are there any other ingredients we have to -- or any other items to discuss?

DR. BERGFELD: I think you're done.

Full Panel Meeting – September 15, 2020

DR. BELSITO: Yeah, so this includes ingredients that were reopened from multiple reports in 2003, 2005, 2009. We tried to combine them all and that didn't work. And, then we decided to split them up into three different groups. And, this is the second of the three groups that we're looking at.

And, basically, the question was that our team seems to recall that the representatives from SASSI indicated that the silicates that they produced were manufactured from amorphous silica and not mined. And, so it wasn't clear to us whether all of these various silicates in this report could be or are manufactured from amorphous. If they are, then they're safe as used, but if any of them are mined, then they're safe but not in products that could potentially be inhaled.

So, we thought at this point, I guess, that it was insufficient, or could be tabled, we said insufficient. We would like at the next meeting the representative from SASSI to come back and specifically discuss this group of silicates in terms of whether they are manufactured using amorphous silica or mined.

DR. BERGFELD: Or both, maybe.

DR. BELSITO: Or both, in which case we would have a split conclusion. We also felt that there is information from OSHA in terms of restrictions, and on CDC environmental levels, that can be brought into this report. So, we would like those added in in the next iteration. But I think the most critical thing is to get the representatives from the manufacturing association back to discuss these particular silicates with us.

DR. LIEBLER: This is all about whether or not we've got crystalline silica in these as the inhalation risk.

DR. BELSITO: Right.

DR. MARKS: Yeah, our team had a similar discussion. We will second that. What we asked for was method of manufacture for the silicate most commonly used, what the composition of impurities, specifically how much crystalline silicate was present. And then we also just put in there if it exists we'd like additional inhalation toxicity studies. So, I think we're on the same page. I guess I'd ask Bart does this go out as a -- I guess it can't go out as an IDA.

DR. HELDRETH: It can.

DR. MARKS: Is this a draft amended and just asking for more information in a draft amended report?

DR. HELDRETH: I suggested that it go out as an IDA.

DR. MARKS: Okay.

DR. HELDRETH: And, I can write a formal letter to the folks at SASSI, before the week is out, so that they have plenty of time to prepare.

DR. BERGFELD: Thank you. So we've had a motion and a second of that motion to go an IDA. Any other comments?

MS. BURNETT: Can you please restate the needs for the IDA?

DR. BERGFELD: Sure.

DR. BELSITO: We wanted to know manufacturing and impurities essentially of the crystalline, similar to Jim. We wanted the OSHA restrictions and the CDC environmental levels added. It seems like Jim wanted to see if there's any additional inhalation data out there that can be brought in. Is that correct, Jim?

DR. MARKS: That's correct, Don.

DR. LIEBLER: I mean, with respect to method of manufacturing, you know, detail process is perhaps less important than knowing whether or not it's mined or synthetically produced, and then the composition of the impurities with respect to crystalline silica. Those are the key pieces of information we need I think to get any further.

DR. PETERSON: I second that need, yeah.

DR. BELSITO: Yeah, in reviewing all of the minutes from prior meetings, I believe I was correct when I stated yesterday that the representative said that the silicates that their member companies produce are from amorphous, but that there could be silicates that are produced by non-member companies that are mined.

What I would like to get a sense of is, looking at all of these various ingredients, could they in fact be made from amorphous silica without using mined silica.

DR. MARKS: Don, my recollection is just the same as yours, and that brought up a red flag for all these silicates.

DR. BELSITO: Right, thank you Jim.

DR. SNYDER: That would suggest we could go the safe as used and say unsafe if the source from mined, for any products that has a potential for incidental inhalation, right?

DR. BELSITO: Well, that the other –

DR. SNYDER: I think we're going to be there no matter what data we get, because (inaudible) has a minimum of two to three percent up to 76 percent crystalline silica. We have enough toxicity data; we understand the toxicity of crystalline silica. The respiratory issue as I saw going forward is only as an irritant to the upper airway. You know, in lieu of the fact that we were assuming there would be no crystalline silica in any aerosolized formulation.

And, so I'm not certain, I think we're just postponing this whole thing. I think we have all the data we need and we should just state that because of the crystalline silica issue that we can -- I don't think we'll ever be able to say safe from mined.

DR. BELSITO: Right, I mean, that was the other point I made, Paul, that we did discuss coming in with a split conclusion that they were safe for use in products without the potential for inhalation. And, would be unsafe for products with a potential for inhalation if they contained, or if they were manufactured using any component of, mined silica.

DR. SNYDER: Because the discussion also we had with Carol from that ATSDR-CDC study one said that ambient air has a natural level. So we said well we'd just have to say can contain none. Well, we can't do that and yet we don't know a limit. We don't have the data to have a limit nor will we ever probably have the data to suggest what a limit is. So I think we're going to be right back to the same place. Even if we get more data then we're going to say that we don't think it's safe to use any mined silica because of the risk for crystalline silica.

DR. LIEBLER: But, Paul, for products that can be inhaled, right?

DR. BELSITO: Right?

DR. SNYDER: That's correct; only for products that are aerosolized.

DR. LIEBLER: So, we're in agreement here.

DR. BERGFELD: Jim?

DR. MARKS: Well, that would be we'd need another motion if we're going to move forward with a tentative report that has that conclusion. And I hear you loud and clear, Paul. I thought that's a very creative way of dealing with the issue of the crystalline silica.

But I still think we should have the method of manufacture for the silicates most used. And, your suggestion as a conclusion, Paul, we should keep that for the next rendition, which would be a tentative report. And just see -- I don't think there's any harm in saying let's issue another IDA and see what we get? And we know the fallback position is going to be yours, Paul.

DR. SNYDER: I'm fine with that. I'm just kind of making you aware I don't think any new data is going to change what we're going to conclude. Because we're not going to get any data that are going to say that the mined is safe to use for aerosolized products or powders. And, so I think that -- yeah, I mean, even -- because you said the most commonly used, well, what if there's a not very commonly used one but it has an aerosolized use that exceeds? You know what I mean, or something.

So, again, I'm just not certain we're going to get any data that's going to help us change what we're eventually going to have to say away.

DR. BERGFELD: Don, do you want to comment?

DR. BELSITO: Yes, so, I mean, I brought that out to begin with. The other alternative would be to come with a split conclusion that they were safe as used in products without the potential for inhalation. And, that they were unsafe for products with the potential for inhalation if they contained mined/crystalline silica.

DR. BERGFELD: Now, but your initial motion was as an insufficient data announcement.

DR. BELSITO: Yeah, but I also pointed out that we had discussed an alternative.

DR. BERGFELD: Okay.

DR. BELSITO: So the original motion was insufficient; we wanted representatives from SASSI to discuss with us manufacturing, and whether they needed mined silica or how this went about. However, Paul has a good point that, you know, we will always have this issue of the potential that non-member companies could be using mined silica.

So we would probably want to cover our legal butts by saying that, you know, use of these silicates in a product that could be inhaled was unsafe if mined/crystalline silica were used in their manufacturing to any degree. So we could just come out with a split conclusion now and end it.

DR. BERGFELD: Well, it's going to be up to all of you to decide that. There is a motion, which has been seconded, which is an insufficient data announcement to request this information. And then a discussion that says maybe there's an alternative motion that needs to be made. So, we have a motion on the floor which has been seconded, so we should vote on that. And I think we can just go down individually and either vote yai or nay.

DR. MARKS: I would add, Paul and Don, I hear you loud and clear; we'll get perhaps Lisa and Ron and Tom's input. But delaying this a little bit, getting potentially more information, even though, Paul, I think you've creatively arrived at what the conclusion will be, it never hurts to get more safety data. So I would vote in favor of the motion.

DR. BERGFELD: All right. I'm going to ask Tom, yes or no?

Synthetic Amorphous Silica and Hydrated Silica – Expert Panel for Cosmetic Ingredient Safety Meeting Transcripts

DR. SLAGA: I agree with that motion.

DR. BERGFELD: How about, Ron?

DR. SHANK: Can you restate the motion.

DR. BERGFELD: Restate the motion.

DR. BELSITO: So the motion was to have representatives from SASSI re-discuss the manufacturing process for these silicates, to get more information about the use of mined/crystalline silica and manufacturing in terms of impurities, to go out and see if there are any other inhalation data that we haven't captured, and to add to the report the OSHA restrictions and the reports from CDC on environmental levels.

DR. SLAGA: I agree with that motion.

DR. BERGFELD: Wait a minute.

DR. SHANK: That's not a motion, is it?

DR. BELSITO: Yeah, it was insufficient for manufacturing, impurities particularly crystalline/mined silica, looking for additional respiratory data if available, and adding in the information from OSHA and CDC regarding OSHA restrictions and CDC environmental levels.

DR. BERGFELD: Ron?

DR. SHANK: Okay, I support that.

DR. BERGFELD: You support that. How about Lisa?

DR. PETERSON: I support that too.

DR. BERGFELD: Don, you support it?

DR. BELSITO: I just made it Wilma.

DR. BERGFELD: I know, I'm just asking you; I'm going down the list.

DR. BELSITO: Yes. Okay.

DR. BERGFELD: Curt?

DR. KLAASSEN: Yes.

DR. BERGFELD: Dan?

DR. LIEBLER: Yes.

DR. BERGFELD: Paul?

DR. SNYDER: Yes.

DR. BERGFELD: Okay, it passes unanimously. So it's going to go out as an IDA. I don't think we have to repeat the motion again, and we'll see it again. Okay. That was good.

Silica and Silicates

June 29-30, 2009

Presentation:

DR. ANDERSEN: The next item on the agenda is to hear from the folks from SASSI which is the Synthetic Amorphous Silica and Silicate Industry Association. Dave Pavlich is the association manager and has a PowerPoint presentation for us. There are limited numbers of copies, but certainly enough for the panel to look at. The rest of you can take notes on what Dave is saying. We're going to try and get this up onto the screen. Dave, take a deep breath and let's see what we can do.

MR. PAVLICH: As for the acronym, when I reserved the domain name I thought for sure I'd get some interesting calls from people to buy it, but that didn't happen. I'm also sure that there are people who go to that website and they're disappointed by what they found, and amorphous silica is probably not what they had intended to see.

The Synthetic Amorphous Silica and Silicate Industry Association is an association that has been around for a number of years but was actually incorporated and formed in July 2007. The eight founding companies that are listed here, J.M. Huber, Evonik, Wacker Chemical, Cabot Corporation, Rhodia, PPG Industries, PQ Corp. and W.R. Grace, you may or may not recognize them as being the major global producers of synthetic amorphous silica, but they are. We are also associated with a group that's a subgroup called the Amorphous Silica and Silicate Producers, so we've done some work with them in doing research, that's a group that we're associated with and we meet with them every year. I'm also here with two other representatives from SASSI companies, Dr. Jim Hathaway from Rhodia, and Dr. Gregg Daum from W.R. Grace. Dr. Hathaway is going to come up here in a little bit and go through some of the details of our comments, but at this point I'll give an introduction of why we're here.

The basic reason is that the circumstance of CIR's review of silica fits our mission particularly well, and our association's mission is to further the understanding of synthetic amorphous silica and silicate health and safety within the industry, to monitor the regulation of synthetic amorphous silica and silicates by government, to educate the public and government on the views of the industry, and to consult and cooperate with state officials and state agencies on matters having industry-wide significance, and I would add other groups like CIR. That's our purpose here.

We'd like to thank Dr. Andersen for working with us. He did attend our spring meeting in March and gave us an overview of the CIR process for reviewing silica, and then gave us the opportunity to review the March 25 scientific literature review. We did send comments in on May 12 on that review and a number of those were incorporated into the latest version of the scientific literature review, but there were a number of things that we felt were not addressed, and those are the comments that we're going to make today. I'll highlight here seven issues that we'd like to address, and then I'll introduce Dr. Hathaway to go through those in detail.

First of all, obviously a reason for our existence is to differentiate synthetic amorphous silica from other forms of silica. In the SLR we definitely feel that there is a need to have fair and accurate differentiation of SAS from other forms of silica. Also the SLR we feel needed to focus more on just synthetic amorphous silica since that's the form used in cosmetics and limit the discussion in reference to other forms of silica. This is a document that's published and is going to be available, and obviously SASSI members are concerned about misinterpretation of information.

Similarly, there are a number of manufacturing processes that are mentioned in the summary that are not contemporary and do not reflect the processes that are used for commercial manufacturing of synthetic amorphous silica, and we feel that there is too much emphasis on those noncommercial processes and the composition of the materials from those processes. Along the same lines, those references also give some information about the impurity levels which we feel incorrectly represent synthetic amorphous silica. In the toxicological studies that are referenced, there are a number of factors that Dr. Hathaway will emphasize that are important in interpreting the judging the applicability of the studies on synthetic amorphous silica. The bibliography of the SLR is very lengthy. We feel that it's relatively comprehensive but that because of the number of studies that are referenced that there is little effort to identify the more current information that's available and to emphasize the importance of that data. Finally, we were relatively surprised that in the summary, the information quoted was there were 3,276 products that contain synthetic amorphous silica and the only specific reference was to hair spray with little identification of other

cosmetic products of routes of exposure that are suspected for those products. I'll now introduce Dr. Hathaway to go through those comments in detail. Thank you.

DR. HATHAWAY: I appreciate the opportunity to provide additional comments to the CIR expert panel. I think the thing that we're most concerned about is having a very clear and accurate differentiation from synthetic amorphous silica and other forms of silica particularly crystalline silica or products that contain crystalline silica.

Unfortunately, there's a tremendous amount of confusion between these that is occurring all the time. Just a couple of years ago the insurance carriers for all of the member companies wanted to have an exclusion against any product liability for silica. Part of the problem is there's one cast number for all forms of silica and a lot of people don't understand the difference. Companies had to have extensive discussions with their insurance carriers. Once they understood the difference they limited it to crystalline silica, but to the extent that the document which will be available publicly has some confusion in it, we'd very much appreciate it if those things could be corrected so that we don't get something else out there that misinforms or confuses the public.

Instead of using the term silica, we would prefer that every time that you're referring to synthetic amorphous silica, that either that full term be used or that it be abbreviated SAS and be very clear that the abbreviation stands for synthetic amorphous silica.

Also the document contains a lot of references to the other forms of silica which I don't think adds anything of benefit to the review, and we would prefer that you have something that I'll show you in a couple more slides, a very limited discussion of the other forms of silica, and then following that strictly limiting the rest of it to synthetic amorphous silica.

Hopefully you can read it a little bit better in the document that you have. There are some things here that are not quite as clear as I had hoped they would be. If you look right here, that's the form of amorphous silica, it's called fused silica. It's essentially made by melting crystalline silica to a molten form. You form a kind of glass. In the document this was listed as if it were the major form of production of synthetic amorphous silica. I guess it's a synthetic amorphous silica, but it's not what goes into cosmetics. It would be a hunk of glass and it's not ground up and put into synthetic amorphous silica at all.

Over here in this group here, that's natural diatomaceous earth from diatoms. In nature it contains about 2 to 3 percent crystalline silica and the rest is amorphous silica. The ones that are further down that list are calcined, and when you calcine diatomaceous earth, a lot of this is used as a filter aid for filtering various products in their manufacturing processes, you form up to 70 percent crystalline silica. There are a lot of problems with the epidemiology studies that are talking about amorphous silica because in some cases they found cases of silicosis, but these are ones where there was exposure to the calcine diatomaceous earth which is up to 70 crystalline silica, and so it's very important to make a very clear distinction between what we're calling synthetic amorphous silica and these other forms that can actually contain crystalline silica themselves.

Right here, this particular area is what we think should be the focus of the document. These are the synthetic amorphous silicas that would be used in cosmetics. There are two essential processes here. One is the way process that produces precipitated silica and also silica gel, and the other one is a thermal process that produces pyrogenic silica. Unfortunately, the historic name for pyrogenic silica was fumed silica and this has the potential for tremendous confusion. Let me just show you. Over there there's a thing called silica fume. It sounds a lot like fumed silica. Unfortunately, silica fume contains crystalline silica. I think the person who drafted the document had some confusion between these two and we would of course like that cleared up as well and we would strongly prefer that the thermal process, synthetic amorphous silica, always be called pyrogenic to help avoid this confusion in terms of terminology.

As I mentioned before on that fused silica where they essentially melt crystalline silica, this is really not a commercial process that's used in anything that goes into there. It would probably be best that it be taken out of the document. You can show the kind of table that we presented in the previous slide and then after that limit the discussion to the true synthetic amorphous silicas that are used in cosmetics.

I think I've pretty much discussed both of these things already, the confusion with heating the crystalline silica to form a type of glass, and the confusion between silica fume and pyrogenic silica.

In some of the discussion of pyrogenic silica which in the document is referred to as fumed silica, they have a reference saying that it may contain up to 6 to 8 percent crystalline silica. We're pretty sure that was confusion with silica fume. Then it follows immediately after that reference with a reference from Cabot saying that their stuff is 99.8 percent pure as if there's maybe some discrepancy in which one do you want to believe. The pyrogenic silica from Cabot Corporation is indeed 99.8 percent, and any of the producers of the pyrogenic form have a very high level of purity. The precipitated silica is less pure mostly because it contains a certain amount of water and the pyrogenic is very dry. It appears to call into question the claims about Cabot Corporation about the purity and we think the way these things are juxtaposed they are potentially very misleading to reader.

In terms of the toxicology studies, I think the ones that discuss oral toxicity and dermal toxicity are pretty much fine. This is a compound that is considered safe to use in food products. In terms of skin exposure there is very little in the way of issues. Synthetic amorphous silica can absorb water, so if you put the powder directly on your skin it may cause some drying of the skin and some irritation. I don't imagine that this would be an issue the way it's used as ingredients within cosmetics, however. It could be an issue in the workplace. But there is a very key thing when we're considering inhalation or intratracheal injection studies. One of the things that creates an anomaly here is that these products as they're produced are about 100 microns in diameter and for some applications they are milled down into the maybe the 10 or 20 micron range, and that's actually a relatively smaller percentage of the total. Most of the material is actually in 100 micron range or at least about 30 or 40 microns in diameter as it would be used in most cosmetic ingredients. But if you're going to do an inhalation study and you have material that's big, anything above 10 microns is not going to get down into the lungs. So the various groups like OECD that do the toxicology protocols require that these things be broken up into something that averages 4 microns in diameter, and indeed all of the toxicology studies have had to do this in order to comply with these protocols. So you get an artificial situation where this material can now be inhaled or it can be injected down into the trachea. What happens when this is done is you have the smaller particles that have a higher surface area and although synthetic amorphous silica if you look up some of the references on solubility, they will say it's insoluble; everything is relative. Crystalline silica for example is pretty much insoluble. Synthetic amorphous silica is relatively insoluble. As you get to a larger surface area for the mass of material, you do get some of this material dissolved and it dissolves to form silicic acid. If you do break up these particles either by dispersion or by milling or by whatever means and you have an inhalation toxicology study, you're going to get some silicic formed on the alveoli of the experimental animals and you're going to get some corrosive effects from the acidic silicic acid. This is not something that you would see from even inhalation of cosmetic products or from the manufacture of these things in the protocols that workers might be exposed to during the manufacturing process because they're just not respirable in the form that they're being used. In a sense it's almost an artificial situation, and they do cause inhalation toxicity if they are broken up to those smaller sizes. One of the interesting things is though that because they are somewhat soluble under these circumstances, there are a number of clearance studies that show that this material is completely cleared from the lungs and that the reason that the studies don't find fibrosis that you would find with crystalline silica. It's something that we would recommend that before they go into the animal inhalation studies that they talk about this particle size and the fact that it's an artificial situation with all of the inhalation and intratracheal toxicology studies that were done and that you would not see this with the larger particles that are used commercially.

As Dave mentioned, the review covers an enormous number of studies. Unfortunately, there's not a lot of I guess what you'd call interpretation of weighing of which of the studies are most significant. We would like to see a little bit more of this done and perhaps more emphasis be given to some of the newer or more credible studies rather than just simply listing them all and leaving it up to the reader to try to judge which ones are most important. Most of the older inhalation toxicity studies did not discuss this particle size difference in terms of the materials being dispersed or milled down to a small particle size, that's unfortunate, and so the abstracts don't discuss that at all, but the reader is going to wonder which ones of these are really the correct situation. If you want, we would be willing to go and try to give some assistance here in terms of pointing out what we think are the more reliable and credible studies.

As Dave mentioned, we were surprised that there wasn't more discussion of the actual applications in cosmetics. That really is not a big issue with us, but it's something that you might want to consider in terms of improving the document. Here we have the spelling of our names and our website and so forth.

I'd be happy to address any questions that any of the panel members have.

DR. SLAGA: Just to have it straight, the 100 percent that is supplied to the cosmetic industry is between 10 and 100 microns?

DR. HATHAWAY: Correct.

DR. SLAGA: And only in some of the studies did an inhalation was it at 4 micron?

DR. HATHAWAY: Correct. They either break it up and disperse it some form or mill it down to that smaller diameter so it can get in there. In fact, in order to comply with the testing protocols they have to do this even though it's not representative of the material that would be involved in worker exposure or consumer exposure.

DR. LIEBLER: I appreciate the silica family tree that you provided us. I think it's helpful in organizing our thinking about this. I have two questions that relate to this. One is are there any sort of milestone dates in terms of synthetic amorphous silica manufacturing processes that would be useful in helping us interpret some of the older literature? In other words, in the 1970s or 1980s or sometime were there any changes in manufacturing processes that yielded the materials that are used in cosmetics now?

DR. HATHAWAY: I'm going to go out on a limb and make some guesses. I'm thinking that these processes probably were introduced in the 1950s or earlier. There is certainly much more production now than there was in that timeframe. But many of these articles that are from the 1950s to the 1970s still are talking about older processes and maybe there was some use of this glass that was formed from melting crystalline silica and I'm not sure what it would be today. I think a relatively small amount of these materials go into the cosmetic field. I know of the stuff that our company produces probably 80 percent goes into tires to reduce rolling friction and most of the other 20 percent goes into toothpaste, so relatively small amounts go into the cosmetic industry, but it's probably widely used in a lot of products.

DR. LIEBLER: It doesn't sound like there's a clear dividing line of any sort in the manufacturing process that would be helpful to us.

DR. HATHAWAY: Unfortunately not, but I would say the studies that would have dates after 1990 certainly would be probably more credible than ones that had dates before that.

DR. LIEBLER: I have one other question. What is the analytical method that's used to determine the content of crystalline silica in a background of synthetic amorphous silica?

DR. HATHAWAY: Usually this would be a microscopic thing. I was recently at our plant that manufactures this and even though we expected to find no crystalline silica, we went ahead and had some industrial hygiene sampling done at the site to reassure our own employees, and they do a microscopic analysis for the three forms of crystalline silica and they found nondetectable levels at extremely low levels, whereas when they measured total particulates which would include the larger particles, indeed there was a certain amount of dust exposure during the manufacturing process.

DR. LIEBLER: So the analytical methodology then probably would have been the same for a long time if you say it's microscopic evaluation?

DR. HATHAWAY: I believe so, yes.

DR. LIEBLER: So you're counting particles in microscopic fields. Right?

DR. HATHAWAY: I believe so, yes.

DR. BELSITO: As you may or may not be aware, and I guess that's my question, we're already issued two prior reports on silicates and this is the third to capture all of the ingredients that we failed to capture before. Did you have the opportunity to review those two prior published reports?

DR. HATHAWAY: This would have been before the one that came out in March?

DR. BELSITO: Yes. This is before this SLR.

DR. HATHAWAY: I don't think we were aware of that. Dave, were you aware of anything?

MR. PAVLICH: No, we haven't seen that.

DR. MARKS: In the manufacturing of the cosmetics, are there any physical changes that would occur as with a natural amorphous silica where there would be more crystalline silica produced in the end product or the use?

DR. HATHAWAY: I'm not familiar with how they're done in cosmetics. I would assume these are simply blendings, and unless you have a process that introduces very high heat, I don't believe you'd form any crystalline silica.

DR. HILL: I want to get clarification in that regard. So if they were truly amorphous rather than crystalline and they were inhaled because it was in some powdered product or some spray, what we would expect is dissolution to silicic acid and the lung is able to clear that and you'd probably talking about small amounts where there wouldn't be a toxicity issue. Is that what I heard you to say?

DR. HATHAWAY: I have a hard time imagining very much is going to be inhaled from any cosmetic use.

DR. HILL: Clearly not toothpaste.

DR. HATHAWAY: But even hair spray I have a hard time imagining.

DR. HILL: Because of the particles produced by the spray.

DR. HATHAWAY: There was one reference in the review that talked about hair spray and I believe that they said that the particles were in the 30 to 50 micron range for that particular product which is way above the respirable size and I would imagine that the proportion that might be below 10 would be very, very small. Most of the things that we've looked at have been at least 99 percent above 10 in terms of total mass of the dust. So these the amount of fines that might be below 10 is going to be below 1 percent and I would suspect considerably below 1 percent.

DR. HILL: And what is produced under those circumstances you're telling us that the lungs should be able to clear?

DR. HATHAWAY: Even when they used very large amounts of the dispersed material, this clears in the lungs. I think the half-life is less than 30 days even with a significant amount. Between SASSI and ASAP, the European equivalent of ours, we've done these dissolution studies to demonstrate this. There is also a study of three German manufacturing for synthetic amorphous silica in terms of epidemiology studies where they're looking both at pulmonary function and chest X-rays and I believe this is in the process of being written up for publication and they've found no evidence of any fibrosis.

DR. MARKS: There was one reference in which Epstein in the early 1960s injected colloidal silica subcutaneously and developed granuloma formation. Is this an example where we don't really know what was in that colloidal silica that was not synthetic amorphous silica?

DR. HATHAWAY: I'm really not sure. Colloidal sounds like it would probably be amorphous, but I have a hard time knowing. I'm not familiar with that particular article.

DR. MARKS: Can you comment about granuloma formation?

DR. HATHAWAY: There are an awful lot of things that can cause granulomas. If you implant a diamond in a rat you're going to get granulomas forming. I'm not sure it's directly related to any kind of an inhalation type of toxicity or exposure to the exterior of the skin. There are lots of things just because of their geometric shape and so forth

will cause granulomas in experimental animals especially rats. When I was in the Army and we were looking at issues with the safety of Kevlar for bulletproof vests, they implanted some Kevlar in the rats and you form granulomas around them.

DR. MARKS: I was thinking more in terms of application to damaged skin.

DR. SNYDER: Related to slide 7, the reliability of the studies, do you have additional data that you could provide us that are not in the reports?

DR. HATHAWAY: We provided two documents that are relatively recent and I think pretty thorough reviews of the issue. One of these is called the Jack Report that was produced in Europe. It's a very, very large document. Then we recently produced another document that I think is around 50 pages long that's maybe a condensed summary of a lot of that information and we did this as a voluntary effort with the Environmental Protection Agency because they're concerned about nanoparticle issues. In the manufacturing process, you start off with nanosized amorphous silica and it forms aggregates and then agglomerates to get up to the 100 micron size so the primary particles are nanosized and this was the reason that we provided that summary. It's a shorter summary but I think it covers the manufacturing processes very well. There are pretty good summaries on the epidemiology and the toxicology studies. It also talks about the bonding of the agglomerates. These things do not break up under normal circumstances. You have to go to pretty significant mechanical forces to get these things to break up into smaller particles. Thank you very much.

Belsito's Team Meeting:

DR. BELSITO: Okay, Silica and Silicates. Now, folks, we've really got to concentrate on this because the Marks Group report's in public session, and we got to get ready to attack them.

Okay, so this is -- we got some pages here, information that was not in the book, unpublished data, and basically it was two human studies, 27 individuals each, exposed to 17 percent concentration of hydrated silica with negative sensitization.

And then we got a guinea pig sensitization study on hydrated silica -- the shortest study I've ever seen, or at least the shortest summary -- and this was 10 percent in distilled water with a challenge that induction from 1 to 20 percent, and that was on 10 animals, and that was negative.

And then we got a summary from the FDA on line just lots of data that I didn't think had added anything to the report.

And then we had a rather SASSI talk this morning, so hopefully you've heard more than you need to hear already today on silicates.

And so the question here is, what are we -- where are we going with this? And I thought probably, you know, safe as used, I sort of did agree with the comments this morning that we need to be very careful about the amorphous silica because I got like really confused reading the document as to where we're going.

And I guess the other questions I have are, how do we handle these prior reports from 2003 and 2005? Do we want to lump them now? Do we want to wait till 2018 when the first 2003 report comes up for re-review, and then lump them all together? Or where do we go with those? And table 10 was missing from my document.

SPEAKER: (off mike)

DR. BELSITO: Table 12 was where -- table 12 continued was where Table 10 was supposed to be, so --

MS. BECKER: Right. So table 12 continues -- started a page early.

B - SPEAKER: Microphone.

DR. BELSITO: Oh, so table 12 on page 78 is really table 10.

MS. BECKER: Correct.

DR. BELSITO: And table 12 continued belongs after belongs after table 12? Okay. Or is table 12 continued -- really Table 10? Which one is table --

SPEAKER: The first table 12 continued on page 78, the table --(off mike).

DR. BELSITO: Oh. So it's really not table 12 continued. Oh, okay, good. Well, that helped me out there. (Inaudible chatter) I thought I was Hebrew reading from right to left.

Okay, those are my comments. Curt and Paul?

DR. SNYDER: So all of that data, that other data has been added in?

MS. BECKER: Everything's in.

DR. SNYDER: That's everything?

MS. BECKER: That I have except for what just this little bit you got handed.

DR. LIEBLER: I would quite agree with the revision suggested in the staff, the presentation this morning, on clarifying the definition of the form to use and minimizing the emphasis on crystalline silica.

DR. BERGFELD: Minimizing or deleting?

DR. LIEBLER: Excuse me?

DR. BERGFELD: Minimizing or deleting.

DR. LIEBLER: Minimizing.

DR. BERGFELD: Do you think leaving it in leads to confusion?

DR. LIEBLER: No, I -- well, I got the impression that it's good to know that what is being discussed is not crystalline silica.

DR. BERGFELD: That will be really a very great delete.

DR. LIEBLER: Very brief, right, minimizing.

DR. BELSITO: And probably just summarizing that a) we're not talking about crystalline silica, and so that means things in the nature of silicosis, pneumoconiosis, those types of issues that people associate with silica are going away.

DR. LIEBLER: Exactly. But if you don't mention that, if you don't mention it's not crystalline silica, then people are going to get confused and asked why you're ignoring all that stuff.

DR. BERGFELD: But there are a lot of citations here that --(off mike).

DR. LIEBLER: Yeah. And I guess I had a question, in the older literature where it may not have been clear what form of silica was actually used in some of these older studies, and what effects are valued? Should those studies be included?

That's why I asked the question this morning, was there any milestone or change in manufacturing process that would have sort of invalidated earlier studies, because the material that was tested was no longer applicable to current cosmetic use. And it sounds like it's not that straightforward.

But where it's not clear that the material study was the material that is used in current cosmetic use, I think that stuff should be deleted.

MS. BECKER: Whenever I was unclear on whether it's crystalline or amorphous, I left it out. I only did think I could definitely say were amorphous from the test to this paper.

DR. BERGFELD: You have the fume silica. Fume silica, that would be one of --

MS. BECKER: If they called it fumed silica. If it says silica fume, I never saw that.

DR. BERGFELD: Okay, but --

MS. BECKER: But I saw fumed silica.

DR. SNYDER: That's all the tox data, is fumed siliar.

DR. BERGFELD: But that's different from the crystalline form, then.

MS. BECKER: I guess.

DR. BAILEY: I would recommend taking from the presentation this morning that in some detail the characterization and definition and so forth, and put that into the appropriate part of this report, because there is a huge amount of confusion. And your assessment will be for the synthetic amorphous silica. And I think you need to, in the discussion, strongly make that distinction and separate from the crystalline silica, because this is an area where there's so much confusion, and the terms used and, you know, questions about silicosis and, you know, being related to silicos used in cosmetics. That really needs to be clarified.

And your expectations need to be clarified that we're talking about, you know, that we're talking about the, you know, synthetic amorphous silica in the process.

DR. BELSITO: Right. But as Paul pointed out, you know, a lot of the studies, and I guess what really threw, you know, a monkey wrench into -- and again I think it's safe as used -- but I mean I think you want to present the correct data and not incorrect data that you have to argue against: Was the fumed silica versus silica fumed, and one is actually crystalline and not amorphous, and the other is amorphous.

DR. BAILEY: Right. Right, exactly.

DR. BELSITO: And so when we're referring a lot of the studies in here is a fumed silica which -- is that silica fumed or fumed silica? Is it amorphous, or is it crystalline?

And, you know, I don't -- you know, based upon that, I don't know how to proceed with this. Should we --

DR. HATHAWAY: Can I make a --

DR. BELSITO: Yeah. (Chatter -- inaudible)

DR. HATHAWAY: Unfortunately, there's different categories of amorphous silica. What's used in the cosmetics are synthetic amorphous silica, and there is the two processes, you know, the wet and the thermal that was described. There is also a whole bunch of other things that are called amorphous silica that typically contain a certain amount of crystalline silica. And so that adds to additional confusion. You have the diatomaceousers which contain a little bit to start with.

When they're calcine they contain a lot. And then you have on the other side of the other amorphous ones is silica fume, which is usually called an amorphous silica, but it contains a certain amount of crystalline silica.

So it presents a potential point of confusion, and we offered to work with -- I forget your name --

MS. BECKER: Lillian.

DR. HATHAWAY: Lillian -- you know, to try to come up with some, you know, perhaps a better way of presenting the characterization of the material, you know, early on in the report.

DR. SNYDER: I think that's a good idea.

DR. BELSITO: So should we table this --

DR. BERGFELD: Yeah.

DR. BELSITO: -- and ask Lillian to work with the SASSI -- but we don't want to get too sassy in the process, Lillian -- and go through and look at each of the references that are here and make sure that a) that when they're talking about fume silica, it's the amorphous and not the crystalline.

And then spoof up the document and have it come back to us with the notion that at least I'm comfortable, Paul and Curt, with the idea that this is going to be safe as used, but we want the information in the document to be what is actually used in cosmetics and not what is not used in cosmetics or --

Lillian, do you feel that you've already done that --

MS. BECKER: I --

DR. BELSITO: -- or were you confused by their presentation?

MS. BECKER: I was. That's one of the things that took me so long in getting started on this particular -- was going through and combing through all of that and figuring out what was amorphous and what was not.

DR. BELSITO: Okay.

MS. BECKER: And all I have to go on is what, you know, the writers wrote. And what the writers wrote I did quote in there. If they say colloidal, I put it in there; if they say silica so I'll put it in there so that I did not interpretation other than its amorphous or not.

So unless they know something I don't know about the papers, I don't think I can -- you know.

DR. BELSITO: Okay.

DR. BAILEY: (off mike) -- these are really editorial changes. I mean they may be more editorial than we're maybe used to, but I think if you feel comfortable with the, you know, conclusion, and working with SASSI folks to make these corrections and editorial changes, that, you know, we would -- I would recommend going ahead and giving your conclusion and moving the documents forward.

DR. BELSITO: Okay.

DR. BAILEY: With the idea that you'll have a chance to look at it, you know, with those editorials when corrected.

MS. BECKER: And then when we get through, it might be more clear --

DR. BELSITO: Okay.

MS. BECKER: -- without the --

DR. BELSITO: So, then, why don't -- well, then, the suggestion is we move forward, tentative final, safe as used.

Lillian will get together with the SASSI people for editorial corrections, and I guess I would like to see done what was done for the cyclomethicone report where there are comments that we should delete something that is currently in here. If they could keep it, then just underline that whole paragraph with a comment that, yeah, in review we're recommending this be deleted because in reality it was not amorphous silica, and then we can say, oh, okay. You know, rather than just having a whole bunch of material disappear from this document and us now knowing why it disappeared.

DR. BERGFELD: Well, can I offer another suggestion that maybe, when they're working on their draft, that they do that? But then they give us the second draft of deleting all of that, because I think it's going to be confusing with all that fume stuff in there. It's everywhere.

DR. SNYDER: But isn't the fume silica the pyrogenic silica which is one of the forms of a --

DR. BERGFELD: Well, maybe. You did say, Dr. Hathaway, that some of that had a high crystalline level.

DR. SNYDER: That's silica fume.

DR. BERGFELD: I know. I know. I know, but --

DR. HATHAWAY: Unfortunately, the two terms are very similar. That's why, you know, and the editorial changes we would strongly recommend that you use the term "pyrogenic" instead of fume silica. We're trying to do that in the industry to, you know, avoid that confusion.

DR. ANDERSEN: Don, I think with due respect to the industry input that we've received today, I'm not prepared to turn this report over to industry for writing it.

DR. BELSITO: Well, I don't think for writing, but for comment that we can review.

DR. ANDERSEN: Comment can be made by any interested party when the tentative document is issued for public review. If we get some further input, I'd love to receive that.

DR. BELSITO: Okay.

DR. ANDERSEN: But there is nothing that I've heard in terms of fundamental flaws that says this should stop. Should we include up front maybe a further glossary that explains to the reader that some of the terminology you're going to be seeing may look strange, and, in fact, the current preferred term for fume silica is pyrogenic silica. We can put that up front so that the explanation is provided.

But if the author of the published study called it fume silica, we can't recreate what was said in that published study. The fact that we think that's pyrogenic silica, you can in fact state positively that we think it is.

DR. BELSITO: Okay.

DR. ANDERSEN: That's a fine way to deal with it. But I don't -- I'm not hearing anything that says that there is a fundamental flaw in this document. The data that are there don't raise particularly any safety issues. It is axiomatic that we must be clear that this is not a safety assessment of crystalline silica.

DR. BELSITO: Mm-hmm.

DR. ANDERSEN: So however we do that, you know, it's going to be like teaching high school history: Tell 'em what you're going to tell 'em; tell 'em and tell 'em what you told 'em. If we don't say it that many times, we will not have done our job. So we can look at it from that point of emphasis, but unless there is a study that's included in here that is known to be crystalline silica and shouldn't be in there, there's nothing to deal with here.

DR. BELSITO: Okay. So then we're not going to make any changes, except to perhaps a little stronger emphasis in the --

DR. SNYDER: Prologue.

DR. ANDERSEN: Except to be responsive to Dan Liebler's --

DR. BELSITO: Right.

DR. ANDERSEN: -- point about minimizing the crystalline silica part, that I don't have a problem with that.

DR. BELSITO: Mm-hmm.

DR. ANDERSEN: But that is indeed, as John pointed out, it's editorial. And that's just a level of finessing this that is important. I mean I think we heard clearly this morning that to any reader they better see clearly the focus of this is away from crystalline silica.

DR. BELSITO: Okay.

DR. ANDERSEN: I think we're very close to that anyway, but a little more emphasis can't hurt.

DR. BAILEY: I mean I -- from the industry's perspective, I would like to see this document, you know, set sort of a framework for future use of terms, and understanding of what is what. A glossary would certainly do that.

DR. BELSITO: Okay, sure.

DR. ANDERSEN: It could help.

DR. LIEBLER: You had a figure 1 that's sort of like what I called the silica family tree --

DR. ANDERSEN: Right.

DR. LIEBLER: -- earlier in this morning's presentation. And I think, you know, maybe sitting here with a couple cups of coffee and listening to it here to get off to the second time made it more clear to me that there were some nice distinctions that emerged from this morning's presentation that I just didn't get first time reading it. And that might have been me, not you, but I think it's worth making the point about pyrogenic silica being -- also being called in the literature "fumed silica," and how that can lead to confusion of that material with "silica fume."

And if that can be briefly explained in the introductory material so that it allows, then, the reader to go to the original language in the literature report and not be baffled.

DR. BELSITO: Right. Okay.

DR. ANDERSEN: That works.

SPEAKER: That we know how to do.

DR. BELSITO: Okay. And then just to get back to my prior point about we have two prior reports out, the 2003, 2005, do we want to collapse all of those ingredients into this report? And then a final point is in one of those two our conclusion was when formulated not to be irritating. In this series of reports we really don't have any data to suggest that these materials are in fact irritating when used.

But now this will be the third silica document. One I think was safe as used, and one had a conclusion that -- that potassium, sodium, and silicate is the one that says "when formulated to avoid irritation." And then the other one was just "are safe as used in cosmetic products."

DR. BERGFELD: You could -- you could handle that with "should not be irritating in the product." I mean like we did before.

DR. BELSITO: I understand that, but my point, Wilma, is that in this current document --

DR. BERGFELD: Yeah.

DR. BELSITO: -- with these current ingredients, we have no data to suggest that irritation is, in fact, the problem. And, in fact, the irritation that we had --

MS. BECKER: Was only with the potassium study only.

DR. SNYDER: Sodium potassium.

DR. BELSITO: -- was only with potassium, sodium --

DR. BERGFELD: Silica.

DR. BELSITO: -- metasilicate and sodium silicate.

DR. BERGFELD: Which was the --

DR. BELSITO: And that was, you know, I think because we had data as in all cases where, you know, 100 percent there was some irritation or something, and this was back when we -- I don't know what we were doing -- but so if we don't combine these documents, then we're going to have two reports on silicates that say safe as used, and one that says safe as used when formulated not to be irritating.

And it's just, to me, if I were not on this panel, and I'm looking, okay, so what's the difference between calcium and sodium silicate, and why can one be safe as used and one only be safe as used when it's formulated not to be irritating?

DR. ANDERSEN: Well, I think that the answer is not in this report, but the answer is in fixing the other report. The only data that suggested a concern was actually sodium metasilicate.

DR. BELSITO: Right.

DR. ANDERSEN: And the conclusion could have focused on that ingredient in the earlier report; we just didn't do that. But all of the other simple salts were not irritating, continuing the pattern. So I don't think that you lose anything by not perpetuating the problem here but rather when we come back to the previous report fixing it. Or if industry is particularly concerned, they can suggest an amendment as needed to the earlier safety assessment.

DR. BELSITO: Okay.

DR. HATHAWAY: I might be able to add a little bit of clarification. The sodium metasilicate is a very alkaline material, and that may be the reason why in some formulations, if it's not very careful to adjust the overall pH of the product, you could end up with an irritating situation. We really didn't comment on that; we focused really only on the synthetic amorphous silica things, but that's probably why it was there in the older ones.

DR. BERGFELD: And our summary from the older document mentions that.

DR. BELSITO: Okay, so we're going ahead with the safe as used. We're going to do -- clean just a little bit, strengthen the introduction to clarify exactly what we're looking at, the fume versus fumed silicate -- silicate fumes, and, I gather from what Alan said, we're not going to add in the ingredients from the reports we previously did, we're worry for the 2018 people.

So you'll remember this discussion, Wilma, in 2018.

DR. BERGFELD: Me, too.

Marks' Team Meeting:

DR. MARKS: Okay. Let's move on. We've got another non-contentious ingredient named silica.

SPEAKER: Lillian will come up.

DR. SLAGA: I recommend we table this.

DR. MARKS: Okay.

DR. HILL: And I second that.

DR. MARKS: Let me see -- and I'm the one that --

DR. SLAGA: It's too complicated. Unless all these things are changed and number two, I would like to see us relook at -- even if informal -- the other two that we -- has been approved in the past.

DR. MARKS: Well, one of --

MS. BECKER: (off mike)

DR. MARKS: Go ahead, Lillian.

DR. SLAGA: Why?

MS. BECKER: I'm just trying to catch up, so I think I'm just going to sit in while I listen here.

DR. SLAGA: Because I think somewhere (off mike).

DR. SHANK: But they're already finished.

DR. MARKS: No. Not -- actually nothing was said. Basically the suggestion was made that this be tabled so we can go ahead and integrate the presentation we heard this morning. Thank you. And then also look at the two previous safety assessments that were done and, in fact, one of the -- the potential suggestion --

DR. SLAGA: Well, even Belsito wanted them to look at those two. I mean --

DR. MARKS: Yeah.

DR. SLAGA: -- because that'll be brought out tomorrow, I'm sure.

DR. MARKS: Well, one of the potential tacts I thought was we just reopen the old safety assessments and group all of this together.

DR. SLAGA: That could be wise.

DR. MARKS: And that could be -- so it could be tabled with that idea also as to consider do we group all -- all of the safety assessments.

DR. SLAGA: Who's presenting this one?

DR. MARKS: I'm tomorrow. So it will be easy if it's tabled. But I should think we need to know what we want other than obviously integrating the data we've heard today.

MS. BECKER: Well, of the data you heard today, the papers that they talked about are already integrated into the report. I got the information in time to integrate it for you guys. So you've already read everything they've given us.

DR. SLAGA: Oh, okay. It's been changed over what they were --

MS. BECKER: Right, right.

DR. SLAGA: Oh, okay.

MS. BECKER: Yes. They gave me the stuff -- I already -- I stayed up late at night putting all this stuff in so you guys could have it. You have it.

DR. SHANK: You made it clear about the crystalline versus amorphous. Is that what you're talking about?

MS. BECKER: Um.

DR. SLAGA: I didn't think that was --

DR. MARKS: Yeah, it's in the introduction -- the second paragraph. It's very clear. There are two categories -- crystalline and amorphous -- and only the amorphous ones are used in cosmetics. That's page one.

DR. HATHAWAY: Part of the problem is that a lot of amorphous forms are not used. It's really only the synthetic amorphous forms. And -- you know -- we would appreciate it if even though the data is in there, particularly the section on the silicas -- you know -- I think it could be clarified so that it would be a lot less confusing to other people. It may not affect your safety assessment, but since it would be a public document -- you know -- we would like it to be -- you know -- as straight forward and easy for -- you know -- someone else to read and understand it.

MS. BECKER: When I was going through all the papers in many papers it is very difficult to figure out which type of silica it was and I gave their -- the author's description of the silica as given and that is clear as I can make it. If you know something I don't as in -- you know -- we know this guy only worked on this type of silica, which is never used, we could -- you know --

DR. SLAGA: We probably don't know that.

MS. BECKER: We don't as far as I know.

DR. SLAGA: I would based on the (off mike).

DR. MARKS: (off mike)

MS. BECKER: But, I used the description of the authors provided.

DR. HATHAWAY: No, I understand that. The confusion comes as I mentioned this morning. This one amorphous silica that's formed by melting crystalline silica -- you know -- ends up forming a solid object, you know. Maybe it doesn't become a glass like this, but it's a type of glass. So it's not really relevant to this and then the confusion between silica fume, which is considered another amorphous form but has a certain amount of crystalline silica in it and the pyrogenic silica -- that a synonym is fumed silica -- you know there's a problem there. You know we would just like -- we would very much appreciate it if -- you know -- all of these terminologies were clarified so there would be not confusion on the part of an outsider reader and -- you know -- we're willing to work with you to try to get that squared away.

SPEAKER: We can do that. We can help.

MS. BECKER: Yeah, because as far as -- my information -- with the information I have, it's as clear as I can make it. So if you've got better information --

DR. SLAGA: Some of the publications won't be clear. That's -- I think that's the point you make.

MS. BECKER: Yes.

DR. ANSELL: Well, a lot of them do have scriptors -- precipitated study, aerosols, silica, undescribed, (off mike) silica. Perhaps we could clarify --

DR. HATHAWAY: No. There's no question the revision is a lot better than the -- than the initial draft, but there's still, we feel, could be improved to avoid -- you know -- confusion by people reading it.

SPEAKER: Well, I --

DR. ANSELL: Could you identify which of these are the cosmetic silicas as opposed to the (off mike) silicas?

DR. HATHAWAY: Correct. Yeah.

DR. SHANK: Inclusion of that flow sheet that you gave us this morning would be helpful.

DR. MARKS: It is actually in there.

MS. BECKER: It is in there.

DR. MARKS: Page 62. Yeah. It's page 62.

DR. SHANK: I forgot that.

DR. MARKS: Yeah. It's in there which -- so I think we're -- if we decide to issue a tentative report, that gives the opportunity for you to comment and do some of these suggestions you have.

DR. HATHAWAY: I mean -- yeah. I mean if you'd be willing to -- you know -- have us work with you --

MS. BECKER: Um-hmm. Sure.

DR. HATHAWAY: I think the section on describing the forms of silica is an area that we would like to see changed.

DR. MARKS: Sure.

DR. HATHAWAY: And maybe some introduction on the inhalation intratracheal thing on particle size -- you know -- just to clarify. I mean you have it in there, but it was right at the very beginning -- you know -- that kind of prefacing all of these studies, even though many of the studies may not have specifically referenced particle size -- particularly some of the older ones.

DR. MARKS: And sometimes that appears in the discussion and the discussion at this point hasn't actually been written, so these nuances are often included in the discussion to put it in perspective. So that can -- all that can be done.

MS. BECKER: Yeah. The inhalation boilerplate is in there.

DR. MARKS: Yeah.

DR. HATHAWAY: On the form (off mike) size?

DR. MARKS: Yes.

DR. HATHAWAY: Okay.

SPEAKER: Let's help through the discussion focus on the most relevant studies versus (off mike).

SPEAKER: Dr. Marks?

DR. MARKS: Yes.

SPEAKER: May I make an administrative request here --

DR. MARKS: Sure.

SPEAKER: -- which is that we do have an administrative process which includes a time period during which comments are solicited and welcome and we really would like people to submit valuable comments -- to submit them during that time frame, not afterwards. Because that really messes up our process and it doesn't allow us to incorporate the changes in a timely way so that you can see them before the panel meeting and the panel can see them.

DR. MARKS: Right. And that's a 60 day time period, so we'll have plenty of --

SPEAKER: Well, okay -- wait -- yeah -- we --

DR. MARKS: -- plenty of time to add these wording. We haven't even seen the discussion on this. We are basically today to decide --

SPEAKER: Okay.

DR. MARKS: -- one, do we want to issue a tentative safety assessment.

DR. PAVLICH: As we understood the process when Dr. Andersen visited, we were given the opportunity to look at the first draft of the scientific review and we sent in our comments and then he told me that we probably wouldn't have a chance to get those comments incorporated into the review before this meeting and therefore just to come and give our presentation. So that was our -- that's how we understood the process. So -- I mean -- we had these prepared last week, but we -- our understanding was that it wouldn't make it any difference if we sent them in early or not.

SPEAKER: Not the case (off mike).

DR. PAVLICH: Not the case.

DR. MARKS: Okay.

DR. PAVLICH: We stand corrected.

DR. MARKS: So, Ron, Ron and Tom -- Ron, Tom and Ron -- whichever way I want to go is -- do you want to move this forward to make a conclusion on these ingredients as a cosmetic ingredient and keep it as such? Do you want to group this with the other reviews (off mike)?

DR. SLAGA: Well, based on a lot of changes have already made, there's -- we can do it with the others later. We don't have to deal with them (off mike).

SPEAKER: She can't hear you.

DR. SLAGA: I think we have to deal with this --

DR. MARKS: Okay.

DR. SLAGA: -- and right now, I don't think we have to based on what we have already heard that we have to deal with the other two that have been already out in literature.

DR. MARKS: Is there -- so can the conclusion be safe?

DR. SHANK: Yes.

DR. MARKS: Okay.

DR. SHANK: With one question. The iron -- the which is it called -- aluminum iron silicate. We have almost no data on any of the metal silicates. But calcium silicate, sodium silicate -- that doesn't bother me. But the adding aluminum iron -- especially if it's inhaled with a high oxygen content of the lung -- the iron atom could produce oxidative damage which would not be expected by any of the other silicates. So I would not include aluminum iron silicate without data. The others I can add. That's the only change.

DR. MARKS: So that would be insufficient?

DR. SHANK: Insufficient for -- well, these are add-ons, aren't they or whatever?

DR. MARKS: No.

SPEAKER: No. It's the original assessment.

DR. SHANK: So it would be insufficient for the aluminum iron silicate and you'd need inhalation data unless -- you could say since it's not respirable.

DR. HATHAWAY: Well, I don't think any of our member companies produce that compound, so I don't have any information.

DR. SHANK: Okay. We had no data on it. But if it's -- if it's not respirable, then it's not a problem.

SPEAKER: I have no idea what the (off mike) for that is.

DR. SHANK: But, since we have no data on it, we would need some data.

SPEAKER: That's a good compromise.

DR. MARKS: So we'll move that this be a tentative safety assessment and it's these ingredients are safe with the exception of aluminum iron silicates, which would be insufficient data --

DR. SHANK: Inhalation needed.

DR. MARKS: Yeah. We need the inhalation.

DR. SLAGA: Unless that can be shown --

DR. SHANK: Well --

DR. MARKS: Yeah.

DR. SHANK: -- if it can show it's not inhaled then --

SPEAKER: Unless someone shows (off mike).

DR. MARKS: So we'll issue a tentative safety --

DR. HILL: And I'm answering a question while you're writing sort of from this morning is -- and I'm thinking in particular of hairspray formulations where there -- the amounts are small anyway. I understood you to say that as manufactured -- according to your knowledge -- there are large enough aggregates that even assuming that whatever

liquid accompanied the droplets evaporated before somebody inhales this, that the particle sizes are still too large to go any farther than the trachea. So I --

DR. HATHAWAY: Correct. When they're -- when they're in a solution -- whether it's aqueous or a combination of other solvents or whatever -- it's not going to disaggregate.

DR. HILL: So then my question became at least based on your knowledge of the companies that are manufacturing this stuff, that are in products available to Americans at least, that there are no nanosize particles -- anything smaller than four microns that are fines -- what we always called fines working with silica in the lab -- in products as they are manufactured, but the finished products -- the hairsprays and such.

DR. HATHAWAY: We ran it by -- you know -- the companies on both sides of the Atlantic. Initially we had down there 16 to 100 microns because that's pretty much what all the people on this side had and they recommended we drop it to 10, because I guess they must have some products that are down closer to 10.

DR. HILL: Okay. Okay.

DR. HATHAWAY: But -- you know -- we checked with -- you know -- the eight companies are the same companies on both sides of the Atlantic. They may have different plants and have -- you know -- slightly different product mix, so we certainly checked with all of the European and the North American manufacturers.

MS. BECKER: Could we get a letter or memo saying that so I can put it in the document?

DR. PAVLICH: It's in the -- it's in our summary. Ten to 100 was quoted in that summary.

MS. BECKER: Okay. Thank you.

DR. MARKS: Okay. Any other comments? We'll issue -- we will move -- I will move since I'm the one that will be presenting this -- issue a tentative safety assessment with a finding that aluminum magnesium (off mike) aluminum calcium, sodium silicate, hydrated silica and a sodium potassium aluminum silicate are safe for use in cosmetic ingredients. And that the aluminum iron silicates -- there's insufficient data and we need the inhalation data to decide whether that's safe. And, Ron, if there's any discussion --

DR. SHANK: Unless it's in the 10 to the 100 --

DR. MARKS: Well, that would be essentially the --

DR. ANSELL: Yeah, that would be formulated to be nonrespirable.

SPEAKER: Do we have anything you want in the discussion other than inhalation?

DR. SHANK: Did Lillian catch what we just said?

DR. ANSELL: And formulated to be nonrespirable.

MS. BECKER: Yes. Writing it down.

DR. MARKS: And we can use the same words as they used in the 2004 report.

SPEAKER: Just finishing silica.

MS. BECKER: For which?

DR. SHANK: In the discussion for this document, you can just use the discussion on inhalation with cosmetic sprays --

MS. BECKER: Okay.

DR. SHANK: -- that we used in 2004 --

MS. BECKER: Okay.

DR. SHANK: -- which was the potassium and (off mike).

MS. BECKER: Alright. That works for me.

DR. MARKS: Okay. Any other?

SPEAKER: Anything else?

DR. HATHAWAY: Just to say that although I mentioned hairspray, face powders is in here. So this is a totally theoretical question.

SPEAKER: Alright.

DR. MARKS: Not really. Thank you very much for your patience and comments.

SPEAKER: Thank you.

SPEAKER: Thank you.

MS. BECKER: Thank you.

SPEAKER: Very helpful.

DR. MARKS: This morning and also right now. Thank you.

DR. PAVLICH: Good. Well thank you for having us.

Full Panel Meeting:

DR. BERGFELD: We're going to move forward then. This (off mike) this table to answer the questions that have been so stated, and we'll be moving on to the next group, Dr. Marks presenting on silica and silicates.

DR. MARKS: In the March meeting of the CIR Panel, a scientific literature review was announced, and we're now seeing the draft report on silica, alumina magnesium metasilicate, aluminum calcium sodium silicate, aluminio-iron silicates, hydrated silica, sodium potassium aluminosilicate. And we had the presentation yesterday by the SASSI group clarifying the difference between synthetic amorphous silica, which is used in cosmetics and other forms of silica, and based on the information that we reviewed, we move to issue a tentative safety assessment that has the ingredients safe with the exception of aluminum iron silicates. We move that that be insufficient data, because of concern about inhalation toxicity.

DR. SLAGA: Unless it's (off mike).

DR. MARKS: Ron can -- well, that would be the inhalation data. If it's not respirable, then it's not an issue.

DR. BERGFELD: Any other -- that's a motion?

DR. MARKS: Yes.

DR. BERGFELD: And there's no other comment on the motion? Second? Second, Ron? Discussion?

DR. BELSITO: Respirable? We have that boilerplate. How would it be respirable?

DR. MARKS: We don't know. We can consider that it's not.

DR. SHANK: I worry about the -- or I have concern about the iron atom going into the lung, high-oxygen environment. There could be oxidative damage, which would not expect that the other silicates --

DR. BELSITO: But I --

DR. SHANK: If not, we can say this is formulated (off mike). That takes care of the issue. But we don't have that information.

DR. BELSITO: I thought the information we have was that cosmetic formulations -- the particle size was such that it's in a pump or a spray it's not respirable.

DR. SHANK: Okay, but this one doesn't have a stated use, does it?

DR. BELSITO: But how would it be used as an aerosol other than as a hairspray?

DR. SHANK: Don't know. Lack of information is not proof of safety.

DR. BELSITO: But -- then I just --

DR. BERGFELD: Alan?

DR. ANDERSEN: We did have the information yesterday from the synthetic amorphous silica group that said the particle size of the amorphous silica material is between 10 and 100 microns in diameter, so independent of what happens to it after that, the particle size as produced by the suppliers is already of a size to be not respirable.

DR. BELSITO: Correct.

DR. ANDERSEN: From that point, it doesn't matter what formulation it goes into. Not much can happen beyond that, and in order to conduct the inhalation toxicity studies that were described, further unnatural reduction particle size had to be done, but that doesn't represent what's actually on the market from the suppliers. So, we could rely on that information that was presented to make the assertion that in fact the panel does not expect that these particles are respirable and put that burden on the industry for all of the amorphous silica, including the iron one. So, it would be a way to assert the panel's expectation of non-respirable.

DR. BERGFELD: So, you're going to amend?

DR. MARKS: I'll retract the previous motion with that clarification, and that being captured in the discussion so that all these silica cosmetic ingredients would be safe and that we issue a tentative safety assessment of that conclusion.

DR. BELSITO: Second.

DR. BERGFELD: Second. And with the assumption that the discussion will take the place or support your worry.

DR. MARKS: Yeah.

DR. BERGFELD: Okay. Any other discussion? John?

DR. BAILEY: Yeah, at yesterday's team meeting I emphasized the importance of stating clearly in this document the synthetic amorphous silica as the material that's used in cosmetics, because we have a lot of confusion inquiries coming in that rather it's crystal and we're amorphous and we'd like to be able to use this document to clear that up both for people who have concerns in the public but also for the users of the ingredients so that that's clearly communicated to them what they're supposed to do.

DR. BERGFELD: I think that I sat on Don Belsito's team and he discussed that and which to do with that, did you not?

DR. BELSITO: Yeah, a very strong statement up front in the introduction going over basically that slide of silica production and where we are and that this is not crystal and then the amorphous, so I think Dan had -- Did you actually beef up your introduction, or --

DR. LIEBLER: I provided comments.

DR. BELSITO: Right.

DR. LIEBLER: But I think it's most important to -- because some of the original literature refers to silica forms -- for example, as fume silica -- and that there's a preferred term now, pyrogenic silica, for that, but there needs to be a very clear sort of glossary in the introduction section to provide the reader with some guidance as they go forward in the report, because we did have some discussion about whether to change in the body of the report reference to fume silica -- change that to pyrogenic -- but that would be essentially, as Alan pointed out, replacing -- revising the literature inappropriately, and I agree with that, so a glossary up front that clarifies the terminology for names and points out where you're going to have confusion between silica fume and fume silica, for example.

DR. BERGFELD: Paul, any comment? Greg? Coming over here. Don? Ron? Rob? Jim? Is there any other comments? Okay. Motion has been placed that this ingredient is safe and discussant points have been added, so all those in favor please raise your hand for a safe review. Thank you very much. It's a unanimous vote.

September 24-25, 2009

Belsito's Team Meeting:

DR. BELSITO: So now we get into the silica and the silicates (off mike). Okay, so where are we here? Silicates. Okay. So, we got -- is this a handout from today from Sassi?

MS. BECKER: You got that in the e-mail.

DR. BELSITO: In the e-mail. Oh, I printed out an e-mail. Okay.

MS. BECKER: Yes.

DR. BELSITO: I must have addressed it. Okay. I thought, Lillian, you did a great job and I really thought that Figure 1 and 2 were really great in this report. And I think it really addressed concerns of our team, at least particularly Dan's concern of getting everything up front and making it clear. I like the way you've boxed that out in Figure 1.

DR. LIEBLER: Yeah.

DR. BELSITO: It was really a superb way of handling that to show exactly where we're focusing.

DR. LIEBLER: One little note on that on Figure 1 -- so I completely echo Don's praise for your work on this -- but one little thing I would change is under the box where you've got -- where it says the types of silica in this safety assessment, and it's got a little box around that -- that that actually kind of hides that because everything else in the figure has a box around it. And that's actually a message that you want to stand out and putting the box around it makes it blend in. So what I would say is take the box out of it and then use a bigger font and italicize it just so it --

DR. BELSITO: And put it into the box maybe even.

DR. LIEBLER: Or right under the box or, yeah, lower the box a little bit and stick that in the box. Yeah, that's a good idea.

MS. BECKER: Yeah. That's what I'm drawing right now actually.

DR. LIEBLER: Okay. But that's just a tweak. It's very nice. Huge improvement.

DR. BELSITO: On page 17, under parenteral silica one, two, three, four, five, six lines down, it says lymphocytes were less numerous and new.

MS. BECKER: Okay, few. Probably -- yeah, few. Probably something (off mike) said.

DR. BELSITO: So if it's less numerous and few, then you don't even need few.

MS. BECKER: Yeah.

DR. BELSITO: Just less numerous.

MS. BECKER: So we will check that.

DR. KLAASSEN: Probably don't need numerous either. There were lots of lymphocytes.

MS. BECKER: There's some pretty weird wording on some of these.

DR. BELSITO: Page 29. Things were moved around so perhaps I missed it, but in the prior document there was an ECETOC 2006 report of two subchronic oral and toxicity studies that I couldn't find again.

MS. BECKER: If I remember correctly, a couple of short-term -- I'm sorry, long-term and chronic got moved around just because of dates, but I don't -- did you check to see if it's just in a different time section?

DR. BELSITO: I tried to do that and I couldn't find it, but, I mean, it's entirely possible. The reference though is gone, at least as an ECETOC 2006 reference, so I'm wondering if someone recommended it be deleted or was it, in fact, maybe published under a different title?

DR. BRESLAWEC: Here's ECETOC 2006 on 31.

MS. BECKER: There was also a couple that were thought to be duplicates of the other large document I had and we picked one or the other.

DR. BELSITO: Okay.

MS. BECKER: So that might be --

DR. BELSITO: So it may be --

MS. BECKER: It might be under UNEP instead.

DR. BELSITO: Okay. But then that ECETOC 2006 reference doesn't occur in your references.

MS. BECKER: I see what you're saying.

DR. BRESLAWEC: If you look at the reference there's nothing that says ECETOC.

DR. BELSITO: And there are some ECETOC on page 31 that refers to some 2006 unpublished studies, which are different from the studies that I was talking about.

MS. BECKER: European Centre for Ecotoxicology and Toxicology of Chemicals.

DR. BELSITO: Okay.

MS. BECKER: On page 57. It's in the references.

DR. BELSITO: There it is. ECETOC 2006. Sorry, I stand corrected.

Okay. On page 35, the fifth line up the bottom, starting from the line above that it says although there was a trend of more frequent incidence in those exposed to pyrogenic silica, it was obscured in some control animals. Interstitial fibrosis was associated with yadda, yadda, yadda. And some of the rats of the control treatment groups, although there was a trend to more frequent incidence in those exposed, but was obscured in some control animals. I'm assuming it wasn't significant because it was seen in control animals or --

MS. BECKER: If I remember correctly, yes.

DR. BELSITO: I just think that needs to be stated a little bit more clearly.

MS. BECKER: You got it.

DR. BELSITO: Page 54, the third paragraph, silica subcutaneously instilled in humans. Next sentence, the cells --

MS. BECKER: I'm sorry?

DR. BELSITO: -- invested blood vessels. Invaded blood vessels?

MS. BECKER: Page 54?

DR. BELSITO: Page 54.

MS. BECKER: Third paragraph?

DR. BELSITO: From the bottom.

MS. BECKER: Oh, sorry.

DR. BELSITO: Silica subcutaneously instilled in humans caused granulomatous inflammation with seven days and persisted for months. The cells invaded blood vessels?

MS. BECKER: That was --

DR. BELSITO: Invaded blood vessels?

MS. BECKER: Something like that would have been stolen wording. Yes, that was wording from Epstein 63. That's 47 and that would have been his wording. That's not something I would have picked up, but I try not to interpret too much. Is that 47? Epstein 63.

DR. LIEBLER: Just strike the whole sentence. It doesn't add anything.

MS. BECKER: Okay.

DR. BELSITO: Okay. In our conclusion, do we really need to isolate aluminum iron silicates?

MS. BECKER: That was Dr. Shank and his concern about the iron.

DR. BELSITO: I understand and I remember the discussion, but we decided that it wasn't going to be (off mike) even in the current form that it was used. So do we need to put that in the conclusion or just the discussion? I mean, I think, you know, its ingredients and practice of use in concentration as described in the safety assessment is sufficient. If there's any concern that could go in the discussion that the size of these particles, irrespective of how they would be used that was captured in the minutes, would not be respirable.

Beyond that, we know that the way pumps and sprays are formulated it wouldn't be respirable either. But as Alan pointed out at the last meeting, you literally would have to break down the silicates in order to make them of a size where they would be respirable. So, taking that out and putting it into the conclusion I think is a bit much.

MS. BECKER: Okay.

DR. BELSITO: I would just move that to the discussion if there's any concern at all.

DR. LIEBLER: So simply in the conclusion --

MS. BECKER: Just the first sentence.

DR. LIEBLER: -- just use the first sentence and then add aluminum iron silicates to the first sentence.

DR. BELSITO: Exactly.

MS. BECKER: Got it.

DR. BELSITO: The last thing that I couldn't find and maybe you can tell me where it was is -- and maybe it was decided to get rid of it -- but in the old document there was a statement about natural silica levels in rabbits. And I couldn't find where that was moved to, but the reference was retained.

MS. BECKER: Do you have the reference offhand?

DR. BELSITO: Yes, Ammon and Moan, 1959.

MS. BECKER: Ammon with an A?

DR. BELSITO: A-M-M-O-N.

MS. BECKER: I think that was marked as not necessary.

DR. BELSITO: I would agree that it's not necessary. Then we just need to delete the reference if it's not in the document. I mean, just check because -- I mean, you could just do a quick word search and see if it pops up someplace in the document other than the references.

MS. BECKER: Okay. That's going to be my major task this weekend actually.

DR. BELSITO: I hope not this weekend.

MS. BECKER: Oh, yeah.

DR. BELSITO: I think that's all that I had. So before we address the Sassi comments, any other comments?

DR. LIEBLER: Page 2 and 3, I recommend a couple of additional tweaks. Just moving sections to make the presentation more logical in terms of the flow.

So, on top of page 2, you have Chemistry, major heading, then subhead Definition and Structure, and then Amorphous versus Crystalline Silica. You have two paragraphs. Then you've got Silica, which is really the very most introductory information about silica. And I suggested moving that stuff there that's subtitled Silica, beginning with the CAS Number 7631, all the way through the top of the next page where it says, "The current terminology for silicon dioxide fumed is pyrogenic silica." That whole chunk, move it up between Definition and Structure and Amorphous versus Crystalline Silica. And I pointed -- I drew it on my copy for you.

MS. BECKER: Okay. All right. We're changing a lot of things as CIR, but normally we keep all of the definitions of all the ingredients together. Would that -- I'm just asking if that -- separating silica out separately from the aluminum magnesium, metasilicate, et cetera, would that be confusing?

DR. LIEBLER: I don't think so because the way you have it now you begin by talking about amorphous versus crystalline silica. And then at the bottom of page 2, you start out by explaining what silica is. It seems like you should start out by explaining what silica is and then get into the distinction between amorphous versus crystalline. It just seems more logical to me.

MS. BECKER: Okay.

DR. LIEBLER: And so you can move that section up to the top. And then you also have, at the bottom of page 3, you have the section on hydrated silica. That can go right after amorphous versus crystalline silica. And then you get into the aluminum magnesium salts and the silicates.

MS. BECKER: Okay.

DR. LIEBLER: And so that way you're doing pure silica first, then the salts, to just introduce the chemistry.

MS. BECKER: Okay.

DR. BELSITO: Except I guess the only issue that I'd have with that, Dan, is that we're doing -- you know, we're looking only at the amorphous. So then you would have amorphous and then you'd mix in amorphous with crystalline and then go back to the amorphous forms. That could be confusing. So that I guess if you wanted to move things around would be to move the amorphous and crystalline to the end of the whole thing and list the things that we're discussing first and then making the point of the difference between amorphous and crystalline at the end.

MS. BECKER: That would be more my inclination, but.

DR. LIEBLER: So, instead of moving the things I moved, just take amorphous versus crystalline and move it to the end?

DR. BELSITO: Yes.

DR. LIEBLER: I'm fine with that. That accomplishes the same thing. I just thought that you have amorphous versus crystalline at the top of the description of all the silica and silicates and it was premature to address that at that point. So, Don's suggestion takes care of that as well and I agree with it.

MS. BECKER: Okay.

DR. SNYDER: I had some issues with the nomenclature again. It's just really confusing because on page 5 we introduce silica gel and precipitated silica for the first time. And then on page 6 we introduce colloidal silica. And on page 8 we bring in the sodium metasilicate, hydrated silica, and silica solution. So I was a little confused as to where those all --

DR. LIEBLER: So under hydrated silica, Lillian has these bullets of synonyms, and silica gel and precipitated silica are listed there. So the reader will have encountered those definitions before they got to where you're concerned about.

MS. BECKER: Right.

DR. LIEBLER: And colloidal silica, is that one here?

DR. SNYDER: Yeah, page 6.

DR. LIEBLER: Page 6.

DR. SNYDER: On the third paragraph on down, silica sols, colloidal silica.

DR. LIEBLER: Does colloidal fall under one of these? Lillian, do you know?

MS. BECKER: I thought it was under hydrate.

DR. LIEBLER: I want to double-check that. If it can be defined there, that's a good place to put it if that's correct.

MS. BECKER: The issue was that through the literature the naming conventions are not consistent. And unless they gave me something that said I can identify it as exactly what we have as our definition, I used the terminology of the author.

DR. LIEBLER: So in Table 1 with the box around the forms that are defined in the safety assessment on page 61, you have silica gel or colloidal silica.

MS. BECKER: Right.

DR. LIEBLER: So the reader will have seen this figure at that point. It's just that colloidal silica isn't listed under the bullets that you have on pages 2 and 3.

MS. BECKER: Right. Yeah, and what I just explained is also in the introduction that I did not guess what the authors were trying to say.

DR. LIEBLER: Okay.

MS. BECKER: Unless they gave me real evidence.

DR. LIEBLER: Right.

DR. BELSITO: So colloidal silica is silica gel?

MS. BECKER: Yes.

DR. BELSITO: And silica gel is hydrated silica?

MS. BECKER: Pretty much.

DR. LIEBLER: Right.

DR. BRESLAWEC: So on page 3, you said include that in the bullets there?

DR. BELSITO: Under hydrated silica.

DR. LIEBLER: And colloidal silica.

MS. BECKER: So that -- well, okay, but that's another reference, so that would be slightly different.

DR. BELSITO: But you could add it just so it's clear and just put that reference so we know where each of them falls.

DR. LIEBLER: I mean, there must have been a basis for in Figure 1 including colloidal silica with silica gel.

MS. BECKER: Right. Right.

DR. LIEBLER: So that would presumably be the same reference.

MS. BECKER: Yes. That's what ARTS did. Yes.

DR. LIEBLER: Okay.

DR. SNYDER: And then there's in the nomenclature you get all the way to page 19 and we start talking about ultra fine and then fine silica. And we haven't defined that (off mike).

MS. BECKER: And neither did the authors.

DR. LIEBLER: I'm sure it's just particle sizing.

DR. SNYDER: So then for this use, does this have an aerosol use?

DR. LIEBLER: You know what? I'm sorry, just to -- fine versus ultra fine, on page 5, under Particle Size and Form, we've got amorphous silicas are composed of very fine particles, average 20 microns. Very fine, ultra fine, fine.

SPEAKER: Super fine.

DR. LIEBLER: Super fine.

SPEAKER: The point comes into question that we do have data here that says that the sum of the particles are respirable size, certainly the .01 to .1 micron diameter particles.

DR. LIEBLER: I don't know if there's a standard nomenclature of, you know, fine, ultra fine, very fine, that actually corresponds to giant particle diameter ranges. It might be something to look for and see because you list very fine in a way that just might mean it's sort of a kind of ordinary colloquia descriptor as opposed to whether or not very fine

means a particular size range. And if there is any definition in the literature that assigns the term "fine," "very fine," "ultra fine," the size range, this would be a good place to put it. This would be the ideal place to put it. So if there is any additional information you could find that would put it there, that would be useful there.

MS. BECKER: Okay.

DR. LIEBLER: I mean, I realize this whole area is a mess, but, you know.

MS. BECKER: Right. And it's a 1961 reference, so.

DR. LIEBLER: Yeah. I'm not sure where you could ask, but someone might be able to point you in the right direction. I forget who was here last time that made -- the Sassi people, I guess, you know, provided some input on -- some clarification on the nomenclature and forms. They may know something or be able to point you in the direction on sizing nomenclature. If there is any and if it's referred to in the types of particle study, it probably should be up front in this report.

MS. BECKER: Okay.

DR. KLAASSEN: On page 5, about the fifth or sixth line, it says there that very fine particles had an average of 20 micrometers.

DR. LIEBLER: Yeah, that's what I was pointing to. Yeah. Yeah. So I'm assuming fine is more than 20 micrometers and ultra fine is less.

MS. BECKER: Well, I think the phrase that might solve all of it, is right after the 20, is "which tends to aggregate loosely in the air." So something that size doesn't exist very long. It adheres onto others and makes larger particles.

DR. BELSITO: And I think that's what we were told before.

MS. BECKER: Yes.

DR. BELSITO: And then going on it says aggregates assemble in chains, fumed or clusters precipitated in gel. Agglomerates are assembled -- assemblies of aggregates held together by strong physical adhesion forces and not in a dispersible nano-size less than 100 nanometers.

MS. BECKER: I think that kind of solves it.

DR. BELSITO: So the concept of very fine is a laboratory concept, not a real concept in nature?

MS. BECKER: At least not in the air.

DR. BELSITO: At least not as it would be formulated into a cosmetic product. I seem to remember them telling us that, too. They rapidly sort of adhere together.

DR. LIEBLER: I was just looking for a way to address Paul's question about whether --

DR. SNYDER: I mean, it was deep in the document and all of a sudden this popped up. And I thought if we could pop in appropriate information to define that, that would be useful. If any of the subsequent literature refers to particle size and distinguishes effects on the basis of anything having to do with particle size, then I think we need to deal with it.

DR. BELSITO: But then we could put -- we could move that issue of the aggregation of these very fine particles into the discussion as well since there is a hairspray use. And I see that the panel noted data on the use of very fine, fine molecular structures, average of 20 microns.

SPEAKER: (off mike) they are in respirable range of diameter.

DR. BELSITO: Right. But it is our understanding that these aggregate into chains, fumed or clusters, precipitated in gel to particle sizes that would not be respirable in cosmetic formulations.

DR. KLAASSEN: In general, to get things down into the alveoli you want to have it between 1 and 10. Larger than 10 they don't get to the alveoli very well and if they're smaller than 1 they don't settle in the alveoli. They just blow them back out again. So, even at this 20 microns here they're relatively safe as far as getting them into the alveoli. You still have them in the bronchi, et cetera. So, what Don said I agree with. This just gives us even further protection.

DR. SNYDER: We have a statement on page 53 in the fourth paragraph, the last sentence, related to -- in relation to monkey status, it says the frequency and the size of the cell aggregates vary with the type of silica precipitated in greater (off mike) and greater than gel. So that's what we should capture there.

DR. HOWARD: It is in the discussion -- I mean, the summary. So you want that clearly in the discussion?

DR. SNYDER: Well, I mean, I think that's just some more data --

DR. BELSITO: Well, I think we did, particularly now that we've moved the aluminum iron silicates out of the conclusion. We're going to make mention about it in the discussion anyway. So then we could just expand upon it a little bit if the panel noted data on use of very fine silicas, average molecular size 20 microns. However, we noted that these tend to aggregate into -- help me.

DR. SNYDER: Tend to form aggregates.

DR. BELSITO: Tend to form aggregates of a size that would not be respirable.

DR. LIEBLER: But is the passage you're referring to, Paul, is that referring to the silica particles or cells aggregating? Because it says the frequency and size of the cells aggregates.

DR. BELSITO: Oh, oh.

DR. LIEBLER: That's why I'm reading.

DR. SNYDER: Oh, I see. Yeah.

DR. LIEBLER: I'm trying to see if there's anything that's being said about clumps or aggregates of, like, lymphocytes.

DR. SNYDER: No, I mean, to me (off mike) the other way. I read it that it was the aggregates as in aggregates of silica. I mean, I guess there's nothing in that paragraph to suggest otherwise, is there?

DR. LIEBLER: So I'm just wondering what that actually refers to. Because the preceding paragraph refers to considerable cellular infiltration of the alveoli and the alveolar septa.

DR. SNYDER: There's nothing about aggregation there.

DR. LIEBLER: And with the extension and accumulation of acetate and macrophages. See, that could easily be referring to clumps of macrophages, perhaps. That's how I would read that. So maybe check that language there.

DR. KLAASSEN: And if true, then this sentence should go up in the other paragraph.

DR. LIEBLER: Yeah.

DR. BELSITO: So where are you moving this, Curt?

DR. KLAASSEN: Well, into the previous paragraph. It really has to do with macrophage. If it really has to do with cells and the aggregation of cells, then it probably is more appropriate in the previous paragraph. But we, first of all, need to make sure what's going on here.

MS. BECKER: It's the study on page -- it starts at the very bottom of 35.

DR. SNYDER: Yeah. It's macrophage and (off mike) aggregate. So just change that to "Frequency and size of the inflammatory cell aggregates varied with the type of silica," and move it up to the previous paragraph, to the paragraph that begins, "Rabbits and (off mike)."

DR. BELSITO: But these weren't rabbits; these were monkeys.

DR. SNYDER: Oh, so the monkeys then.

DR. BELSITO: So that's the paragraph above it?

DR. SNYDER: Yes.

MS. BECKER: These are two different experiments. I'm sorry. Say what you want to change again.

DR. BELSITO: The paragraph above is a different study.

MS. BECKER: Right.

DR. BELSITO: These are two different studies in monkeys. So that paragraph has to -- I mean, you can't move it anywhere.

DR. SNYDER: Okay. All right.

DR. BELSITO: The monkeys were exposed to different types of silica. The precipitated silica had lower lung volumes. No change in parameters, ventilatory performance, mechanical parameters, dynamic lung compliance and FEP. When exposed to silica gel, the frequency and size of cellular aggregates varied with the type of silica.

DR. SNYDER: I would just change that sentence. So the frequency and size of inflammatory cell aggregates varied with the type of silica.

DR. BELSITO: Okay.

MS. BECKER: Okay.

DR. BELSITO: So the frequency and size of inflammatory cell aggregates varied with the type of silica. Okay.

DR. SNYDER: That'll do it.

DR. BELSITO: Okay. Industry comments from Sassi, page 53. It says: In our opinion the following statement on page 53 does not accurately describe the commercial pyrogenic process used to manufacture synthetic amorphous silica. Amorphous silica is the product of a high heat process applied to crystalline silica. The contemporary pyrogenic process is accurately described on page 6 of the report and should be substituted for the description on page 53.

I'm just reading what was sent out to us.

DR. SNYDER: I can't make it out.

MS. BECKER: Maybe 6 and 3?

DR. SNYDER: It's on page 50, actually.

MS. BECKER: Page 50.

DR. BELSITO: They may be referring to the old report. I don't know.

DR. SNYDER: Here it is on page 50, the second paragraph. (off mike) pyrogenic silica is a product of high heat process applied to crystalline and silica.

MS. BECKER: You're on 50?

DR. SNYDER: Page 50.

DR. BELSITO: Fifty, the first and second paragraph.

DR. SNYDER: Second paragraph, first line.

DR. BELSITO: So --

MS. BECKER: You want to get rid of that sentence?

DR. BELSITO: Well, no. They're saying that it's not the way it's produced. The way it's produced is --

DR. SNYDER: On page 6.

DR. BELSITO: What we said on page 6: Precipitated silica and silica gels are produced from an alkaline metal silicate dissolved in water and then acid, usually sulfuric.

DR. LIEBLER: No, they are actually probably referring to the bottom of page 5 on the current report, amorphous pyrogenic silica.

DR. BELSITO: Yes. Okay.

DR. LIEBLER: So here it says, on page 5, the bottom of our current report, it says, "Amorphous pyrogenic silica is manufactured by the hydrolysis of volatile silanes, usually silica and tetrachloride, in the flame of an oxygen hydrogen burner."

And then page 50, second paragraph of our second report, it says, "Amorphous pyrogenic silica is the product of a high heat process applied to crystalline silica."

MS. BECKER: Right. Which is of that.

DR. BELSITO: Right. So what they're saying is that's not -- the contemporary pyrogenic process is the process currently described on page 5.

MS. BECKER: Right. The rest of the paragraph, I think --

DR. LIEBLER: We agreed.

MS. BECKER: So we just want to get rid of the --

DR. BELSITO: You want the amorphous pyrogenic silica, you just want to --

DR. SNYDER: Capture from page 6.

DR. BELSITO: -- capture from page -- no, 5.

DR. LIEBLER: Yeah, right. So the sentence on page 50, the first sentence of the second paragraph, amorphous pyrogenic silica through -- applied to crystalline silica, delete that sentence and in its place copy the sentence from the bottom of page 5, "Amorphous pyrogenic silica through oxygen hydrogen burner." It's the same definition word for word from the bottom of page 5 instead.

MS. BECKER: Thank you.

DR. BELSITO: Okay. The next comment from Sassi is we noted in our earlier comments the lack of differentiation between silica fumes and the commercial product called fumed silica, i.e., pyrogenic silica, leads to a clear misunderstanding of the significance of the statement on page 8 -- may be different -- regarding the high level of crystalline silica impurity 6 to 8 percent noted in the Swensson 1971 study.

DR. SNYDER: On page 7, first sentence.

DR. BELSITO: Since silica fume is a commercial product not classified as synthetic amorphous silica, we recommend deleting this reference on the basis of irrelevance. So, that's now on page 7.

DR. SNYDER: First sentence, (off mike) composition of the fumes.

DR. KLAASSEN: So you want to eliminate the first paragraph? Is that what we're talking about?

DR. LIEBLER: Maybe the first sentence.

DR. BELSITO: The first sentence.

DR. LIEBLER: Swensson, et al., through courts.

DR. BELSITO: You have the Cabot Corporation. They're not saying anything about --

DR. LIEBLER: So that's two (off mike).

DR. BELSITO: So it would just be, "Cabot Corporation 2004 states that its silicate products are greater than 99.8 percent pure." The moisture content, yeah, treated silicas are susceptible to.

Okay. Next comment from Sassi. On page 3, two references to Spiron as a technical name for silica are noted. Our members are not aware of this technical name and suspect it is a trade name.

MS. BECKER: For silica?

DR. BELSITO: That may have already been removed because I'm not seeing Spiron here anywhere.

SPEAKER: I don't see it.

MS. BECKER: You have that little table somewhere (off mike)?

DR. BELSITO: No, it would have just -- it would have been on the page. I mean, maybe it was in the old report and it's already been deleted. Again, this letter seems to be addressing the old report and not --

MS. BECKER: Yeah, because they would have got the version that I produced right after the last panel meeting.

DR. BELSITO: Okay.

MS. BECKER: It's been edited since then one more time before you got it.

DR. BELSITO: Okay. What you may want to do, Lillian, again, just do a word search for "Spiron." Make sure that it's been deleted.

Okay. Page 24, a reference to a UNEP 2004 study mentioned the LC50 of 691 milligrams per liter. We believe the greater than symbol was omitted in error on the LC50, so.

SPEAKER: On page 21? Under inhalation, third paragraph?

DR. BELSITO: Okay. So you need to check and be certain that they're correct, that the LC50 was greater than 691.

MS. BECKER: Sure.

DR. BELSITO: Okay. In the discussion we noted that the last sentence to the paragraph was incomplete. It appears a word may have been omitted. I didn't notice a word omitted, so this may again --

DR. LIEBLER: Last sentence of which paragraph?

DR. BELSITO: It just says, "in the discussion section on page 50A." Well, it's not relevant anymore. We noted that the last sentence of the paragraph was incomplete.

MS. BECKER: Okay. Okay, it wasn't quite the last sentence. My guess is that the whole section was completely removed.

DR. BELSITO: Right. Okay. That was it from the silica council.

DR. SNYDER: They changed that sentence anyway. So instead of saying no pursuant silica is used -- to the panel determined that silicosis is not an issue since crystalline silica is not an ingredient used in cosmetics.

MS. BECKER: Okay.

DR. BELSITO: Okay.

DR. LIEBLER: I had a -- again, in the front on pages 4 and 5 of our current document, the use of subheads under, for example, Physical and Chemical Properties and then Properties.

MS. BECKER: I'm sorry. Where?

DR. LIEBLER: On page 4, Physical and Chemical Properties. And then you have Properties and then you have the subhead Silica. And then there's no other compound like silicates referred to.

I think when you don't have any other compound referred to, you can just delete the Silica subheading. I made a few notes like that, but then I stopped. I think it's a question if there's going to be silica and then you're going to do aluminum magnesium silicate, then you have the subheads for each. Otherwise, you just delete silica subheads.

MS. BECKER: Okay.

DR. BELSITO: Except that I find it helpful because then you know exactly what information you have under that particular heading. You can quickly, very visually see it rather than -- I know what you're saying.

DR. LIEBLER: Yeah.

DR. BELSITO: It's like you look at properties and the only properties we're going to get are on silica. It's not going to be on something else.

DR. LIEBLER: Okay. I'm an editorial slasher by nature, so.

DR. KLAASSEN: You can have silica property.

DR. BRESLAWEC: May I suggest that we do whatever the JAMA format requires us to do in terms of the IJT publication on that?

DR. BELSITO: Okay.

DR. BRESLAWEC: We'll follow the guidance there.

DR. BELSITO: Sure. Okay, good. That sounds reasonable. Anything else on this silica?

DR. LIEBLER: When judgment fails, fall back on policy.

SPEAKER: What?

DR. LIEBLER: When judgment fails, fall back on policy.

DR. BELSITO: Okay. So no other comments. We'll move to sodium and potassium bromate.

MS. BECKER: So we're going final?

DR. BELSITO: We're going final. And I think the change moving the aluminum iron out of the conclusion is really editorial. I mean, it's not substantive so I don't think we need to send it out again.

Marks' Team Meeting:

DR. MARKS: You're welcome. Next is silica and silicates. We have in front of us a "Tentative Report of Silica and Related Ingredients." There were comments from industry. There's a September 3 letter from SASSI, the Synthetic Amorphous Silica and Silicate Industry Association, who characterized their comments as being relatively minor. The conclusion is that these ingredients are safe as cosmetic ingredients, that aluminum iron silicate is safe as a cosmetic ingredient in the practices and uses described in the safety assessment when formulated to be nonrespirable, and I think there are some potential comments about that. Ron Shank?

DR. SHANK: I think the conclusion is okay. The SASSI suggestions I agree with to put in as they have requested. There is a UNEP report of 2004. On page 21 SASSI refers to the LC50, we say 0.691 and SASSI says it should be less than 0.691. That can be checked by going to the UNEP report. On page 45 under "Clinical Assessment of Safety," it says that the oral lethal dose is 15 grams per kilogram. That would be over 1 kilo per person, so that there is something wrong there, and it really doesn't add anything. I would just throw it out. It's an FDA comment or something. With due respect to FDA, I don't think that could possibly be correct that the oral lethal dose is 15 grams per kilo. It would be pretty hard to take a kilogram for an adult. Those are my only comments.

DR. MARKS: Lillian will capture those then. I'm not sure we need to mention that tomorrow unless you feel we need to.

DR. SLAGA: Right.

DR. MARKS: Are there any other comments? Ron Hill?

DR. BERGFELD: I'd like to make a comment that I thought it was nicely reorganized and redefined so that we were not as confused in reading it. Thank you.

DR. MARKS: I suspect tomorrow that our team will be seconding a motion that a final report be issued with the conclusions as stated on page 55, that these are safe and with the proviso that aluminum iron silicates are not respirable. Let's take a break for 5 minutes. You have more comments? After your comments, Jay.

DR. ANSELL: Just on the wording, this is the first report we hit where we put in this "were ingredients in this group not currently to be used in the future. The expectation is that they be used in product categories and concentrations comparable to others in the group," is a little tortured.

DR. MARKS: We've discussed that at some time in the past, Jay. Do you have a proposal to make it clear and less tortured?

DR. ANSELL: No, not right now.

DR. MARKS: When you come up with the proposed change, let us look at it. I know we all worked on it, and Alan particularly.

Full Panel Meeting:

DR. BERGFELD: We're moving on to "Silica," Dr. Belsito.

DR. BELSITO: Yes, at the last meeting we issued a tentative safety assessment that these ingredients -- silica, aluminum magnesium metasilicate, aluminum calcium sodium silicate, hydrated silica, sodium potassium aluminum silicate -- are safe as cosmetic ingredients in the practice of use in concentrations as described in the safety assessment, and put a caveat in that conclusion that aluminum ion silicate is safe as a cosmetic ingredient, the practice of use in concentration as described in the safety assessment when formulated to be non-respirable.

We thought that we would like to make a minor editorial change in that conclusion and just put aluminum ion silicate into the list of other silica products that are safe as used and move the discussion of the ability of these particles to be inhaled, which essentially they cannot be because of their size -- they tend to aggregate into large molecular sizes -- into the discussion rather than putting it into the conclusion.

DR. BERGFELD: And that's a motion.

DR. BELSITO: That's a motion.

DR. BERGFELD: Is there a second? Second, Paul? Discussion? Ron?

DR. SHANK: That's okay.

DR. BERGFELD: It's okay? Any other discussion?

DR. BELSITO: Yeah, in the discussion itself just putting -- stressing that these do tend to aggregate into larger molecular weight particles in formulation, stressing that a little bit more.

DR. BERGFELD: Any other discussion? Seeing none, I call the question. All those in favor of this conclusion please indicate by raising your hands. Unanimous. No abstainers. Okay.

Potassium Silicate, Sodium Metasilicate, and Sodium Silicate

December 20-21, 1999

Dr. Schroeter recalled that at the September 9-10, 1999 Panel meeting, these three silicate salts were removed from the CIR report on these ingredients and Silicate Minerals and Clays.

The Panel issued the following informal data request:

- (1) Physical and chemical properties, including octanol/water partition coefficient and impurities data
- (2) UV absorption (while these ingredients are not expected to have significant UV absorption, the Panel believes the report would be improved if these data were available rather than assumed)
- (3) Gross pathology and histopathology in skin and other major organ systems associated with repeated dermal exposures; and, if these data are suggestive, reproductive and developmental toxicity data may be needed
- (4) Dermal irritation and sensitization (what is the highest non-irritating dose?)
- (5) Mammalian genotoxicity data
- (6) Ocular irritation, if available; with the view of establishing the highest non-irritating dose

May 18-19, 2000

Dr. Schroeter noted that no response to the following informal data request issued at the December 20-21, 1999 Panel meeting was received:

- (1) Physical and chemical properties, including octanol/water partition coefficient and impurities data
- (2) UV absorption (while these ingredients are not expected to have significant UV absorption, the Panel believes the report would be improved if these data were available rather than assumed)
- (3) Gross pathology and histopathology in skin and other major organ systems associated with repeated dermal exposures; and, if these data are suggestive, reproductive and developmental toxicity data may be needed
- (4) Dermal irritation and sensitization (what is the highest non-irritating dose?)
- (5) Mammalian genotoxicity data
- (6) Ocular irritation, if available; with the view of establishing the highest non-irritating dose

He also stated that his Team determined that item 6 above is unnecessary and should be deleted from the list of data requests.

Dr. Schroeter also noted that the hypersensitivity test on Sodium Metasilicate that is being conducted by the National Toxicology Program study is nearing completion and that the preliminary data appear to be negative.

Concerning item 5 above, Dr. Belsito noted that the Panel has negative Ames test data on the silicate, but no test data on the metasilicate. Thus, the Belsito Team determined that Ames test data on the metasilicate and mammalian genotoxicity data on the silicate and metasilicate are needed.

Dr. Slaga recalled that Ames mutagenicity test data on Sodium Silicate are included in the CIR report.

Dr. McEwen did not see the need for another non-mammalian mutagenicity assay, considering that assays of this type are included in the report.

Dr. Klaassen noted that bacterial mutagenicity data on Sodium Metasilicate are not included in the CIR report and need to be requested.

Dr. McEwen said that based on the negative Ames test data on Sodium Silicate, it is expected that the other two ingredients also are not mutagenic. He did not see the need for additional mutagenicity tests on either of the three ingredients.

Dr. Belsito noted that his Team did not mention specific ingredients in any of the other data requests and asked whether this should be done because of differences in chemical structure.

Dr. Slaga noted that the three chemicals in this review are very similar and it is possible that data on one chemical may be used to evaluate the safety of another.

The Panel voted unanimously in favor of issuing an insufficient data announcement with the following data requests:

- (1) Physical and chemical properties, including the octanol/water partition coefficient and impurities data
- (2) Gross pathology and histopathology in skin and other major organ systems associated with repeated dermal exposures; and if these data are suggestive, reproductive and developmental toxicity data may be needed
- (3) Human dermal irritation and sensitization (specifically, the Panel wants to know the highest non-irritating dose)
- (4) Two genotoxicity studies for Sodium Metasilicate, one of which should be in a mammalian system; and one mammalian genotoxicity study for either Potassium or Sodium Silicate
- (5) Ocular irritation data, if available (again with the view of establishing a non-irritating dose)

December 4-5, 2000

At the May 18-19, 2000 Panel meeting, the Panel voted unanimously in favor of issuing an insufficient data announcement with the following data requests:

- (1) Physical and chemical properties, including the octanol/water partition coefficient and impurities data
- (2) Gross pathology and histopathology in skin and other major organ systems associated with repeated dermal exposures; and if these data are suggestive, reproductive and developmental toxicity data may be needed
- (3) Human dermal irritation and sensitization (specifically, the Panel wants to know the highest non-irritating dose)
- (4) Two genotoxicity studies for Sodium Metasilicate, one of which should be in a mammalian system, and one mammalian genotoxicity study for either Potassium or Sodium Silicate
- (5) Ocular irritation data, if available (again, with the view of establishing a non-irritating dose)

Dr. Schroeter stated that unpublished data from industry were received in response to the preceding announcement and that the Panel also received additional published studies. He then noted that his Team concluded that the available data on Potassium Silicate, Sodium Metasilicate, and Sodium Silicate are no longer insufficient for the following reasons, addressing each item on the list of data requests:

- (1) Data on chemical and physical properties (Item 1) are available and further information is not needed. The octanol/water partition coefficient (Item 1) is not needed because these ingredients are probably poorly absorbed through the skin.
- (2) Item 2 above is not needed because there was no evidence of developmental toxicity and these ingredients are probably poorly absorbed through the skin.
- (3) Item 3 is not needed. Irritancy may be a problem, but appropriate formulations should decrease the likelihood of skin irritation.
- (4) Item 4 is not needed. On the basis of limited skin absorption, mutagenicity and genotoxicity data are not necessary.
- (5) Item 5 is not needed. Ocular irritation may be avoided by formulation in rinse-off products to create a non-irritating product. Leave-on product cautionary statements may also be developed.

Dr. Schroeter said that, based on the preceding comments, the reasons why the data originally requested are no longer needed should be stated in the report discussion.

Dr. Belsito noted that Sodium Silicate is used in skin cleansing products, which include cleansing lotions, liquids, and pads (which may be considered rinse-off products) and cold creams (which may be considered leave-on products). He also noted that Sodium Silicate is used in skin cleansing products at concentrations up to 10.0%, and that any leave-on product containing 10.0% Sodium Silicate may be irritating to the skin. Dr. Belsito added that a safe as used conclusion for ingredient use at this concentration in a cold cream would probably be inappropriate, given the uncertainty as to whether or not the skin cleansing cold creams are classified as leave-on products.

The possibility of concentration limits for Sodium Silicate (up to 4.0%, based on available data) as well as Sodium Metasilicate in leave-on products was also mentioned, taking into consideration that Sodium Metasilicate has a different type of irritation potential when compared to Sodium Silicate. Dr. Belsito said that a concentration limit for Sodium Metasilicate needs to be determined.

Dr. Shank noted that Sodium Metasilicate is used only in rinse-off products.

Dr. Schroeter said that the irritation potential of Sodium Silicate should be addressed by indicating in the report discussion that products containing this ingredient should be formulated to avoid skin irritation. He did not feel that a concentration limit should be established for this ingredient.

Dr. Belsito agreed that Potassium Silicate, Sodium Metasilicate, and Sodium Silicate are safe as used in cosmetic products when formulated to avoid skin irritation, and proposed this statement for the report conclusion. The Panel voted unanimously in favor of issuing a Tentative Report with the following conclusion: Based on the animal and clinical data included in this report, the CIR Expert Panel concludes that Potassium Silicate, Sodium Metasilicate, and Sodium Silicate are safe as used in cosmetic products when formulated to avoid skin irritation.

June 4-5, 2001

Dr. Schroeter recalled that a Tentative Report with the following conclusion was issued at the December 4-5, 2000 Panel meeting: The CIR Expert Panel concludes that Potassium Silicate, Sodium Metasilicate, and Sodium Silicate are safe as used in cosmetic products when formulated to avoid skin irritation.

Dr. Schroeter also noted that unpublished data (clinical skin irritation studies on Sodium Silicate and Sodium Metasilicate) considered by the Panel at its December 2000 meeting have been incorporated into the report text, and that these data do not warrant any change in the Panel's tentative conclusion.

The Panel voted unanimously in favor of issuing a Final Report with the following conclusion: Based on the available data contained within this report, the CIR Expert Panel concluded that Potassium Silicate, Sodium Metasilicate, and Sodium Silicate are safe when formulated to avoid irritation in cosmetic formulations.

Aluminum Silicate, Calcium Silicate, Magnesium Aluminum Silicate, Magnesium Silicate, Magnesium Trisilicate, Potassium Silicate, Sodium Magnesium Silicate, Sodium Metasilicate, Sodium Silicate, Zirconium Silicate, Attapulgit, Bentonite, Fuller's Earth, Hectorite, Kaolin, Lithium Magnesium Silicate, Lithium Magnesium Sodium Silicate, Montmorillonite, Pyrophyllite, and Zeolite

September 9-10, 1999

Dr. Belsito noted that this group of ingredients consists mostly of clay-like materials, but that salts (i.e., Potassium Silicate, Sodium Metasilicate, Sodium Silicate, and, possibly, Zirconium Silicate) are also included. He also recalled studies indicating that the salts, but not the clays, were irritants, and that his Team recommended that these four salts should be included in a separate report. The Belsito Team also concluded that the remaining ingredients are safe as used in cosmetic products. Dr. Belsito said that his Team will make a decision on specific data requests after the current report has been divided into two separate reports.

Dr. Schroeter said that his Team agreed that the ingredients in this review could be separated into two groups, soluble salts, which may be active (Sodium Metasilicate, Potassium Silicate, and Sodium Silicate) and minerals of solids (or clays) within the same report. He noted that the clays have no absorption and are basically safe, except for the possibility of irritation. Dr. Schroeter also noted that cosmetic use includes sprays and that the issue of inhalation exposure could be addressed in the report discussion as a cautionary item. Furthermore, he said that the irritation potential of clays could be addressed in the report discussion by stating that concentrations in formulation that induce irritation should be avoided.

Dr. Andersen said that according to yesterday's Team discussions, the principal issue concerning the soluble salts relates to irritation. Therefore, he said that if the conclusion on this group of ingredients could reflect the need to formulate so that products are not irritating, then that concern could be eliminated.

Dr. Andersen also said that it may be possible for the Panel to issue a tentative conclusion on this group of ingredients. He recalled that, except for the issue of inhalation exposure to clays, there are no other safety issues and, thus, the clays could be considered safe as used.

Dr. Belsito agreed that a safe as used conclusion could be issued on the clays. He also said that it could be stated in the report discussion that data on the use of clays in aerosolized products are insufficient.

Dr. Shank expressed concern over the possibility of silicosis following inhalation exposure to dust particles.

Dr. McEwen said that silicosis is not a concern because these ingredients are not composed of crystalline silicone. However, he noted that pneumoconiosis may be a concern.

Dr. Andersen noted that crystalline forms do exist.

Dr. Belsito proposed dividing the current document into two reports. One of the reports will contain a safe as used conclusion on the clays and the other report on the salts will be re-reviewed as a separate document. Dr. Belsito speculated that the issue of irritation will be the only safety issue relating to the salts.

The Panel agreed with Dr. Belsito's proposal.

Dr. Schroeter confirmed that the issue of inhalation relating to the clays will be addressed in the report discussion.

The Panel voted unanimously in favor of issuing a Tentative Report with a safe as used conclusion (and appropriate report discussion) on the clays.

The Panel also voted unanimously in favor of incorporating the data on the soluble salts from the current report into a separate document that will be reviewed by the Panel.

Dr. Bergfeld stated that the report on the soluble salts will be reviewed at the next Team meeting.

February 14-15, 2000

Dr. Schroeter stated that a Tentative Report with a safe as used conclusion was issued at the September 9-10, 1999 Panel meeting. He then noted that one of the ingredients included in this review, Magnesium Silicate, had been considered talc, and that FDA informed the Panel that there is a considerable amount of data indicating that talc may have carcinogenic potential and that this issue is being addressed. Dr. Schroeter pointed out that the structure and CAS number of Magnesium Silicate are different from those associated with talc, and that this should be clarified in the CIR report.

Dr. Belsito said that the fact that talc is not one of the ingredients in this review should be stated in the report introduction and discussion, and also noted that talc will be the subject of another review by the CIR Expert Panel. The Panel voted unanimously in favor of issuing a Final Report with a safe as used conclusion on the Aluminum Silicate ingredient family.

Because of the number of ingredients to date for which the issue of particle size (relating to inhalation or aerosol exposure) has been raised, Dr. Bergfeld asked Dr. Belsito to review the caveat relating to particle size that has been included in CIR reports. Dr. Bergfeld informed the Panel that this caveat will be discussed at the upcoming Panel meeting.

Dr. Bergfeld also noted that because it is likely that the Panel will review talc at some point, the Panel's prioritization of this ingredient for review should be considered.

Dr. Belsito added that it is his understanding that FDA has reviewed talc and has not found that the data warrant any immediate action. He said that talc should be added to the CIR Priority List, but should not necessarily be added at the top of the list.

Dr. Bailey said that there are some aspects of talc that would be of interest, more so from the perspective of setting standards or specifications for talc in terms of particle size. He noted that the results of an NTP inhalation study (animals) on talc indicated exposure-related carcinogenic effects that were attributed to particle size. In this study, the particle size of the talc was smaller than that used in cosmetics. Dr. Bailey added that he has not reviewed any comprehensive data that address the particle size of talc that is used in cosmetics (i.e., the particle size distribution). In light of the NTP finding, he also said that in order for one to have a higher level of confidence relative to inhalation exposure, data on particle size distribution (in cosmetics) would be very useful.

Dr. McEwen said that the NTP study results were not linked directly to the talc, but to the overload and a secondary mechanism. He also said that the effects of talc in miners and millers of this chemical have been studied over a period of 50 to 60 years. The magnitude of the lung effects seen in a specific talcosis is basically pneumoconiosis, which can be identified by the crystalline structure in X-rays. Dr. McEwen added that lung cancer has never resulted from exposure to talc itself. However, talc that is mined from asbestiform-containing mineral deposits has been implicated in cancer, specifically, the asbestiform particulate. According to Dr. McEwen, the specification for cosmetic grade talc indicates that it contains no asbestiform particulate.

Dr. Bailey wanted to know the extent of industry compliance with the CTFA specification for cosmetic grade talc. He said that it would be nice to have some assurance that the standard is being implemented.

Dr. McEwen said that relevant sampling would have to be done in order to insure this.

Dr. Bailey said that the Expert Panel could request these data, and that the Panel's efforts may be more successful than those of FDA.

Dr. Bailey also said that another issue relates to perineal use of talc and ovarian cancer, and that, based on the available data, FDA has not arrived at any conclusion relative to this issue.

Dr. Bergfeld said that information relating to particle size will be retrieved from CIR reports for review. She noted that the Panel has been faced with issues relating to aerosol exposure to cosmetic ingredients, and that previous statements regarding particle size need to be captured for future use in safety assessments.

Amended Safety Assessment of Silicates as Used in Cosmetics

Status: Draft Tentative Amended Report for Panel Review
Release Date: February 16, 2021
Panel Meeting Date: March 11-12, 2021

The Expert Panel for Cosmetic Ingredient Safety members are: Chair, Wilma F. Bergfeld, M.D., F.A.C.P.; Donald V. Belsito, M.D.; David E. Cohen, M.D.; Curtis D. Klaassen, Ph.D.; Daniel C. Liebler, Ph.D.; Lisa A. Peterson, Ph.D.; Ronald C. Shank, Ph.D.; Thomas J. Slaga, Ph.D.; and Paul W. Snyder, D.V.M., Ph.D. Previous Panel member involved in this assessment: James G. Marks, Jr., M.D. The Cosmetic Ingredient Review (CIR) Executive Director is Bart Heldreth, Ph.D. This safety assessment was prepared by Christina L. Burnett, Senior Scientific Analyst/Writer, CIR.

DRAFT ABSTRACT

The Expert Panel for Cosmetic Ingredient Safety (Panel) assessed the safety of 24 silicate ingredients. These ingredients are solid inorganic oxides, comprising in part, silicon dioxide, that can be derived from naturally occurring minerals or can be produced synthetically. These ingredients are reported to function as abrasives, absorbents, bulking agents, and/or deodorant agents in cosmetic products. The Panel reviewed relevant data, including frequency and concentration of uses. The Panel concluded that... (to be determined).

INTRODUCTION

The Expert Panel for Cosmetic Ingredient Safety (Panel) previously reviewed the safety of Aluminum Silicate, Calcium Silicate, Magnesium Silicate, Magnesium Trisilicate, Sodium Magnesium Silicate, Zirconium Silicate, Lithium Magnesium Silicate, and Lithium Magnesium Sodium Silicate in a report that was published in 2003.¹ The Panel concluded that these ingredients are safe as used in cosmetic products. In accordance with its Procedures, the Panel evaluates the conclusions of previously-issued reports every 15 years, and it has been at least 15 years since this assessment has been issued. This report has been reopened to include additional ingredients, several of which were also previously reviewed in other safety assessments. Potassium Silicate, Sodium Metasilicate, and Sodium Silicate (report published in 2005) were found to be safe for use in cosmetic products in the practices of use and concentration described in the safety assessment when formulated to avoid irritation,² and Aluminum Iron Silicates, Magnesium Aluminometasilicate (previously known as Alumina Magnesium Metasilicate), and Sodium Potassium Aluminum Silicate (report finalized in 2009) were determined to be safe as cosmetic ingredients in the practices of use and concentrations as described in the safety assessment.³

In total, this report assesses the safety of 24 ingredients (listed below; previously reviewed ingredients are in red) as used in cosmetics. According to the web-based *International Cosmetic Ingredient Dictionary and Handbook* (wINCI; *Dictionary*; see Table 1), the majority of these ingredients are reported to function as abrasives, absorbents, bulking agents, and/or deodorant agents in cosmetic products.⁴

Aluminum Calcium Sodium Silicate

Aluminum Iron Calcium Magnesium Germanium Silicates

Aluminum Iron Calcium Magnesium Zirconium Silicates

Aluminum Iron Silicates**Aluminum Silicate**

Ammonium Silver Zinc Aluminum Silicate

Calcium Magnesium Silicate

Calcium Silicate**Lithium Magnesium Silicate****Lithium Magnesium Sodium Silicate****Magnesium Aluminometasilicate****Magnesium Aluminum Silicate****Magnesium Silicate****Magnesium Trisilicate****Potassium Silicate****Pyrophyllite**

Sodium Magnesium Aluminum Silicate

Sodium Magnesium Silicate**Sodium Metasilicate****Sodium Potassium Aluminum Silicate****Sodium Silicate**

Sodium Silver Aluminum Silicate

Zinc Silicate

Zirconium Silicate

The Panel has also reviewed other related ingredients. In a report that was finalized in 2019, the Panel concluded that synthetically-manufactured amorphous silica and hydrated silica are safe in the present practices of use and concentration when formulated to be non-irritating.⁵ In 2013, the Panel published a report with the conclusion that silylates and surface-modified siloxysilicates (i.e., silica silylate, silica dimethyl silylate, trimethylsiloxysilicate, and trifluoropropyldimethyl/trimethylsiloxysilicate) are safe as used in cosmetics when formulated and delivered in the final product not to be irritating or sensitizing to the respiratory tract.⁶ The ingredients included in these reports are not part of this amended safety assessment.

This safety assessment includes relevant published and unpublished data that are available for each endpoint that is evaluated. Published data are identified by conducting an exhaustive search of the world's literature. A listing of the search engines and websites that are used and the sources that are typically explored, as well as the endpoints that the Panel typically evaluates, is provided on the Cosmetic Ingredient Review (CIR) website (<https://www.cir-safety.org/supplementaldoc/preliminary-search-engines-and-websites>; <https://www.cir-safety.org/supplementaldoc/cir-report-format-outline>). Unpublished data are provided by the cosmetics industry, as well as by other interested parties.

Some chemical and toxicological data on the silicate ingredients included in this safety assessment were obtained from robust summaries of data submitted to the European Chemical Agency (ECHA) by companies as part of the REACH chemical registration process.⁷⁻¹³ Additionally, some data were obtained from assessments by the Organisation for Economic Co-Operation and Development Screening Information Data Sets (OECD SIDS).¹⁴ These data summaries are available on the ECHA and OECD SIDS websites, respectively, and when deemed appropriate, information from the summaries has been included in this report.

Excerpts from the summaries of the 2003 and 2005 reports on silicates are disseminated throughout the text of this review document, as appropriate, and are identified by *italicized text*. (This information, except for chemical and physical properties, is not included in the tables or the summary section.) Select summary information from the 2019 silica report is also included. Data on the silicate ingredients from the report finalized in 2009 has been incorporated into this safety assessment due to reorganization. The original reports that were published or finalized in 2003, 2005, and 2009, and the reports on related ingredients, are available on the CIR website (<https://www.cir-safety.org/ingredients>).

CHEMISTRY

Definition

These silicate ingredients that are inorganic oxides, comprising in part, silicon dioxide, are solids that can be derived from naturally occurring minerals. However, the ingredients in this safety assessment can be produced synthetically. The Panel considered the method of manufacture of these ingredients (whether synthetic or mined) to be of significant importance to safety, as synthetically derived ingredients are expected to have controlled crystalline material formation. The definitions and functions of the silicate ingredients included in this safety assessment are provided in Table 1.

Chemical Properties

Chemical properties of silicate ingredients are provided in Table 2. These ingredients are inorganic salts of silica; as such, these ingredients are solids and can be either crystalline or amorphous. Most of these ingredients, generally, are not soluble in water, but a few, like Calcium Silicate and Sodium Metasilicate, have limited or full water solubility.^{7,8,10,11,13}

Method of Manufacturing

While some of these ingredients are naturally occurring minerals, it is possible to manufacture these ingredients via partially synthetic means from other minerals, or via *de novo* synthesis. Aluminum Silicate is a naturally occurring mineral as well as artificially produced.¹ Synthetic Aluminum Silicate is formed by heating compositions of controlled proportions of silica, alumina, and alkalis under conditions to promote the specific structure. Sodium Silicate and Sodium Metasilicate are either made by high temperature fusion of silica and soda or by a hydrothermal process using silica and sodium hydroxide as starting materials.² Potassium Silicate can be also be produced by high temperature fusion of potassium carbonate and sand.

Method of manufacturing for Calcium Silicate, Magnesium Silicate, Magnesium Aluminum Silicate, Potassium Silicate, Sodium Magnesium Silicate, Sodium Metasilicate, Sodium Silicate, and Sodium Silver Aluminum, including particle size (prior to consumer product formulation) information where available, is provided in Table 3. These ingredients are produced from synthesized and mined materials.¹⁵⁻¹⁹

Composition/Impurities

Crystallinity and purity for Calcium Silicate, Magnesium Silicate, Potassium Silicate, Sodium Metasilicate, and Sodium Silicate is provided in Table 3.¹⁵ Crystallinity is reported to be < 0.2% for Calcium Silicate and Magnesium Silicate and < 0.1% for Potassium Silicate, Sodium Metasilicate, and Sodium Silicate.

Aluminum Calcium Sodium Silicate

A supplier reported that the Aluminum Calcium Sodium Silicate used in their trade name mixtures is amorphous and does not contain crystalline silica.²⁰ Another supplier reported that an X-ray powder diffraction analysis of an Aluminum Calcium Sodium Silicate product found it contained no crystalline silica and is amorphous Aluminum Silicate (no peaks were identified at 22° or 21/27°, which are the specific peaks for cristobalite and quartz, respectively).²¹ The composition was 53.6% silicon dioxide, 29.45 aluminum oxide, 8.3% sodium oxide, and 8.3% calcium oxide.

Aluminum Silicate

Other minerals associated with natural Aluminum Silicates are anauxite, dickite, kaolinite, kochite, mullite, newtonite, pyrophyllite, takizolite, and terierite.¹

Calcium Silicate

According to the *Food Chemicals Codex*, Calcium Silicate may not contain more than 10 mg/kg fluoride and not more than 5 mg/kg lead.¹⁶ The Joint Food and Agriculture Organization of the United Nations (FAO)/World Health Organization (WHO) Expert Committee on Food Additives (JECFA) specified that Calcium Silicate contains not more than 50 mg/kg fluoride, not more than 5 mg/kg lead, and not more than 3 mg/kg arsenic.²²

Magnesium Aluminum Silicate

A group of Magnesium Aluminum Silicate trade name mixtures contained 1% to 6% by volume weight crystalline Silica in the form of cristobalite.¹ The product may also contain quartz.

A supplier reported that their product consists of 100% Magnesium Aluminum Silicate.¹⁷ In the testing of 4 lots of product, the presence of crystalline silica was non-detectable (limit of detection = 0.1%).

Magnesium Silicate

According to the *Food Chemicals Codex*, Magnesium Silicate may not contain more than 10 mg/kg fluoride and not more than 5 mg/kg lead.¹⁶ JECFA specified that Magnesium Silicate contains not more than 1% free alkali (as sodium hydroxide), not more than 3% soluble salts, not more than 10 mg/kg fluoride, and not more than 5 mg/kg lead.²³

Sodium Magnesium Aluminum Silicate

According to the *Food Chemicals Codex*, Sodium Magnesium Aluminum Silicate (listed as sodium magnesium aluminosilicate) may not contain more than 5 mg/kg lead.¹⁶

Sodium Magnesium Silicate

A supplier reported that their synthetic product is 100% pure Sodium Magnesium Silicate, with no crystalline silica.¹⁸ The chemical composition is 59.0% silicon dioxide, 28.0% magnesium oxide, and 4.0% sodium oxide.

Sodium Metasilicate

*The arsenic and lead maximum limits in Sodium Metasilicate are 3 ppm and 20 ppm, respectively.*²

According to the *Food Chemicals Codex*, Sodium Metasilicate may not contain more than 5 mg/kg lead.¹⁶

Sodium Silicate

*The arsenic and lead maximum limits in Sodium Silicate (40% solution) are 3 ppm and 20 ppm, respectively.*²

Sodium Silver Aluminum Silicate

A supplier reported that in the production of Sodium Silver Aluminum Silicate, raw materials and the final product do not contain crystalline silica as an impurity.²⁴

USE

Cosmetic

The safety of the cosmetic ingredients included in this assessment is evaluated based on data received from the US Food and Drug Administration (FDA) and the cosmetics industry on the expected use of these ingredients in cosmetics. Use frequencies of individual ingredients in cosmetics are collected from manufacturers and reported by cosmetic product category in the FDA Voluntary Cosmetic Registration Program (VCRP) database. Use concentration data are submitted by the cosmetics industry in response to surveys, conducted by the Personal Care Products Council (Council), of maximum reported use concentrations by product category.

According to 2021 VCRP data, Magnesium Aluminum Silicate has the most reported uses in cosmetic products, with a total of 383; the majority of the uses are in leave-on eye makeup preparations and skin care preparations (Table 4).²⁵ Aluminum Calcium Sodium Silicate has the second most reported uses in cosmetic products, with a total of 103; the majority of the uses are in lipsticks. (The reported numbers of uses for the remaining ingredients in this report are much lower.) The frequencies of use for both of these ingredients have greatly changed since the original safety assessments were finalized; in 1998, Magnesium Aluminum Silicate was reported to have 632 uses, and in 2009, Aluminum Calcium Sodium Silicate was reported to have 7 uses.¹⁻³ The results of the concentration of use survey conducted in 2018 by the Council indicate Aluminum Calcium Sodium Silicate has the highest reported maximum concentration of use for leave-on products; it is used at up to 26.3% in eye shadows.²⁶ Magnesium Silicate is reported to have a maximum concentration of use for leave-on products of 21.6% in eye shadows.²⁷ According to the original safety assessment, the maximum use concentration in 2008 for Aluminum Calcium Sodium Silicate was 6% in foundations and lipsticks.³ Additionally according to 1999 data, there were no reported uses for Magnesium Silicate.¹ Leave-on concentrations of use reported in the previous review of these silicate ingredients were lower than the current leave-on maximum concentration of use. The 10 silicate ingredients with no reported uses in the VCRP database or in the Council's concentration of use survey are listed in Table 5.

Many of the silicate ingredients described in this safety assessment may be used in products that can be incidentally ingested or come into contact with mucous membranes; for example, Magnesium Silicate is used in lipstick at 10% and Aluminum Calcium Sodium Silicate is used in lipstick at up to 5.5%.^{26,27} Additionally, the silicate ingredients have been reported to be used in products that may come into contact with the eyes, such as eye shadows, eye liners, and mascaras. Magnesium Silicate at up to 26.3% in eye shadows.²⁷

Moreover, these ingredients are reported to be used in spray products that could possibly be inhaled; for example, Calcium Silicate is used at up to 0.005% in hair color sprays and Lithium Magnesium Silicate is used at up to 0.4% in face and neck sprays. Concerning final consumer product formulations (typically a mixture of ingredients), the Panel has noted that in practice, 95% to 99% of the droplets/particles released from cosmetic sprays have aerodynamic equivalent diameters > 10 µm, with propellant sprays yielding a greater fraction of droplets/particles below 10 µm compared with pump spray.²⁸⁻³¹ Therefore, most droplets/particles incidentally inhaled from cosmetic sprays would be deposited in the nasopharyngeal and bronchial regions and would not be respirable (i.e., they would not enter the lungs) to any appreciable amount.^{28,30} Ingredients in this report are also used in powders, and these products could possibly be inhaled. For example, Calcium Silicate and Magnesium

Aluminum Silicate are reported to be used at up to 5% and 1% in face powders, respectively.²⁷ Conservative estimates of inhalation exposures to respirable particles during the use of loose powder cosmetic products are 400-fold to 1000-fold less than protective regulatory and guidance limits for inert airborne respirable particles in the workplace.³²⁻³⁴

According to 21 CFR §73.2400, Pyrophyllite is an approved color additive for cosmetics in the US when applied externally in amounts consistent with good manufacturing practice.

In regulations on cosmetic products in the European Union, zirconium and its compounds (including Zirconium Silicate) are listed under Annex II-substances prohibited in cosmetic products.³⁵ Annex IV (colorants allowed in cosmetic products) lists natural hydrated Aluminum Silicate (containing calcium, magnesium or iron carbonates, ferric hydroxide, quartz-sand, mica, etc. as impurities). When used as a color in Europe, this ingredient must be labeled as CI 77004). The remaining silicate-related ingredients listed in this report are not restricted from use in any way under the rules governing cosmetic products in the European Union.

Non-Cosmetic

Aluminum Silicate is approved as an indirect food additive, according to the Code of Federal Regulations (CFR).¹ Pyrophyllite is listed as a naturally occurring color additive in the CFR. Calcium Silicate, Magnesium Aluminum Silicate, and Magnesium Trisilicate are used in over-the-counter drug products.

Potassium Silicate and Sodium Silicate were reported as being used in industrial cleaners and detergents.² Sodium Metasilicate is a generally recognized as safe (GRAS) food ingredient.

According to the Australian Industrial Chemicals Introduction Scheme (AICIS) the following ingredients are Tier I chemicals (not considered to pose an unreasonable risk to the health of workers and public health): Aluminum Silicate, Calcium Silicate, Magnesium Silicate, Magnesium Trisilicate, and Sodium Potassium Aluminum Silicate.³⁶ Potassium Silicate, Sodium Silicate, and Sodium Metasilicate are Tier II chemicals (require risk management measures to be instituted for safe use for human health or the environment). The remaining silicates have no AICIS determination.

Aluminum Calcium Sodium Silicate

Aluminum Calcium Sodium Silicate (hydrated) is used for countering the effects of aflatoxin in animal feed.³⁷⁻⁴⁸ This ingredient is also GRAS in the US in food for use as an anticaking agent at a level not exceeding 2% in accordance with good manufacturing practices (21 CFR §182.2729).

Calcium Silicate

Calcium Silicate is used in endodontics in root canal sealer preparations and dental cements.⁴⁹⁻⁵¹

Pyrophyllite

According to 21 CFR §73.1400, Pyrophyllite is an approved color additive for drugs in the US when applied externally in amounts consistent with good manufacturing practice. As described in the regulation, this ingredient is a naturally occurring mineral substance consisting predominantly of a hydrous aluminum silicate intimately mixed with lesser amounts of finely divided silica. Small amounts (< 3%) of other silicates, like potassium aluminum silicate, may be present. Specifications indicate that Pyrophyllite should not have more than 20 ppm lead and not more than 3 ppm arsenic

Sodium Magnesium Aluminum Silicate

Sodium Magnesium Aluminum Silicate is reported to be used in print enhancement (imparting high brightness and opacity), paper filer, and carbonless copy intensifier.⁵²

Zinc Silicate

Zinc Silicate is reported to be used as phosphors (in television screens), in spray ingredients (spray type not stated), and to remove traces of copper from gasoline.^{52,53}

TOXICOKINETICS

Absorption, Distribution, Metabolism, Excretion (ADME)

In a study of dogs to determine the bioavailability of silicon and aluminum from several mineral compounds, no statistically significant absorption of aluminum was recorded in assayed plasma samples of dogs given Magnesium Trisilicate orally.¹ This study did note elevated levels of silicon. The urinary silica excretion following orally dosing five human males with 20 g of Magnesium Trisilicate was 5.2%.

Sodium Silicate administered orally in rats acts as a mild alkali and was readily absorbed from the alimentary canal and excreted in the urine.² Urinary silicon excretion following orally dosing rats with Sodium Silicate at 40 and 1000 mg/kg was 18.9% and 2.8%, respectively.

Animal**Oral****Sodium Metasilicate**

In a dietary ADME study, 5 guinea pigs received silica (0.8 mg/g feed) as three separate forms (Sodium Metasilicate, hydrated silica, and silica solution (30%)) in single doses or in four repeated doses every 48 h.^{54,55} Urine and feces were collected in 48-h increments after each dose of each form and analyzed for silica content. For the Sodium Metasilicate doses, the urinary output of silica peaked within 48 h and gradually returned to normal after 8 d. When administered four times, 48 h apart, the peak was maintained, but did not increase. Within 48 h after the last dose, the concentration of silica in the urine began to return to normal. With the silica solution and hydrated silica, the urinary output of silica also peaked within 48 h and gradually returned to normal after 8 d, but the peaks were much lower than those observed with Sodium Metasilicate. When administered four times, 48 h apart, the silica concentrations behaved similarly to the Sodium Metasilicate form, except with a lower peak. In this study, approximately 63% of the silica was recovered. The authors of the study suggested that the silica in the urine was in the soluble or molybdate reactive form, and that the silica particles underwent depolymerization prior to excretion.

TOXICOLOGICAL STUDIES**Acute Toxicity Studies****Synthetically-Manufactured Amorphous Silica and Hydrated Silica****Inhalation**

In acute inhalation studies that ranged in duration from 1 to 6 h, the LC_{50s} for Hydrated Silica (30% SiO₂) and Silica (concentration not reported) in rats were > 3300 mg/m³ and > 191,300 mg/m³, respectively.

Silicates

The acute dermal LD₅₀ was > 3500 g/kg for rabbits exposed to Magnesium Aluminum Silicate.¹ The following are acute oral LD₅₀ determinations: Calcium Silicate, 3400 mg/kg in rats; Magnesium Aluminum Silicate, 50,000 mg/kg in mice; and Zirconium Silicate, > 200,000 mg/kg in mice

The toxicity of Potassium Silicate, Sodium Metasilicate, and Sodium Silicate has been related to the molar ratio of SiO₂/Na₂O and the concentration.² The acute oral LD₅₀ of Sodium Metasilicate ranged from 847 mg/kg in male rats to 1349.3 mg/kg in female rats, and from 770 mg/kg in female mice to 820 mg/kg in male mice. Gross lesions of variable severity were found in the oral cavity, pharynx, esophagus, stomach, larynx, lungs, and kidneys of dogs receiving 250 mg/kg or more of a commercial detergent containing Sodium Metasilicate. Similar lesions were seen in pigs given the same detergent and dose as in the previous study. Male Sprague-Dawley rats orally administered 464 mg/kg of a 20% solution containing either 2.0 or 2.4 ratio of Sodium Silicate to 1.0 ratio of sodium oxide showed no signs of toxicity, whereas doses of 1000 and 2150 mg/kg produced gasping, dyspnea, and acute depression. Acute intraperitoneal injections of a neutralized 2% solution of Sodium Metasilicate in white rats resulted in a decrease in spleen weight and relative enlargement of the kidneys.

Acute dermal, oral, and inhalation data are summarized in Table 6. Potassium Silicate (30% solution in water) had a dermal LD₅₀ > 5000 mg/kg in rats.⁹ In oral rat studies, the LD_{50s} were > 2000 mg/kg for Aluminum Silicate (concentration not reported), Sodium Magnesium Aluminum Silicate (concentration not reported), and Sodium Silicate.^{8,11,12} Calcium Silicate (20%) and Potassium Silicate (concentration not reported) had LD_{50s} of > 10,000 mg/kg and > 5000 mg/kg in rats, respectively.^{9,13,14} An oral LD₅₀ for Sodium Silicate in male mice was 6600 mg/kg.¹¹ Orally administered Aluminum Calcium Sodium Silicate had no adverse effects when tested up to 800 mg/kg in mice.^{56,57} In an inhalation study, the LC₅₀ for Potassium Silicate (30%) was > 2060 mg/m³ following 4.4 h.⁹

Short-Term, Subchronic, and Chronic Toxicity Studies**Synthetically-Manufactured Amorphous Silica and Hydrated Silica****Inhalation**

In short-term inhalation studies with Hydrated Silica, inflammatory and pulmonary lesions were observed in rats at 30 mg/m³. Inflammatory responses were also observed in rats exposed to Silica in studies that lasted between 5 to 14 d. No significant lung histopathological findings or adverse changes in inflammatory markers were observed in rats that were exposed to nanoparticle Silica (particle size 50 - 79 nm; concentrations 0.4 - 5.4 mg/m³) for 4 wk. In subchronic inhalation studies, inflammatory responses were noted in the lungs and lymph nodes along with pulmonary lesions after exposure to Hydrated Silica at 35 mg/m³ (particle and agglomerate/aggregate size 1 to ~120 μm). In a 13-wk inhalation study of Silica in rats, the NOEL was 1.3 mg/m³. Inflammation and pulmonary lesions, including fibrosis, were noted in this study and another 13-wk rat study (fibrosis subsided during recovery). In inhalation studies of 9- to 12-mo duration, Hydrated Silica caused pulmonary inflammation and emphysema in rats exposed to 25 to 85 mg/m³. The LOAEC in rabbits exposed for 9 mo to Hydrated Silica was 28 mg/m³. No silicotic processes were noted in studies of rabbits, rats, and guinea pigs exposed to an average of 126 mg/m³ Hydrated Silica for 12, 15, and 24 mo, respectively. No neoplasia was observed. In a 12-mo study with

Hydrated Silica and Silica in rats, the LOAEC was 6.9 mg/m³ due to interstitial fibrosis (which was comparable between test and control groups). The same test materials also were associated with nodular fibrosis in an 18-mo study with monkeys, although the animals may have been exposed to quartz or asbestos fibers. The LOAEC in a 6-mo rat inhalation study with Silica was 53 mg/m³. Emphysema and fibrosis were noted around 4 mo of exposure. Inflammatory responses and pulmonary lesions were noted in rat, guinea pigs, rabbits, and monkeys in studies up to 24 mo in duration. More than half of the studies summarized in this report included recovery periods of various durations that showed that observed lung effects began to resolve or did not worsen after exposure ceased.

Silicates

In short-term oral toxicity studies, no adverse effects were seen in mice or rabbits dosed up to 5 g/kg Magnesium Aluminum Silicate; beagle dogs and rats fed 1.3 g/kg/d Aluminum Silicate had no renal lesions.¹ Dogs and rats fed 1.8 g/kg/d Magnesium Trisilicate for 4 wk had polydipsia and polyuria, and all dogs had renal cortical lesions. Guinea pigs had renal lesions after 4 mo of drinking Magnesium Trisilicate (250 mg/L) in tap water. Rats fed 10% Magnesium Aluminum Silicate had slightly elevated silicon levels of the spleen and dogs and rats fed 10% Magnesium Aluminum Silicate had no adverse effects in 90-d feeding studies. Beagle dogs fed 2.4 g/kg/d of Sodium Silicate for 4 wk had gross renal lesions but no impairment of renal function.²

DEVELOPMENTAL AND REPRODUCTIVE TOXICITY (DART) STUDIES

Calcium Silicate (250 to 1600 mg/kg on gestation days 6 through 18) had no discernible effect on nidation or on maternal or fetal survival in rabbits.¹ Magnesium Aluminum Silicate (600 to 6000 mg/kg on gestation days 7 through 12) had no adverse effects on the mouse fetus.

Rats given Sodium Silicate (600 and 1200 ppm of added silica) in the drinking water in reproductive studies had a reduced number of offspring; 67% of controls at 600 ppm and 80% of controls at 1200 ppm.² Three adult rats injected intratesticularly and subcutaneously with 0.8 mM/kg of Sodium Silicate showed no morphological changes in the testes and no effect on the residual spermatozoa in the ductus deferens.

GENOTOXICITY STUDIES

No increase in mutation frequencies was seen in the Salmonella TA-1530 or G-46 assay and no significant increase in recombinant activity was observed in the Saccharomyces D3 assay with Calcium Silicate.¹ In the *S. typhimurium* LT2 spot test (TA98, TA100, TA1535, TA1537, and TA1538) with or without metabolic activation, Magnesium Aluminum Silicate was found to be non-mutagenic. A subacute dose of 150 mg/kg of Calcium Silicate in rats produced 3% breaks in bone marrow cells arrested in c-metaphase. In a metaphase spread of rat bone marrow cells, Calcium Silicate produced no significant increase in the number of aberrations compared to controls, and in a rat dominant lethal assay, it did not induce any dominant lethal mutations. Routes of administration were not reported for these rat studies.

Sodium Metasilicate was non-mutagenic in a DNA damage and repair assay without metabolic activation using *Bacillus subtilis*.² Sodium Silicate was non-mutagenic in studies using *Escherichia coli* strains B/Sd-4/1,3,4,5 and B/Sd-4/3,4.

Genotoxicity data are summarized in Table 7. Aluminum Silicate and Sodium Metasilicate were not genotoxic in Ames tests or a hypoxanthine-guanine phosphoribosyl transferase (HGPRT) gene mutation assays, Sodium Silicate was not genotoxic in a HGPRT gene mutation assay or a chromosome aberration test, and Zinc Silicate was not genotoxic in an Ames test.^{7,10-12}

Mutagenic Inhibition

Aluminum Calcium Sodium Silicate

In a study of mutagenic inhibition, aflatoxin (2.5 mg/kg) was incorporated into rat feed with Aluminum Calcium Sodium Silicate (hydrated; 0.5%).⁴⁶ The feed was given to groups of 10 Sprague-Dawley rats for 15 d, after which the animals were killed and bone marrow samples were collected for chromosomal analysis. In the marrow of the rats given aflatoxin alone, structural and numerical aberrations of chromosomes, mainly chromatid breaks and chromatid gaps, were observed. In the rats that received Aluminum Calcium Sodium Silicate, these effects were decreased for every category of aberration except polyploidy.

CARCINOGENICITY STUDIES

No carcinogenicity studies were discovered in the published literature, and no unpublished data were submitted.

OTHER RELEVANT STUDIES

Cytotoxicity

A sample of Aluminum Silicate in an in vitro assay was toxic to pulmonary alveolar macrophages, and lactate dehydrogenase activity (LDH) and β -galactosidase (β -GAL) release were increased.¹

DERMAL IRRITATION AND SENSITIZATION STUDIES

Magnesium Aluminum Silicate (4%) was a weak primary skin irritant in rabbits and had no cumulative skin irritation in guinea pigs.¹ No gross effects were reported in any of the studies. Sodium Magnesium Silicate (4%) had no primary skin irritation in rabbits and had no cumulative skin irritation in guinea pigs.¹ Dermal irritation of Potassium Silicate, Sodium Metasilicate, and Sodium Silicate ranged from negligible to severe, depending on the species tested and the molar ratio and concentration tested.² Sodium Metasilicate was negative in the local lymph node assay (LLNA) at up to 6%, but a delayed-type hypersensitivity response was observed to the test material in mice sensitized at 4% and challenged at 6%.

Applications of 2 g of Magnesium Aluminum Silicate made to the skin of two humans daily for 1 wk caused no effects.¹ Sodium Metasilicate/carbonate detergent (37% Sodium Metasilicate) mixed 50/50 with water was considered a severe skin irritant when tested on intact and abraded human skin.² Detergents containing 7%, 13%, and 6% Sodium Silicate mixed 50/50 with water, however, were negligible skin irritants to intact and abraded human skin. Sodium Silicate (10% of a 40% aqueous solution) was negative in a human repeat-insult patch test (HRIPT). The same aqueous solution of Sodium Silicate was considered mild under normal use conditions in a study of cumulative irritant properties. Sodium Metasilicate and Sodium Silicate were studied in modified soap chamber tests. No burning or itching was observed and low erythema + edema scores were noted. Sodium Metasilicate and Sodium Silicate, tested in elbow crease studies and semi-occluded patch tests, produced low grade and transient irritation.

Dermal irritation and sensitization data summarized here are detailed in Table 8. Aluminum Silicate and Zinc Silicate were predicted to be not irritating in EpiDerm™ skin assays.^{7,12} In rabbit studies, the irritation potential of Potassium Silicate (up to 36%) and Sodium Metasilicate (up to 97%) were dependent on concentration, with irritation observed starting at 33% for Potassium Silicate and slight irritation starting at 10% for Sodium Metasilicate.^{9,10,14} Aluminum Silicate (up to 25%) and Zinc Silicate (up to 50%) were not sensitizing in LLNA studies.^{7,12} Potassium Silicate (30%) was not sensitizing in guinea pig sensitization test.⁹

OCULAR IRRITATION STUDIES

A 4% solution of Magnesium Aluminum Silicate and a 4% solution of Sodium Magnesium Silicate caused minimal eye irritation in a Draize eye irritation test.¹

Potassium Silicate was nonirritating in two acute eye irritation studies in rabbits.² Sodium Metasilicate (42.4% water) was corrosive to the rabbit eye. Sodium Silicate was a severe eye irritant in acute eye irritation studies. A skin freshener (10% of a 40% aqueous solution) containing Sodium Silicate was nonirritating. Sodium Silicate in another three Draize eye irritation studies was highly irritating (at molar ratios of 2 and 2.9 and concentrations of 44% and 43%), irritating (at molar ratios of 1 and 2 and concentrations of 10% and 8%), and nonirritating (at molar ratio of 3.2 and concentration of 36%), respectively.

In vitro and animal ocular irritation data are summarized in Table 9. Aluminum Silicate (tested pure) was predicted to be not irritating using the hen's egg test chorioallantoic membrane (HET-CAM) method.¹² Sodium Metasilicate (undiluted) was predicted to be corrosive in the isolated rabbit eye study,¹⁰ and Zinc Silicate (20%) was predicted to be irritating in a bovine corneal opacity and permeability (BCOP) test.⁷ Potassium Silicate was not irritating, at concentrations up to 29%, to slightly irritating, at 30% and 35%, in rabbit eyes.^{9,14}

CLINICAL STUDIES

Case Reports

Colloidal Sodium Metasilicate (0.5 l) was fatal to one man and neutralized Sodium Silicate (more than 1 g/kg) produced vomiting, diarrhea, and gastrointestinal bleeding in another man in separate case reports of oral ingestion.²

Sodium Metasilicate

Acute kidney injury was reported in a 52-yr-old man who had ingested approximately 150 ml of a plate developer solution containing Sodium Metasilicate.⁵⁸ The patient also developed severe upper airway obstruction due to laryngeal edema, severe inflammation of the upper gastrointestinal tract with narrowing of the esophagus and pyloric region. The patient succumbed to his injuries a few months after ingestion.

Reactive airway dysfunction syndrome was reported in a 43-yr-old man who had inhaled dishwasher detergent powder containing Sodium Metasilicate.⁵⁹ The patient was employed as an apprentice cook and accidentally inhaled the detergent while preparing to use an institutional dishwasher.

Occupational and Environmental Exposure

While no occupational exposure data to the specific silicate ingredients were discovered, general data on amorphous and crystalline silica exist in the published literature. Occupational data on amorphous silica has been summarized in the synthetically-manufactured amorphous silica and hydrated silica safety assessment.⁵ Available regulatory information data on silica is provided below.

According to the Agency for Toxic Substances and Disease Registry (ATSDR), data from occupational exposure studies are insufficient to determine whether or not amorphous silica is associated with adverse effects in humans because exposure in most studies included a mixture of crystalline and amorphous silica.⁶⁰ The ATSDR noted that results of animal studies on synthetic amorphous silica polymorphs indicate that inhalation exposure is associated with pulmonary toxicity: however, progressive fibrosis was not observed and most effects were reversible. Because NOAEL and LOAEL values could not be certainly identified, an inhalation minimal risk level (MRL) for amorphous silica could not be developed for any exposure duration. For crystalline silica, the ATSDR noted that while this substance is associated with silicosis and other pulmonary disease, an inhalation MRL could not be developed due to the inability to determine a no-effect level.

The ATSDR also reported that both amorphous and crystalline silica can be found in ambient air through release by natural and human processes.⁶⁰ Ambient amorphous silica levels have been found to range from $<0.2 \mu\text{g}/\text{m}^3$ to $135 \mu\text{g}/\text{m}^3$, and ambient urban crystalline silica levels have been found to range from $0.25 \mu\text{g}/\text{m}^3$ to $2.87 \mu\text{g}/\text{m}^3$.

The Occupational Safety and Health Administration (OSHA) action level for crystalline silica is $25 \mu\text{g}/\text{m}^3$ averaged over an 8-h day.⁶¹ The permissible exposure limit (PEL) for crystalline silica is $50 \mu\text{g}/\text{m}^3$. For amorphous silica, the PEL is $80 \text{mg}/\text{m}^3$ or 20 million particles per cubic foot air averaged over an 8-h work shift.⁶²

The National Institute for Occupational Safety and Health (NIOSH) recommended exposure limit (REL) is $0.05 \text{mg}/\text{m}^3$ for crystalline silica and $6 \text{mg}/\text{m}^3$ for amorphous silica.⁶³

The California Office of Environmental Health Hazard Assessment (OEHHA) has set a chronic inhalation reference exposure level) of $3 \mu\text{g}/\text{m}^3$ for crystalline silica (silicon dioxide, quartz, tridymite, cristobalite) based on occupational exposure studies of crystalline silica and the development of silicosis in miners and other related occupations.⁶⁴

SUMMARY

This report assesses the safety of 24 silicate ingredients as used in cosmetics. The majority of these ingredients function as abrasives, absorbents, bulking agents, and/or deodorant agents in cosmetic products. The Panel previously reviewed the safety of Aluminum Silicate, Calcium Silicate, Magnesium Silicate, Magnesium Trisilicate, Sodium Magnesium Silicate, Zirconium Silicate, Lithium Magnesium Silicate, and Lithium Magnesium Sodium Silicate in a report that was published in 2003; the Panel concluded that these ingredients are safe as used in cosmetic products. In accordance with its procedures, the Panel evaluates the conclusions of previously-issued reports every 15 years, and it has been at least 15 years since this assessment has been issued. This report has been reopened to add additional ingredients, including several that were also previously reviewed. A report on Potassium Silicate, Sodium Metasilicate, and Sodium Silicate was published in 2005 with the conclusion that these ingredients are safe for use in cosmetic products in the practices of use and concentration described in the safety assessment when formulated to avoid irritation. A report on Alumina Magnesium Metasilicate (now called Magnesium Aluminometasilicate), Aluminum Iron Silicates, and Sodium Potassium Aluminum Silicate was finalized by the Panel in 2009, with the conclusion that these ingredients are safe as cosmetic ingredients in the practices of use and concentrations as described in the safety assessment.

These silicate ingredients that are inorganic oxides, comprising in part, silicon dioxide, are solids that can be derived from naturally occurring minerals. However, the ingredients in this safety assessment can be produced synthetically. The Panel considered the method of manufacture of these ingredients (whether synthetic or mined) to be of significant importance to safety, as synthetically derived ingredients are expected to have controlled material formation (i.e. exclusion of crystalline formation).

According to 2021 VCRP data, Magnesium Aluminum Silicate has the most reported uses in cosmetic products, with a total of 383; the majority of the uses are in leave-on eye makeup preparations and skin care preparations. Aluminum Calcium Sodium Silicate has the second most reported uses in cosmetic products, with a total of 103; the majority of the uses are in lipsticks. (The reported numbers of uses for the remaining ingredients in this report are much lower.) The frequencies of use for both of these ingredients have greatly changed since the original safety assessments were finalized; in 1998, Magnesium Aluminum Silicate was reported to have 632 uses, and in 2009, Aluminum Calcium Sodium Silicate was reported to have 7 uses. The results of the concentration of use survey conducted in 2018 by the Council indicate Aluminum Calcium Sodium Silicate has the highest reported maximum concentration of use for leave-on products; it is used at up to 26.3% in eye shadows.

Magnesium Silicate is reported to have a maximum concentration of use for leave-on products of 21.6% in eye shadows. According to the original safety assessment, the maximum use concentration in 2008 for Aluminum Calcium Sodium Silicate was 6% in foundations and lipsticks. Additionally, according to 1999 data, there were no reported uses for Magnesium Silicate.

Potassium Silicate (30% solution in water) had a dermal LD₅₀ > 5 g/kg in rats. In oral rat studies, the LD₅₀s were > 2 g/kg for Aluminum Silicate (concentration not reported), Sodium Magnesium Aluminum Silicate (concentration not reported), and Sodium Silicate. Calcium Silicate (20%) and Potassium Silicate (concentration not reported) had LD₅₀s of > 10 g/kg and > 5 g/kg in rats, respectively. An oral LD₅₀ for Sodium Silicate in mice was 6.60 g/kg. Orally administered Aluminum Calcium Sodium Silicate had no adverse effects when tested up to 0.8 g/kg in mice. In an inhalation study, the LC₅₀ for Potassium Silicate (30%) was > 2060 mg/m³ following 4.4 h.

Aluminum Silicate, Sodium Metasilicate, Sodium Silicate, and Zinc Silicate were not genotoxic in Ames tests, HGPRT gene mutation assays, or chromosome aberration tests. Aluminum Calcium Sodium Silicate (hydrate; 0.5%) inhibited chromosomal aberrations (except polyploidy) in rats that received the test material and aflatoxin in feed. No carcinogenicity studies on the silicate ingredients were discovered in the published literature, and no unpublished data were submitted.

Aluminum Silicate and Zinc Silicate were predicted to be not irritating in EpiDerm™ skin assays. In rabbit studies, the irritation potential of Potassium Silicate (up to 36%) and Sodium Metasilicate (up to 97%) were dependent on concentration, with irritation observed starting at 33% for Potassium Silicate and slight irritation starting at 10% for Sodium Metasilicate. Aluminum Silicate (up to 25%) and Zinc Silicate (up to 50%) were not sensitizing in LLNA studies. Potassium Silicate (30%) was not sensitizing in guinea pig sensitization tests.

Aluminum Silicate (tested pure) was predicted to be not irritating using the hen's egg test chorioallantoic membrane (HET-CAM) method. Sodium Metasilicate (undiluted) was predicted to be corrosive in the isolated rabbit eye study, and Zinc Silicate (20%) was predicted to be irritating in a bovine corneal opacity and permeability (BCOP) test. Potassium Silicate was not irritating, at concentrations up to 29%, to slightly irritating, at 30% and 35%, in rabbit eyes.

Case reports of severe injury were reported from ingestion and inhalation of Sodium Metasilicate.

Occupational exposure limits for amorphous and crystalline silica have been set by OSHA, NIOSH, and the California OEHHA. Silica exists in ambient air at ranges of <0.2 µg/m³ to 135 µg/m³ for amorphous silica and 0.25 µg/m³ to 2.87 µg/m³ for crystalline silica (urban air).

DISCUSSION FROM 2019 SYNTHETICALLY-MANUFACTURED AMORPHOUS SILICA AND HYDRATED SILICA REPORT

The Panel assessed the safety of synthetically-manufactured amorphous Silica and Hydrated Silica, and considered the method of manufacture of these ingredients (synthetic and not mined) to be of significant importance when reviewing safety.⁵ The Panel emphasized that this report reviews only the safety of synthetically-manufactured amorphous Silica and Hydrated Silica. Crystalline silica, and synthetic and mined silicates are not toxicologically similar to synthetically-manufactured amorphous Silica and Hydrated Silica, and thus require separate reviews.

Data were sufficient to assess the safety of synthetically-manufactured amorphous Silica and Hydrated Silica, and the Panel determined that these two ingredients do not pose an incidental inhalation safety risk, under conditions of cosmetic use. The exposures that were tested in inhalation studies were at much higher concentrations than those possible with cosmetic use, and had very few adverse effects. Aggregation and agglomeration of Silica and Hydrated Silica particles in cosmetic formulations reduces potential inhalation exposure. While the Panel noted the effects on trachea-bronchial lymph nodes in mice, the carcinogenicity study used such high concentrations of Hydrated Silica that the effects were due to the overload of the animal system; therefore, concern over incidental inhalation of Silica in cosmetics was mitigated.

The Panel was concerned, however, that the potential exists for dermal and ocular irritation with the use of products formulated using Silica and Hydrated Silica. Therefore, the Panel specified that products containing these ingredients must be formulated to be non-irritating.

DRAFT DISCUSSION

[Please note, this discussion is in draft form and will be modified following the meeting.]

The Panel assessed the safety of silicate ingredients. These inorganic oxides, comprising in part, silicon dioxide, are solids that can be derived from naturally occurring minerals or can be produced synthetically. The Panel considered the method of manufacture of these ingredients (whether synthetic or mined) to be of significant importance to safety, as synthetically derived ingredients are expected to have controlled crystalline material formation.

The Panel expressed concern that the potential exists for dermal and respiratory irritation with the use of products formulated using silicate ingredients. Therefore, the Panel specified that products containing these ingredients must be formulated to be non-irritating.

The Panel also expressed concern about the potential exposure to low concentrations of respirable crystalline silica from spray and powder products formulated with silicate ingredients. The concentrations of respirable crystalline silica potentially released by a cosmetic product should be controlled by using ingredients that contain little or no crystalline silica, limiting the concentration of the ingredient containing crystalline silica, and/or limiting the respirable particle fraction released by the product, consistent with good manufacturing practices (GMPs).

Remaining discussion to be determined...

CONCLUSION

To be determined...

TABLES**Table 1. Definitions and reported functions of the ingredients in this safety assessment.⁴**

Ingredient & CAS No.	Definition	Function(s)
Aluminum Calcium Sodium Silicate 1344-01-0	Aluminum Calcium Sodium Silicate is a complex silicate refined from naturally occurring minerals.	Bulking Agents
Aluminum Iron Calcium Magnesium Germanium Silicates	Aluminum Iron Calcium Magnesium Germanium Silicates is a ceramic powder consisting mainly of silicon dioxide, aluminum oxide, ferric oxide, calcium oxide, magnesium oxide and germanium oxide.	Anticaries Agents; Antifungal Agents; Antimicrobial Agents; Antioxidants
Aluminum Iron Calcium Magnesium Zirconium Silicates	Aluminum Iron Calcium Magnesium Zirconium Silicates is a ceramic powder consisting mainly of silicon dioxide, aluminum oxide, ferric oxide, calcium oxide, magnesium oxide and zirconium oxide.	Bulking Agents
Aluminum Iron Silicates	Aluminum Iron Silicates is a ceramic powder consisting mainly of silicon dioxide, aluminum oxide, and ferric oxide.	Abrasives; Bulking Agents
Aluminum Silicate 1327-36-2	Aluminum Silicate is a complex inorganic salt that has a composition consisting generally of 1 mole of alumina and 1 to 3 moles of silica.	Abrasives; Absorbents; Anticaking Agents; Bulking Agents; Opacifying Agents; Slip Modifiers
Ammonium Silver Zinc Aluminum Silicate	Ammonium Silver Zinc Aluminum Silicate is a complex silicate formed from the reaction of zinc nitrate, Ammonium Nitrate, and Silver Nitrate with zeolite.	Absorbents; Deodorant Agents; Preservatives
Calcium Magnesium Silicate 12765-06-9	Calcium Magnesium Silicate is a synthetic silicate clay consisting chiefly of calcium and magnesium silicates	Absorbents; Deodorant Agents
Calcium Silicate 1344-95-2	Calcium Silicate is a hydrous or anhydrous silicate with varying proportions of calcium oxide and silica.	Absorbents; Bulking Agents; Opacifying Agents
Lithium Magnesium Silicate 37220-90-9	Lithium Magnesium Silicate is a synthetic silicate clay consisting mainly of lithium and magnesium silicates.	Binders; Bulking Agents; Viscosity Increasing Agents - Aqueous
Lithium Magnesium Sodium Silicate 53320-86-8	Lithium Magnesium Sodium Silicate is a synthetic silicate clay consisting mainly of lithium, magnesium and sodium silicates.	Bulking Agents; Viscosity Increasing Agents - Aqueous
Magnesium Aluminometasilicate 12408-47-8	Magnesium Aluminometasilicate is the inorganic compound consisting of varying amounts of magnesium oxide, aluminum oxide and silica.	Absorbents; Anticaking Agents; Bulking Agents; Opacifying Agents; Slip Modifiers; Viscosity Increasing Agents – Aqueous; Viscosity Increasing Agents – Nonaqueous
Magnesium Aluminum Silicate 12199-37-0 12511-31-8	Magnesium Aluminum Silicate is a complex silicate refined from naturally occurring minerals.	Absorbents; Anticaking Agents; Bulking Agents; Opacifying Agents; Slip Modifiers; Viscosity Increasing Agents - Aqueous
Magnesium Silicate 1343-88-0	Magnesium Silicate is an inorganic salt of variable composition which consists mainly of $MgO \cdot SiO_2 \cdot xH_2O$.	Absorbents; Anticaking Agents; Bulking Agents; Opacifying Agents; Slip Modifiers; Viscosity Increasing Agents - Aqueous
Magnesium Trisilicate 14987-04-3	Magnesium Trisilicate is the inorganic compound that conforms generally to the formula $2MgO \cdot 3SiO_2 \cdot xH_2O$.	Abrasives; Absorbents; Anticaking Agents; Bulking Agents; Opacifying Agents; Slip Modifiers; Viscosity Increasing Agents - Aqueous
Potassium Silicate 1312-76-1	Potassium Silicate is a potassium salt of silicic acid.	Corrosion Inhibitors
Pyrophyllite 113349-10-3; 113349-11-4; 113349-12-5; 12269-78-2; 141040-73-5; 141040-74-6	Pyrophyllite is a naturally occurring mineral substance consisting predominantly of a hydrous aluminum silicate represented as $Al_2O_3 \cdot 4SiO_2 \cdot H_2O$.	Absorbents; Colorants; Opacifying Agents
Sodium Magnesium Silicate	Sodium Magnesium Silicate is a synthetic silicate clay with a composition mainly of magnesium and sodium silicate.	Binders; Bulking Agents
Sodium Magnesium Aluminum Silicate 12040-43-6	Sodium Magnesium Aluminum Silicate is the complex silicate obtained by the reaction of Sodium Silicate and Sodium Aluminate in an aqueous solution of Magnesium Nitrate.	Absorbents
Sodium Metasilicate 6834-92-0	Sodium Metasilicate is the inorganic salt that conforms to the formula Na_2SiO_3 .	Chelating Agents; Corrosion Inhibitors
Sodium Potassium Aluminum Silicate 12736-96-8; 66402-68-4	Sodium Potassium Aluminum Silicate is a complex silicate refined from naturally occurring minerals, or derived synthetically.	Bulking Agents
Sodium Silicate 1344-09-8	Sodium Silicate is a sodium salt of silicic acid.	Buffering Agents; Corrosion Inhibitors; pH Adjusters
Sodium Silver Aluminum Silicate	Sodium Silver Aluminum Silicate is the complex silicate obtained by the reaction of sodium silicate with sodium aluminate in an aqueous solution of sodium nitrate, sodium hydroxide and silver nitrate.	Absorbents; Deodorant Agents
Zinc Silicate 13597-65-4	Zinc Silicate is an inorganic salt consisting of variable amounts of zinc oxide and silica.	Deodorant Agents
Zirconium Silicate 10101-52-7 1344-21-4	Zirconium Silicate is the inorganic compound that conforms to the formula $ZrSiO_4$.	Abrasives; Opacifying Agents

Table 2. Chemical properties

Property	Value	Reference
<i>Aluminum Silicate</i>		
Physical Form	Light brown to brown, odorless beads	12
Formula Weight (Da)	162.05 - 426.05	1
Density (g/ml @ 20°C)	3.156; 3.247	1
<i>Calcium Silicate</i>		
Physical Form	White or slightly cream-colored free-flowing powder	1
Formula Weight (Da)	116.16	1
Density (g/ml @ 25°C)	0.227	13
Melting Point (°C)	1710	13
Water Solubility (mg/l @ 20°C)	260	13
pH	8.4-12.5 (5% slurry)	22
<i>Magnesium Aluminum Silicate</i>		
Physical Form	Off-white to creamy white small flakes or micronized powder	1
Formula Weight (Da)	262.4	1
pH	9.0-10.0 (5% aqueous solution)	1
<i>Magnesium Silicate</i>		
Physical Form	Fine, white, odorless, tasteless powder, free from grittiness	1
pH	7.0-11.0 (1 in 10 slurry)	23
<i>Magnesium Trisilicate</i>		
Physical Form	Fine, white, odorless, tasteless powder, free from grittiness	1
<i>Potassium Silicate</i>		
Physical Form	Yellowish to colorless, translucent to transparent, hygroscopic	2
Density (g/ml @ 20°C)	1.26-1.60	9
Vapor Pressure (mmHg @ 1175°C)	0.00772	9
Melting Point (°C)	905	9
<i>Sodium Magnesium Silicate</i>		
pH	8.5-10.5 (2% aqueous dispersion)	1
<i>Sodium Magnesium Aluminum Silicate</i>		
Physical Form	White powder	8
Density (g/ml @ 20°C)	2.11	8
Melting Point (°C)	> 400	8
Water Solubility (mg/l @ 20°C)	2.24	8
<i>Sodium Metasilicate</i>		
Physical Form	Nonahydrate, efflorescent platelets	2
Formula Weight (Da)	122.08	2
Density (g/ml)	2.614	2
Vapor Pressure (mmHg @ 1175°C)	0.00772	10
Melting Point (°C)	1089	2
Water Solubility (g/l @ 20 °C)	210	10
pH	12 (0.1% solution)	2
<i>Sodium Silicate</i>		
Physical Form	Colorless to white or grayish-white, crystal-like clumps or aqueous solutions	2
Density (g/ml)	1.26 - 1.71	11
Vapor Pressure (mmHg)	0.00120	11
Melting Point (°C)	730 - 870	11
Water Solubility (mg/l @ 20 °C)	115	11
Acidity/Alkalinity	Strongly alkaline	2
<i>Zinc Silicate</i>		
Physical Form	White crystals or white powder	52,53
Formula Weight (Da)	222.90	53
Density (g/ml)	4.103	52
Melting Point (°C)	1509	52
Water Solubility (µg/l @ 20 °C)	162.01	7
<i>Zirconium Silicate</i>		
Physical Form	Bipyramidal crystals, colorless unless has impurities and radioactive bombardment; red or various colored crystals	1
Formula Weight (Da)	183.31	1
Density (g/ml)	4.56	1
pH	6-7.5 (10% aqueous slurry)	1

Table 3. Method of manufacturing and product specifications for silicate ingredients.¹⁵

Ingredient	Form	Typical Particle Size	Crystallinity	Method of Manufacturing	Purity	Reference
Calcium Silicate	Powder solid	2-30 µm	< 0.2%	Reaction of Sodium Silicate and a calcium source in solution. The suspension received from the reaction is filtered and the Calcium Silicate is further washed and dried.	Purity typically in accordance with JECFA specification; not specifically marketed for cosmetics use.	¹⁵
Calcium Silicate (generic)	NR	NR	NR	Manufactured from diatomaceous earth or precipitated silica; diatomaceous earth-based products are produced through hydrothermal reaction processes, which combine natural, or flux-calcined diatomaceous earth with hydrated lime to produce synthetic mineral forms of gyrolite and tobermorite; in precipitated or other silica-based products, Calcium Silicate is produced by reacting Sodium Silicate and calcium oxide.	NR	¹⁶
Magnesium Silicate	Powder solid	3-20 µm, some grades larger	< 0.2%	Reaction of Sodium Silicate and a magnesium source in solution. The suspension received from the reaction is filtered and the Magnesium Silicate is further washed and dried	Purity typically in accordance with JECFA specification; not specifically marketed for cosmetics use.	¹⁵
Magnesium Aluminum Silicate	NR	NR	NR	Obtained by mining; material undergoes several processing steps after being extracted from the Earth, including washing, drying, and milling in order to obtain a product with uniform characteristics.	NR	¹⁷
Potassium Silicate	Liquid	NA – Liquid	< 0.1%	Reaction of sand and potassium carbonate, reaction is dissolved, filtered, and sold as a liquid.	Impurities originate in the raw materials. Typical total impurity levels are less than 500 ppm.	¹⁵
Sodium Magnesium Silicate	NR	NR	NR	Hydrothermal synthesis from silicon, sodium, and magnesium sources	NR	¹⁸
Sodium Metasilicate	Powder	212-859 µm	< 0.1%	Sodium Metasilicate is made by adding caustic soda to liquid Sodium Silicate to obtain an equal molar ratio of sodium oxide to sodium dioxide. The resulting metasilicate liquor is then cooled to crystallize the pentahydrate product or passed through a dryer to remove water and yield the anhydrous product.	Impurities originate in the raw materials. Typical total impurity levels are less than 500 ppm.	¹⁵
Sodium Silicate (hydrous)	Powder or granules	80-700 µm	< 0.1%	Reaction of sand and sodium carbonate at high temperature, reaction is dissolved, filtered, and spray dried to make powder	Impurities originate in the raw materials. Typical total impurity levels are less than 500 ppm.	¹⁵
Sodium Silicate	Liquid	NA – Liquid	< 0.1%	Reaction of sand and sodium carbonate at high temperatures, reaction is dissolved, filtered, and sold as a liquid.	Impurities originate in the raw materials. Typical impurity levels are less than 500 ppm.	¹⁵
Sodium Silver Aluminum	NR	NR	NR	Obtain by reaction of nitric acid, sodium hydroxide, and sodium aluminate with Sodium Silicate (water glass) in ion exchange water at 100° C; resulting solution is then reacted with silver nitrate and dried at 150° C.	NR	¹⁹

JECFA = Joint Food and Agriculture Organization of the United Nations (FAO)/World Health Organization (WHO) Expert Committee on Food Additives

NA = Not applicable NR = Not reported

Table 4. Current and historical frequency and concentration according to duration and type of exposure for previously reviewed silicates.^{1-3,25-27}

	Aluminum Silicate				Aluminum Calcium Sodium Silicate			
	# of Uses		Max Conc of Use (%)		# of Uses		Max Conc of Use (%)	
	2021	1998	2018	1999	2021	2009	2018	2008
Totals*	5	10	2.8-4.6	0.5-37	103	7	0.0001-26.3	0.4-6
Leave-On	4	6	NR	0.5-3	101	7	0.0001-26.3	0.4-6
Rinse-Off	1	4	2.8-4.6	2-37	2	NR	NR	NR
Diluted for (Bath) Use	NR	NR	NR	NR	NR	NR	NR	NR
Eye Area	NR	2	NR	0.5	10	NR	0.006-26.3	0.5
Incidental Ingestion	NR	NR	NR	37	59	NR	3.5-5.5	6
Incidental Inhalation-Spray	1; 2 ^a	1 ^a	NR	NR	1; 9 ^a ; 1 ^b	1 ^a	NR	NR
Incidental Inhalation-Powder	NR	NR	NR	NR	1 ^b	1	NR	NR
Dermal Contact	2	8	2.8-4.6	2-3	33	3	0.006-26.3	0.4-6
Deodorant (underarm)	NR	NR	NR	NR	NR	NR	NR	NR
Hair - Non-Coloring	1	NR	NR	NR	3	NR	NR	NR
Hair-Coloring	2	NR	NR	NR	NR	NR	NR	NR
Nail	NR	NR	NR	NR	8	4	0.0001-0.25	0.5
Mucous Membrane	NR	NR	4.6	37	59	NR	3.5-5.5	6
Baby Products	NR	NR	NR	NR	NR	NR	NR	NR
	Ammonium Silver Zinc Aluminum Silicate				Calcium Silicate			
	# of Uses		Max Conc of Use (%)		# of Uses		Max Conc of Use (%)	
	2021	NA	2018	NA	2021	1998	2018	1999
Totals*	27	NA	0.001	NA	28	132	0.00013-20	0.3-10
Leave-On	27	NA	NR	NA	27	115	0.00013-5	0.3-10
Rinse-Off	NR	NA	0.001	NA	1	1	1.5-20	8
Diluted for (Bath) Use	NR	NA	NR	NA	NR	16	0.86-1.3	NR
Eye Area	19	NA	NR	NA	2	11	1	1-8
Incidental Ingestion	NR	NA	NR	NA	NR	3	0.00013	0.5
Incidental Inhalation-Spray	NR	NA	NR	NA	1 ^a ; 1 ^b	NR	0.005	NR
Incidental Inhalation-Powder	2	NA	NR	NA	16; 1 ^b	75	0.25-5; 4.7-5 ^c	0.3-10
Dermal Contact	27	NA	0.001	NA	28	128	0.25-20	0.3-10
Deodorant (underarm)	NR	NA	NR	NA	NR	NR	NR	NR
Hair - Non-Coloring	NR	NA	NR	NA	NR	NR	1.5	NR
Hair-Coloring	NR	NA	NR	NA	NR	NR	0.005	NR
Nail	NR	NA	NR	NA	1	1	NR	NR
Mucous Membrane	NR	NA	NR	NA	9	19	0.00013-1.3	0.5
Baby Products	NR	NA	NR	NA	NR	NR	NR	NR

Table 4. Current and historical frequency and concentration according to duration and type of exposure for previously reviewed silicates.^{1-3,25-27}

	Lithium Magnesium Silicate				Lithium Magnesium Sodium Silicate			
	# of Uses		Max Conc of Use (%)		# of Uses		Max Conc of Use (%)	
	2021	1998	2018	1999	2021	1998	2018	1999
Totals*	1	NR	0.3-5	NR	97	NR	0.0005-6	NR
<i>Leave-On</i>	1	NR	0.3-5	NR	95	NR	0.0005-6	NR
<i>Rinse-Off</i>	NR	NR	NR	NR	2	NR	0.4	NR
<i>Diluted for (Bath) Use</i>	NR	NR	NR	NR	NR	NR	NR	NR
Eye Area	NR	NR	NR	NR	13	NR	0.0005-4	NR
Incidental Ingestion	NR	NR	NR	NR	46	NR	NR	NR
Incidental Inhalation-Spray	1 ^b	NR	0.4; 0.3 ^a	NR	1 ^a	NR	6 ^a	NR
Incidental Inhalation-Powder	1 ^b	NR	5 ^c	NR	1	NR	3 ^c	NR
Dermal Contact	1	NR	0.4-5	NR	48	NR	0.0005-4	NR
Deodorant (underarm)	NR	NR	NR	NR	NR	NR	0.5	NR
Hair - Non-Coloring	NR	NR	0.3	NR	NR	NR	6	NR
Hair-Coloring	NR	NR	NR	NR	NR	NR	NR	NR
Nail	NR	NR	NR	NR	2	NR	NR	NR
Mucous Membrane	NR	NR	NR	NR	46	NR	NR	NR
Baby Products	NR	NR	NR	NR	NR	NR	NR	NR
	Magnesium Aluminometasilicate				Magnesium Aluminum Silicate			
	# of Uses		Max Conc of Use (%)		# of Uses		Max Conc of Use (%)	
	2021	2009	2018	2008	2021	1998	2018	1999
Totals*	22	NR	NR	0.002-0.01	383	632	0.0004-11	0.1-5
<i>Leave-On</i>	21	NR	NR	0.002-0.01	303	509	0.0008-11	0.1-5
<i>Rinse-Off</i>	1	NR	NR	NR	80	122	0.0004-10	0.1-5
<i>Diluted for (Bath) Use</i>	NR	NR	NR	NR	NR	1	NR	NR
Eye Area	2	NR	NR	NR	72	76	0.0025-4.5	0.2-5
Incidental Ingestion	NR	NR	NR	NR	1	3	0.93	0.7
Incidental Inhalation-Spray	1 ^{a,b}	NR	NR	0.002-0.01 ^b	67 ^a ; 82 ^b	2; 106 ^a ; 75 ^b	0.5-0.8 ^a	0.3-5 ^{a,b}
Incidental Inhalation-Powder	1 ^b	NR	NR	0.002-0.01 ^b	7; 82 ^b ; 4 ^c	75 ^b	1; 0.3-11 ^c	0.3-5 ^b
Dermal Contact	21	NR	NR	0.002-0.01	360	583	0.0004-11	0.1-5
Deodorant (underarm)	NR	NR	NR	NR	2 ^a	5 ^a	0.5-0.7	0.5-1 ^a
Hair - Non-Coloring	NR	NR	NR	NR	9	10	0.19-0.8	1-2
Hair-Coloring	NR	NR	NR	NR	1	1	NR	2
Nail	NR	NR	NR	NR	NR	2	NR	NR
Mucous Membrane	NR	NR	NR	NR	9	19	0.93	0.5-2
Baby Products	NR	NR	NR	NR	4	NR	NR	NR

Table 4. Current and historical frequency and concentration according to duration and type of exposure for previously reviewed silicates.^{1-3,25-27}

	Sodium Potassium Aluminum Silicate				Sodium Silicate			
	# of Uses		Max Conc of Use (%)		# of Uses		Max Conc of Use (%)	
	2021	2009	2018	2008	2021	2001	2018	1999/2000
Totals*	31	1	0.36-1.1	0.001-4	55	22	0.017-35	0.06-55
<i>Leave-On</i>	31	NR	0.36-1.1	0.001-4	14	2	NR	0.6-1
<i>Rinse-Off</i>	NR	1	NR	NR	41	20	0.017-35	0.06-55
<i>Diluted for (Bath) Use</i>	NR	NR	NR	NR	NR	NR	NR	NR
Eye Area	1	NR	1.1	NR	7	1	NR	NR
Incidental Ingestion	9	NR	NR	NR	2	NR	0.44	0.6
Incidental Inhalation-Spray	9 ^a	NR	NR	NR	1 ^a ; 2 ^b	1 ^b	NR	NR
Incidental Inhalation-Powder	1	NR	0.36 ^c	NR	2 ^b	1 ^b	NR	NR
Dermal Contact	22	1	0.36-1.1	NR	27	14	0.017-1.5	0.06-10
Deodorant (underarm)	NR	NR	NR	NR	NR	NR	NR	NR
Hair - Non-Coloring	NR	NR	NR	NR	2	NR	NR	NR
Hair-Coloring	NR	NR	NR	NR	24	8	15-35	1-55 ^f
Nail	NR	NR	NR	0.001-4	NR	NR	NR	NR
Mucous Membrane	9	NR	NR	NR	3	2	0.44-1.4	0.06-7
Baby Products	NR	NR	NR	NR	NR	NR	NR	0.6

NR = Not reported. NA = Not applicable.

† Because each ingredient may be used in cosmetics with multiple exposure types, the sum of all exposure types may not equal the sum of total uses.

^a It is possible these products may be sprays, but it is not specified whether the reported uses are sprays.^b Not specified whether a powder or a spray, so this information is captured for both categories of incidental inhalation.^c It is possible these products may be powders, but it is not specified whether the reported uses are powders.^d Concentration of use in aerosol deodorants reported to be 0.0001% - 0.084%.^e Hair bleaches were diluted from 13% -18% to 7% -14% before use.^f Hair bleaches were diluted from 16%-55% to 1%-20% before use.**Table 5. Ingredients not reported to be in use.**²⁵⁻²⁷

Aluminum Iron Calcium Magnesium Germanium Silicates

Aluminum Iron Calcium Magnesium Zirconium Silicates

Aluminum Iron Silicates*

Calcium Magnesium Silicate

Magnesium Trisilicate*

Pyrophyllite*

Sodium Magnesium Aluminum Silicate

Sodium Silver Aluminum Silicate

Zinc Silicate

Zirconium Silicate*

*Previously reviewed ingredients in red. Additionally, no uses were reported in original safety assessment.

Table 6. Acute toxicity studies

Ingredient/Concentration/Vehicle	Dose/Study Protocol	Results	LD₅₀ or LC₅₀	Reference
<i>Dermal</i>				
30% Potassium Silicate solution in water; molar ratio = 2.47	5000 mg/kg bw applied for 24 h to 5 male and 5 female Sprague-Dawley rats; test sites were occluded	Erythema and alopecia noted at application site of 4 females and 1 male between days 1 and 8; no other adverse effects during observation period or necropsy	> 5000 mg/kg	⁹
<i>Oral</i>				
Aluminum Calcium Sodium Silicate (hydrated)	400, 600, or 800 mg/kg; 6 female Balb/c mice; no further details	No adverse effects reported	> 800 mg/kg bw	^{56,57}
Aluminum Silicate in water; concentration not reported	2000 mg/kg bw; 3 female Sprague-Dawley rats via gavage	No mortality occurred from dosing; no clinical signs of toxicity; no treatment-related effects at necropsy	> 2000 mg/kg bw	¹²
20% Calcium Silicate in feed	10,000 mg/kg bw; 10 male and 10 female Wistar rats via diet	No mortality occurred from dosing; no significant clinical findings; no treatment-related effects at necropsy	> 10,000 mg/kg bw	¹³
Potassium Silicate; undiluted; no further details reported	5000 mg/kg bw in 3 female Sprague-Dawley rats via gavage	No deaths occurred following treatment; no clinical or gross macroscopic signs of toxicity observed	> 5000 mg/kg bw	⁹
Potassium Silicate; concentration and vehicle not reported	3300, 3960, 4750, 5700, or 6860 mg/kg bw; 5 male and 5 female Cpb; Wu Wistar rats per dose; method of delivery not reported	Deaths per dose = 1/10 at 2.50 ml/kg, 2/10 at 3.00 ml/kg, 2/10 at 3.60 ml/kg, 3/10 at 4.32 ml/kg, and 10/10 at 5.20 ml/kg; sedation, signs of abdominal discomfort, sluggishness and unconsciousness were all reversible; no treatment-related effects at necropsy	5700 mg/kg bw	¹⁴
Sodium Magnesium Aluminum Silicate in water; no further details reported	2000 mg/kg bw in 6 female Sprague-Dawley rats via gavage	No deaths occurred following treatment; no clinical or gross macroscopic signs of toxicity observed	> 2000 mg/kg bw	⁸
Sodium Silicate; molar ratio = 3.35; no additional details provided	Male mice; no additional details provided	No details provided	6600 mg/kg bw	¹¹
Sodium Silicate; molar ratio 3.27; concentration and vehicle not reported	3430, 4110, 4930, 5890, 7120, or 8490 mg/kg bw; 5 male and female Cpb; Wu Wistar rats per dose via gavage	Deaths per dose = 0/10 at 3430 mg/kg, 2/10 at 4110 mg/kg, 9/10 at 4930, 5890, and 7120 mg/kg, and 10/10 at 8490 mg/kg; sedation, signs of abdominal discomfort, sluggishness and unconsciousness; no treatment-related effects at necropsy	5150 mg/kg bw	¹¹
Sodium Silicate; molar ratio = 3.3; no additional details provided	Rats; no additional details provided	No details provided	> 2000 mg/kg bw	¹¹
Sodium Silicate in water; molar ratio = 3.38	Male Wistar rats; no additional details provided	Breathing difficulties, staggering gait, reduced motility; additional effects not reported	8650 mg/kg bw	¹¹
<i>Inhalation</i>				
30% Potassium Silicate solution in water; molar ratio 2.47; particle size distribution = 4% at 9 µm, 8.3% at 5.8 µm, 11.1% at 4.7 µm, 12% at 3.3 µm, 32% at 2.1 µm, 2.6% at 1.1 µm, 7.4% at 0.7 µm, and 2.6% at 0.4 µm)	2060 mg/m ³ ; whole body exposure for 4.4 h to 5 male and 5 female Sprague-Dawley rats	Animals had hunched posture and hypoactivity during exposure that reversed; no deaths or adverse effects during observation period or necropsy	> 2060 mg/m ³	⁹

Table 7. Genotoxicity studies

Ingredient/Concentration/Dose	Species/Strain/Cell	Method	Results	Reference
<i>In Vitro</i>				
Aluminum Silicate in water, up to 5017 µg/plate, with or without metabolic activation	<i>Salmonella typhimurium</i> strains TA97a, TA98, TA100, TA102, and TA1535	Ames test	Not genotoxic	12
Aluminum Silicate in DMSO; up to 250 µg/ml without metabolic activation; up to 500 µg/ml with metabolic activation	Chinese hamster ovary	HGPRT gene mutation assay	Not genotoxic	12
Sodium Metasilicate; up to 5000 µg/plate, with or without metabolic activation	<i>S. typhimurium</i> strains TA98, TA100, TA 1535, TA 1537 and <i>Escherichia coli</i> WP2	Ames test	Not genotoxic	10
Sodium Metasilicate; up to 675 µg/ml without metabolic activation and up to 1800 µg/ml with metabolic activation	Chinese hamster V79 cells	HGPRT gene mutation assay	Not genotoxic	10
36% Sodium Silicate; molar ratio = 3.3; up to 156.3 µg/ml with and without metabolic activation	Chinese hamster V79 cells	Chromosome aberration test	Not genotoxic	11
36% Sodium Silicate; molar ratio = 3.35; up to 675 µg/ml without metabolic activation and up to 1800 µg/ml with metabolic activation	Chinese hamster V79 cells	HGPRT gene mutation assay	Not genotoxic	11
Zinc Silicate; 100, 316, 1000, 3160 or 5000 µg/plate with or without metabolic activation	<i>S. typhimurium</i> strains TA98, TA100, TA102, TA1535, and TA1537	Ames test	Not genotoxic	7

Table 8. Dermal irritation and sensitization

Ingredient/Concentration/ Dose/Vehicle	Test System	Method	Results	Reference
<i>Irritation – In Vitro</i>				
Aluminum Silicate; 25 mg in Dulbecco's phosphate buffered saline	EpiDerm™ tissue	EpiDerm™ human skin model; material applied for 30 min	Not irritating	12
Zinc Silicate; undiluted; 25 mg	EpiDerm™ tissue	EpiDerm™ reconstructed human epidermis model in accordance with OECD Test Guideline 439; test material applied to 0.63 cm ² test tissue for 60 min	Not irritating	7
<i>Irritation – Animal</i>				
25% dilution of 29% (weight) Potassium Silicate; molar ratio = 3.9; 0.5 ml in deionized water	5 New Zealand White rabbits; sex not reported	Dermal irritation study in accordance with OECD Test Guideline 404; test material applied to shaved test site and occluded for 4 h before being rinsed; test site examined for up to 7 d	Not irritating; PDII = 0	9,14
25% dilution of 35% (weight) Potassium Silicate; molar ratio = 3.4; 0.5 ml in deionized water	3 New Zealand White rabbits; sex not reported	Dermal irritation study in accordance with OECD Test Guideline 404; test material applied to shaved test site and occluded for 4 h before being rinsed; test site examined for up to 7 d	Not irritating; very slight erythema 24 and 48 h after treatment; PDII = 0	9,14
29% (weight) Potassium Silicate; molar ratio = 3.9; 0.5 ml in deionized water	5 New Zealand White rabbits; sex not reported	Dermal irritation study in accordance with OECD Test Guideline 404; test material applied to shaved test site and occluded for 4 h before being rinsed; test site examined for up to 7 d	Not irritating; slight erythema cleared by 24 h ;PDII = 0.25	9,14
33% (weight) Potassium Silicate; molar ratio = 3.0; 0.5ml in water	1 male New Zealand White rabbit	Dermal irritation study in accordance with OECD Test Guideline 404; test material applied to shaved test site and semi-occluded for 4 h before being rinsed off with water; test site examined for up to 5 d	Moderately irritating; well-defined erythema and very slight edema persisted for at least 5 d; PDII =3	9,14
35% (weight) Potassium Silicate; molar ratio = 3.4; 0.5ml in deionized water	3 New Zealand White rabbits; sex not reported	Dermal irritation study in accordance with OECD Test Guideline 404; test material applied to shaved test site and occluded for 4 h before being rinsed; test site examined for up to 7 d	Not irritating; slight erythema after 1 h that cleared after 48 h; PDII = 0.17	9,14
36% (weight) Potassium Silicate; molar ratio = 2.0; 0.5ml in water	1 female New Zealand White rabbit	Dermal irritation study in accordance with OECD Test Guideline 404; test material applied to shaved test site and semi-occluded for 4 h before being rinsed off with water; test site examined for up to 5 d	Slightly irritating; transient erythema observed cleared by day 5; primary dermal irritation index (PDII) = 1	9,14
10% aq. Sodium Metasilicate; 0.5 ml in water	3 rabbits; strain and sex not reported	Dermal irritation study in accordance with OECD Test Guideline 404; test material applied to shaved test site and semi-occluded for 4 h before being rinsed; test site examined for up to 72 h	Slightly irritating; severity of erythema reduced but persisted through day 2; edema in 1 animal reversed by day 2; PDII = 1.22	10
50% aq. Sodium Metasilicate; 0.5 ml in water	3 rabbits; strain and sex not reported	Dermal irritation study in accordance with OECD Test Guideline 404; test material applied to shaved test site and semi-occluded for 4 h before being rinsed; test site examined for up to 72 h	Irritating; PDII = 3.67	10
57.5% (weight) Sodium Metasilicate (pentahydrate); 0.5 g	3 white landrace rabbits; sex not reported	Dermal irritation study in accordance with OECD Test Guideline 404; test material applied to shaved test site and semi-occluded for 4 h before being rinsed; test site examined for up to 14 d	Corrosive; 2/3 animals had acute skin necrosis and the 3 rd had pigmented necrosis; wounds persisted for more than 14 d; PDII = 7.8	10
83% (w/w) Sodium Metasilicate as aqueous paste; pH 12.4; 0.5 g/0.10 purified water; 0.3 ml applied	3 male New Zealand hybrid rabbits	Dermal irritation study in accordance with OECD Test Guideline 404; test material applied to shaved test site and semi-occluded for 4 h before being rinsed; test site examined for up to 14 d	Corrosive; erythema persisted for at least 14 d; edema observed 1 h post-treatment but cleared by 72 h; necrosis persisted 7-14+ d; PDII = 4.67	10
97% (weight) Sodium Metasilicate (anhydrous); 0.5 g	3 white landrace rabbits; sex not reported	Dermal irritation study in accordance with OECD Test Guideline 404; test material applied to shaved test site and semi-occluded for 4 h before being rinsed; test site examined for up to 14 d	Corrosive; 2/3 animals had acute skin necrosis with well-defined edema; wounds persisted for more than 14 d; third animal had wounds that were observed at up to 72 h but had healed by day 14;PDII = 5.1	10

Table 8. Dermal irritation and sensitization

Ingredient/Concentration/ Dose/Vehicle	Test System	Method	Results	Reference
Sodium Metasilicate (anhydrous); 0.5 g in water	1 male New Zealand White rabbits	Dermal irritation study in accordance with OECD Test Guideline 404; test material applied to shaved test site and semi-occluded for 4 h before being rinsed; test site examined for up to 5 d	Corrosive; necrosis observed; PDII = 8; no erythema or edema observed when applied as dry powder	10
Sodium Metasilicate (pentahydrate); 0.5 g in water	1 female New Zealand White rabbits	Dermal irritation study in accordance with OECD Test Guideline 404; test material applied to shaved test site and semi-occluded for 4 h before being rinsed; test site examined for up to 5 d	Corrosive; necrosis observed; PDII = 8; no erythema or edema observed when applied as dry powder	10
Sodium Metasilicate; concentration not reported; fine powder with pH of 12.4 tested undiluted; 0.5 g	3 New Zealand White rabbits; sex not reported	Dermal irritation study in accordance with OECD Test Guideline 404; test material applied to shaved test site and semi-occluded for 4 h before being rinsed; test site examined for up to 14 d	Not irritating; 1/3 animals had erythema and edema 1 h post-treatment that cleared by 72 h; PDII = 0.17	10
Sensitization – Animal				
0%, 5%, 10%, or 25% (w/v) Aluminum Silicate in dimethyl sulfoxide; application volume = 25 µl	4 female CBA/CaOlaHsd mice/dose group	Local lymph node assay (LLNA)	Not sensitizing; stimulation indices (SI) below 3	12
30% Potassium Silicate solution; molar ratio = 2.47	20 male Hartley guinea pigs received test material; 10 animals served as control	Buehler sensitization test; animals were induced with undiluted test material and challenged at 75%	Not sensitizing	9
0%, 10%, 25%, or 50% Zinc Silicate in acetone/olive oil (4:1; v/v)	6 female NMRI mice/dose group	LLNA	Not sensitizing; SI below 1.4; irritant response noted	7

Table 9. Ocular irritation

Ingredient/Concentration/ Dose/Vehicle	Test System	Method	Results	Reference
In Vitro				
Aluminum Silicate tested pure; no vehicle; 164.3 mg	Lohmann Leghorn chicken eggs	HET-CAM method; treatment duration = 5 min	Not irritating	12
Sodium Metasilicate; undiluted; 50 mg	New Zealand White rabbit eyes	Isolated rabbit eye study; treatment duration = 0.17 min; eyes studied for opacity for up to 4 h post-treatment	Corrosive	10
Zinc Silicate; 20% suspension in 750 µl of physiological saline solution (0.9% NaCl)	Bovine corneas	Bovine corneal opacity and permeability test (BCOP); exposure was 4 h	Irritating; mean opacity score of 3 corneas was 6.31; mean fluorescein retention/leakage score was < 0.01	7
Animal				
25% dilution of 29% (weight) Potassium Silicate; molar ratio = 3.9; 0.1 ml in deionized water	6 New Zealand White rabbits; sex not reported	Ocular irritation study in accordance with OECD Test Guideline 405; eyes not rinsed; observed for up to 7 d post-treatment	Not irritating	9,14
25% dilution of 35% (weight) Potassium Silicate; molar ratio = 3.4; 0.1 ml in water	3 New Zealand White rabbits; sex not reported	Ocular irritation study in accordance with OECD Test Guideline 405; eyes not rinsed; observed for up to 7 d post-treatment	Not irritating	9,14
29% (weight) Potassium Silicate; molar ratio = 3.9; 0.1 ml in water	6 New Zealand White rabbits; sex not reported	Ocular irritation study in accordance with OECD Test Guideline 405; eyes not rinsed; observed for up to 7 d post-treatment	Not irritating	9,14
~30% Potassium Silicate in water; molar ratio = 2.47; 0.1 ml	3 New Zealand White rabbits; sex not reported	Ocular irritation study; eyes not rinsed; observed for up to 7 d post-treatment	Slightly irritating	9
35% (weight) Potassium Silicate; molar ratio = 3.4; 0.1 ml in water	3 New Zealand White rabbits; sex not reported	Ocular irritation study in accordance with OECD Test Guideline 405; eyes not rinsed; observed for up to 7 d post-treatment	Slightly irritating; redness and chemosis of the conjunctivae (scores 1.0-1.3 and 1.3-1.5, respectively) observed up to 7 d post-treatment	9,14

REFERENCES

1. Andersen F, (ed),. Final Report on the Safety Assessment of Aluminum Silicate, Calcium Silicate, Magnesium Aluminum Silicate, Magnesium Silicate, Magnesium Trisilicate, Sodium Magnesium Silicate, Zirconium Silicate, Attapulgite, Bentonite, Fuller's Earth, Hectorite, Kaolin, Lithium Magnesium Silicate, Lithium Magnesium Sodium Silicate, Montmorillonite, Pyrophyllite, and Zeolite. *Int J Toxicol.* 2003;22(Suppl 1):37-102.
2. Andersen FA, (ed). Final Report on the Safety Assessment of Potassium Silicate, Sodium Metasilicate, and Sodium Silicate. *Int J Toxicol.* 2005;24(Suppl 1):103-117.
3. Becker L, Bergfeld W, Belsito D, et al. Safety Assessment of Silica and Related Cosmetic Ingredients. Washington, DC. 2009. Available from the Cosmetic Ingredient Review.: <https://www.cir-safety.org/ingredients>.
4. Nikitakis J, Kowcz A. Web-Based International Cosmetic Ingredient Dictionary and Handbook. <http://webdictionary.personalcarecouncil.org/jsp/Home.jsp>. Washington, DC: Personal Care Products Council. Last Updated 2020. Accessed 08/19/2020.
5. Burnett CL, Bergfeld WF, Belsito DV, et al. Amended Safety Assessment of Synthetically-Manufactured Amorphous Silica and Hydrated Silica as Used in Cosmetics. Washington, DC. 2019. Available from the Cosmetic Ingredient Review.: <https://www.cir-safety.org/ingredients>.
6. Becker L, Bergfeld W, Belsito D, et al. Safety Assessment of Silylates and Surface-Modified Siloxysilicates. *Int J Toxicol.* 2013;32(Suppl 1):5S-24S.
7. European Chemicals Agency. Dizinc Orthosilicate. <http://echa.europa.eu/>. Last Updated 3/23/2018. Accessed 5/14/2018.
8. European Chemicals Agency. Silicic Acid, Aluminum Magnesium Sodium Salt. <https://echa.europa.eu>. Last Updated 2/4/2018. Accessed 5/16/2018.
9. European Chemicals Agency. Silicic Acid, Potassium Salt. <https://echa.europa.eu>. Last Updated 4/13/2018. Accessed 5/16/2018.
10. European Chemicals Agency. Disodium Metasilicate. <https://echa.europa.eu>. Last Updated 5/18/2018. Accessed 5/18/2018.
11. European Chemicals Agency. Silicic Acid, Sodium Salt. <https://echa.europa.eu>. Last Updated 5/10/2018. Accessed 5/18/2018.
12. European Chemicals Agency. Aluminatesilicate. <https://echa.europa.eu>. Last Updated 5/10/2018. Accessed 5/21/2018.
13. European Chemicals Agency. Silicic Acid, Calcium Salt. <https://echa.europa.eu>. Last Updated 5/1/2018. Accessed 5/21/2018.
14. Organisation for Economic Co-Operation and Development Screening Information Data Sets (OECD SIDS). Soluble Silicates. 2004. <http://www.inchem.org/documents/sids/sids/solublesilicates.pdf>. Accessed 5/16/2018.
15. Synthetic Amorphous Silica and Silicate Industry Association (SASSI). 2019. Comments from the Synthetic Amorphous Silica and Silicate Industry Association to Cosmetic Ingredient Review Dr. Bart Heldreth (Director) and the Expert Panel on Post Meeting Announcement for Cosmetic Ingredient Review Expert Panel 151st Meeting (June 6-7, 2019) Findings June 12, 2019 and Amended Safety Assessment of Silica and Synthetically-Manufactured Silicated as Used in Cosmetics: June 19, 2019 Tentative Amended Report for Public Comment. Unpublished data submitted by SASSI on August 15, 2019.
16. U.S. Pharmacopeial Convention. *Food Chemicals Codex*. 8th ed. Baltimore, MD: United Book Press, Inc.; 2012.
17. Anonymous. 2020. Magnesium Aluminum Silicate: Origin and composition and impurities. Unpublished data submitted by the Personal Care Products Council on October 15, 2020.

18. Mizusawa Industrial Chemicals Ltd. 2020. Product Information Inonite (Sodium Magnesium Silicate). Unpublished data submitted by the Personal Care Products Council on November 5, 2020.
19. Anonymous. 2019. Product information: Sodium Silver Aluminum Silicate. Unpublished data submitted by the Personal Care Products Council on August 2, 2019.
20. Anonymous. 2020. Statement regarding crystallinity of Aluminum Calcium Sodium Silicate. Unpublished data submitted by the Personal Care Products Council on October 15, 2020.
21. Anonymous. 2020. Aluminum Calcium Sodium Silicate. Unpublished data submitted by the Personal Care Products Council on October 26, 2020.
22. Joint Food and Agriculture Organization of the United Nations (FAO)/World Health Organization (WHO) Expert Committee on Food Additives (JECFA). Calcium Silicate. Geneva. 2015.
23. Joint Food and Agriculture Organization of the United Nations (FAO)/World Health Organization (WHO) Expert Committee on Food Additives (JECFA). Magnesium Silicate, synthetic. Geneva. 2011.
24. Anonymous. 2020. Sodium Silver Aluminum Silicate: Crystallinity. Unpublished data submitted by the Personal Care Products Council on November 13, 2020.
25. U.S. Food and Drug Administration Center for Food Safety & Applied Nutrition (CFSAN). Voluntary Cosmetic Registration Program - Frequency of Use of Cosmetic Ingredients. College Park, MD. 2021. Obtained under the Freedom of Information Act from CFSAN; requested as "Frequency of Use Data" January 4, 2021; received January 21, 2021.
26. Personal Care Products Council. 2018. Council Concentration of Use Survey: Silica Ingredients. Unpublished data submitted by Personal Care Products Council on October 26, 2018.
27. Personal Care Products Council. 2018. Updated concentration of Use by FDA Product Category: Silicates. Unpublished data submitted by Personal Care Products Council on June 11, 2018.
28. Rothe H, Fautz R, Gerber E, et al. Special aspects of cosmetic spray safety evaluations: Principles on inhalation risk assessment. *Toxicol Lett.* 2011;205(2):97-104.
29. Rothe H. Special Aspects of Cosmetic Spray Evaluation. Unpublished data presented at the 26 September CIR Expert Panel meeting. Washington, D.C.
30. Bremmer H, Prud'homme de Lodder L, Engelen J. Cosmetics Fact Sheet: To assess the risks for the consumer; Updated version for ConsExpo 4. Bilthoven, Netherlands 2006 2006. RIVM 320104001/2006. Pages 1-77. <http://www.rivm.nl/bibliotheek/rapporten/320104001.pdf>. Accessed 8/24/2011.
31. Johnsen M. The Influence of Particle Size. *Spray Technology and Marketing.* 2004;14(11):24-27.
32. CIR Science and Support Committee of the Personal Care Products Council (CIR SSC). 11/3/2015 2015. Cosmetic Powder Exposure. Unpublished data submitted by the Personal Care Products Council.
33. Aylott R, Byrne G, Middleton J, Roberts M. Normal use levels of respirable cosmetic talc: Preliminary study. *Int J Cosmet Sci.* 1976;1(3):177-186.
34. Russell R, Merz R, Sherman W, Siverston J. The determination of respirable particles in talcum powder. *Food Cosmet Toxicol.* 1979;17(2):117-122.
35. Regulation (EC) No. 1223/2009 of the European Parliament and of the Council of 30 November 2009 on Cosmetic Products., (2009).
36. Australian Government Department of Health. Australian Industrial Chemicals Introduction Scheme (AICIS). <https://www.industrialchemicals.gov.au/chemical-information>. Last Updated Accessed 5/1/2018.

37. Colvin B, Sangster L, Haydon K, Beaver R, Wilson D. Effect of a high affinity aluminosilicate solvent on prevention of aflatoxicosis in growing pigs. *Vet Hum Toxicol*. 1989;31(1):46-48.
38. Kubena L, Harvey R, Bailey R, Buckley S, Rottinghaus G. Effects of hydrated sodium calcium aluminosilicate (T-Bind™) on mycotoxicosis in young broiler chickens. *Poult Sci*. 1998;77(10):1502-1509.
39. Kubena L, Hugg W, Harvey R, et al. Effects of a hydrated sodium calcium aluminosilicate on growing turkey poult during aflatoxicosis. *Poultry Sci*. 1991;70(8):1823-1830.
40. Chestnut A, Andersen M, Cochran H, Fribourg H, Gwinn K. Effects of hydrated sodium calcium aluminosilicate on fescue toxicosis and mineral absorption. *J Anim Sci*. 1992;70(9):2838-2846.
41. Harvey R, Kubena L, Elissalde M, Corrier D, Phillips T. Comparison of two hydrated sodium calcium aluminosilicate compounds to experimentally protect growing barrows from aflatoxicosis. *J Vet Diagn Invest*. 1994;6(1):88-92.
42. Smith E, Phillips T, Ellis J, et al. Dietary hydrated sodium calcium aluminosilicate reduction of aflatoxin M₁ residue in dairy goat milk and effects of milk production and components. *J Anim Sci*. 1994;72(3):677-682.
43. Abo-Norag M, Edrington T, Kubena L, Harvey R, Phillips T. Influence of a hydrated sodium calcium aluminosilicate and virginiamycin on aflatoxicosis in broiler chicks. *Poultry Sci*. 1995;74(4):626-632.
44. Sarr A, Mayura K, Kubena L, Harvey R, Phillips T. Effects of phyllosilicate clay on the metabolic profile of aflatoxin B₁ in Fischer-344 rats. *Toxicol Lett*. 1995;75(1-3):145-151.
45. Edrington T, Sarr A, Kubena L, Harvey R, Phillips T. Hydrated sodium calcium aluminosilicate (HSCAS), acidic HSCAS, and activated charcoal reduce urinary excretion of aflatoxin M₁ in turkey poults. Lack of effect by activated charcoal on aflatoxicosis. *Toxicol Lett*. 1996;89(2):115-122.
46. Abdel-Wahhab M, Nada S, Farag I, Abbas N, Amra H. Potential protective effect of HSCAS and bentonite against dietary aflatoxicosis in rat: With special reference to chromosomal aberrations. *Nat Toxins*. 1998;6(5):211-218.
47. Ledoux D, Rottinghaus G, Bermudez A, Alonso-Debolt M. Efficacy of a hydrated sodium calcium aluminosilicate to ameliorate the toxic effects of aflatoxin in broiler chicks. *Poult Sci*. 1999;78(2):204-210.
48. Sehu A, Ergün L, Cakir S, et al. Hydrated sodium calcium aluminosilicate for reduction of aflatoxin in quails (*Coturnix coturnix japonica*). *Dtsch Tierarztl Wochenschr*. 2007;114(7):252-259.
49. Jung S, Sielker S, Hanisch M, Libricht V, Schäfer E, Dammaschke T. Cytotoxic effects of four different root canal sealers on human osteoblasts. *PLoS ONE*. 2018;13(3):e0194467.
50. Ko H, Jeong Y, Kim M. Cytotoxicities and genotoxicities of cements based on calcium silicate and of dental formocresol. *Mutat Res*. 2017;815:28-34.
51. Raghavendra S, Jadhav G, Gathani K, Kotadia P. Bioceramics in endodontics - A review. *J Istanbul Univ Fac Dent*. 2017;51(3 Suppl 1):S128-S137.
52. Lewis R, Sr. *Hawley's Condensed Chemical Dictionary*. 15th ed. Hoboken, NJ: John Wiley & Sons, Inc.; 2007.
53. O'Neil M, (ed). *The Merck Index*. 15th ed: The Royal Society of Chemistry; 2013.
54. Sauer F, Laughland D, Davidson W. Silica metabolism in guinea pigs. *Can J Biochem Physiol*. 1959;37(2):183-191.
55. Sauer F, Laughland D, Davidson W. The silica content of guinea pig tissues as determined by chemical and isotopic techniques. *Can J Biochem Physiol*. 1959;37(10):1173-1181.
56. Abbès S, Ben Salah-Abbès J, Ouanes Z, et al. Preventive role of phyllosilicate clay on the immunological and biochemical toxicity of zearaleonone in Balb/c mice. *Internat Innumopharmacol*. 2006;6(8):1251-1258.
57. Abbès S, Ouanes Z, Ben Salah-Abbès J, et al. The protective effect of hydrated sodium calcium aluminosilicate against haematological, biochemical and pathological changes induced by Zearalenone in mice. *Toxicol*. 2006;47(5):567-574.

58. Rathnamali B, Samarajiwa G, Abeyratne D, Perera G, Gunatilake S. Acute kidney injury following ingestion of plate developer (sodium metasilicate): A case report. *BMC Res Notes*. 2016;9(1):412.
59. Hannu T, Riihimäki V, Piirilä P. Reactive airways dysfunction syndrome from acute inhalation of dishwasher detergent powder. *Can Respir J*. 2012;19(3):e25-e28.
60. Agency for Toxic Substances and Disease Registry (ATSDR). Toxicological Profile for Silica. 2019. <https://www.atsdr.cdc.gov/toxprofiles/tp211.pdf>. Accessed 01/29/2021.
61. Occupational Safety and Health Administration (OSHA). OSHA Factsheet: OSHA's Respirable Crystalline Silica Standard for General Industry and Maritime. US Department of Labor. <https://www.osha.gov/Publications/OSHA3682.pdf>. 2018. Accessed: 02/01/2021.
62. U. S. Department of Labor. Silica, Amorphous, Precipitated and Gel. https://www.osha.gov/dts/chemicalsampling/data/CH_266700.html. Last Updated 2018. Accessed 6/1/2018.
63. National Institute for Occupational Safety and Health (NIOSH). NIOSH Pocket Guide to Chemical Hazards. US Department of Health and Human Resources. <https://www.cdc.gov/niosh/npg/default.html>. 2019. Accessed: 02/01/2021.
64. Office of Environmental Health Hazard Assessment (California) (OEHHA). Determination of Noncancer Chronic Reference Exposure Levels Chronic Toxicity Summary 0 Silica (Crystalline, Respirable). <https://oehha.ca.gov/media/downloads/air/document/silicacrelfinal.pdf>. 2005. Accessed: 01/29/2021.

Final Report on the Safety Assessment of Aluminum Silicate, Calcium Silicate, Magnesium Aluminum Silicate, Magnesium Silicate, Magnesium Trisilicate, Sodium Magnesium Silicate, Zirconium Silicate, Attapulgite, Bentonite, Fuller's Earth, Hectorite, Kaolin, Lithium Magnesium Silicate, Lithium Magnesium Sodium Silicate, Montmorillonite, Pyrophyllite, and Zeolite¹

This report reviews the safety of Aluminum, Calcium, Lithium Magnesium, Lithium Magnesium Sodium, Magnesium Aluminum, Magnesium, Sodium Magnesium, and Zirconium Silicates, Magnesium Trisilicate, Attapulgite, Bentonite, Fuller's Earth, Hectorite, Kaolin, Montmorillonite, Pyrophyllite, and Zeolite as used in cosmetic formulations. The common aspect of all these claylike ingredients is that they contain silicon, oxygen, and one or more metals. Many silicates occur naturally and are mined; yet others are produced synthetically. Typical cosmetic uses of silicates include abrasive, opacifying agent, viscosity-increasing agent, anticaking agent, emulsion stabilizer, binder, and suspending agent. Clay silicates (silicates containing water in their structure) primarily function as adsorbents, opacifiers, and viscosity-increasing agents. Pyrophyllite is also used as a colorant. The International Agency for Research on Cancer has ruled Attapulgite fibers $>5 \mu\text{m}$ as possibly carcinogenic to humans, but fibers $<5 \mu\text{m}$ were not classified as to their carcinogenicity to humans. Likewise, Clinoptilolite, Phillipsite, Mordenite, Nonfibrous Japanese Zeolite, and synthetic Zeolites were not classified as to their carcinogenicity to humans. These ingredients are not significantly toxic in oral acute or short-term oral or parenteral toxicity studies in animals. Inhalation toxicity, however, is readily demonstrated in animals. Particle size, fibrogenicity, concentration, and mineral composition had the greatest effect on toxicity. Larger particle size and longer and wider fibers cause more adverse effects. Magnesium Aluminum Silicate was a weak primary skin irritant in rabbits and had no cumulative skin irritation in guinea pigs. No gross effects were reported in any of these studies. Sodium Magnesium Silicate had no primary skin irritation in rabbits and had no cumulative skin irritation in guinea pigs. Hectorite was nonirritating to the skin of rabbits in a Draize primary skin irritation study. Magnesium Aluminum Silicate and Sodium Magnesium Silicate

caused minimal eye irritation in a Draize eye irritation test. Bentonite caused severe iritis after injection into the anterior chamber of the eyes of rabbits and when injected intralaminally, widespread corneal infiltrates and retrocorneal membranes were recorded. In a primary eye irritation study in rabbits, Hectorite was moderately irritating without washing and practically nonirritating to the eye with a washout. Rats tolerated a single dose of Zeolite A without any adverse reaction in the eye. Calcium Silicate had no discernible effect on nidation or on maternal or fetal survival in rabbits. Magnesium Aluminum Silicate had neither a teratogenic nor adverse effects on the mouse fetus. Female rats receiving a 20% Kaolin diet exhibited maternal anemia but no significant reduction in birth weight of the pups was recorded. Type A Zeolite produced no adverse effects on the dam, embryo, or fetus in either rats or rabbits at any dose level. Clinoptilolite had no effect on female rat reproductive performance. These ingredients were not genotoxic in the Ames bacterial test system. In primary hepatocyte cultures, the addition of Attapulgite had no significant unscheduled DNA synthesis. Attapulgite did cause significant increases in unscheduled DNA synthesis in rat pleural mesothelial cells, but no significant increase in sister chromosome exchanges were seen. Zeolite particles ($<10 \mu\text{m}$) produced statistically significant increase in the percentage of aberrant metaphases in human peripheral blood lymphocytes and cells collected by peritoneal lavage from exposed mice. Topical application of Magnesium Aluminum Silicate to human skin daily for 1 week produced no adverse effects. Occupational exposure to mineral dusts has been studied extensively. Fibrosis and pneumoconiosis have been documented in workers involved in the mining and processing of Aluminum Silicate, Calcium Silicate, Zirconium Silicate, Fuller's Earth, Kaolin, Montmorillonite, Pyrophyllite, and Zeolite. The Cosmetic Ingredient Review (CIR) Expert Panel concluded that the extensive pulmonary damage in humans was the result of direct occupational inhalation of the dusts and noted that lesions seen in animals were affected by particle size, fiber length, and concentration. The Panel considers that most of the formulations are not respirable and of the preparations that are respirable, the concentration of the ingredient is very low. Even so, the Panel considered that any spray containing these solids should be formulated to minimize their inhalation. With this admonition to the cosmetics industry, the CIR Expert Panel concluded that these ingredients are safe as currently used in cosmetic formulations.

Received 4 December 2002; accepted 18 March 2003.

¹Reviewed by the Cosmetic Ingredient Review Expert Panel. This report was prepared by Amy R. Elmore, former Scientific Analyst and Writer. Address correspondence to F. Alan Andersen, Cosmetic Ingredient Review Director, 1101 17th Street, NW, Suite 310, Washington, DC 20036, USA.

The Panel did note that the cosmetic ingredient, Talc, is a hydrated magnesium silicate. Because it has a unique crystalline structure that differs from ingredients addressed in this safety assessment, Talc is not included in this report.

INTRODUCTION

Various silicates and silicate clays are used in cosmetics, largely for their adsorbent, anticaking, bulking, and other similar properties. They are created synthetically in some cases, e.g., Lithium Magnesium Silicate, or are refined from naturally occurring minerals, e.g., Magnesium Aluminum Silicate. In either case, variations in composition occur. Thus the Zeolite group of hydrated aluminosilicates has forms that are crystalline or fibrous, and contain interchangeable cations.

This report reviews the safety of these ingredients. Because the issues of safety are likely to be similar, many ingredients have been grouped. Although there are not data on each and every ingredient, it is expected that the data will be broadly applicable among the following ingredients: Aluminum Silicate (CAS no. 1327-36-2); Calcium Silicate (CAS no. 1344-95-2); Magnesium Aluminum Silicate (CAS no. 12199-37-0, 1327-43-1, 12511-31-8); Magnesium Silicate (CAS no. 1343-88-0); Magnesium Trisilicate (CAS no. 14987-04-3); Sodium Magnesium Silicate; Zirconium Silicate (CAS no. 14940-68-2); and the silicate clays/clay minerals: Attapulgite (CAS no. 1337-76-4, 12174-11-7); Bentonite (CAS no. 1302-78-9); Fuller's Earth (CAS No. 8031-18-3); Hectorite (CAS no. 12173-47-6); Kaolin (CAS no. 1332-58-7); Lithium Magnesium Silicate; Lithium Magnesium Sodium Silicate (CAS no. 53320-86-8); Montmorillonite (CAS no. 1318-93-0); Pyrophyllite (CAS no. 12269-78-2); and Zeolite (CAS no. 1318-02-1) used in cosmetics.

It is important to note that the cosmetic ingredient, Talc, is not included in this safety assessment. Talc is a hydrated magnesium silicate with the CAS no. 14807-96-6, but it should not be confused with any of the silicates in this report. Talc is differentiated by its definition, a hydrated magnesium silicate, and its unique crystalline form.

The safety of Quaternium-18 Hectorite and Quaternium-18 Bentonite have been previously reviewed by the Cosmetic Ingredient Review (CIR) Expert Panel; the final conclusion indicated that "Quaternium-18 Hectorite and Quaternium-18 Bentonite are safe as cosmetic ingredients in the present practices of use and concentration" (CIR 1980).

CHEMISTRY

Given the large number of ingredients, a tabular presentation of basic information concerning the chemical description has been provided (Table 1).

Zeolites

The Zeolite group is very diverse. Over 100 structural types of Zeolites, both natural and synthetic, have been reported, 40

of which are natural Zeolites (IARC 1997). Even though these Zeolites are considered to be a group, the formulas of the most common are listed in tabular form in Table 2 so the reader can understand the diversity in this category.

Physical and Chemical Properties

In alphabetical order according to the cosmetic ingredient name as specified in the *International Cosmetic Ingredient Dictionary and Handbook* (Wenninger et al. 2000), Table 3 provides information on the various synonyms used to describe each cosmetic ingredient, lists the available information on physical properties, and, if available, provides the specifications for the cosmetic grade of the ingredient.

Clay Structure

According to Grim (1967), clays in general have atomic lattices consisting of two structural units. One unit consists of two sheets of closely packed oxygens or hydroxyls as shown in Figure 1. Aluminum, iron, or magnesium atoms are embedded within these sheets in octahedral coordination, so that they are equidistant from the oxygen or hydroxyl groups.

The second unit is composed of silica tetrahedrons as shown in Figure 2. Assuming there are no distortions in each tetrahedron, a silicon atom is equidistant from four oxygens or hydroxyls, if needed to balance the structure, arranged in the form of a tetrahedron with a silicon atom in the center. The silica tetrahedral groups are arranged in a hexagonal network, which is repeated infinitely to form a sheet of composition $\text{Si}_4\text{O}_6(\text{OH})_4$. The tips of the tetrahedrons all point in the same direction and the bases are all in the same plane. Substantial distortion of these units occurs in order to fit into determined unit-cell dimensions of minerals (Grim 1967).

Attapulgite

The general attributes of structure and composition of the minerals are not very well known. The structurally important element is the amphibole double silica chain oriented with its long direction parallel to the *c* axis as shown in Figure 3. Attapulgite

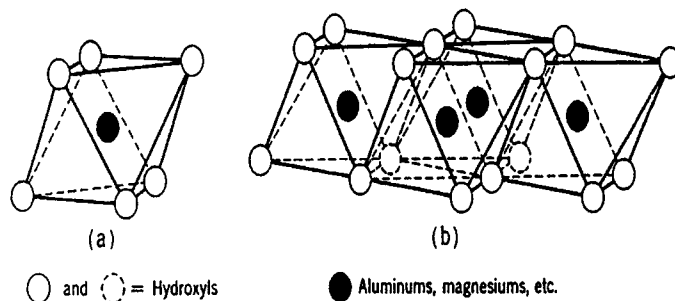

FIGURE 1

(a) Single octahedral unit; (b) Sheet of units (taken from Grim 1967 with permission).

TABLE 1
Chemical formulas and compositions of Silicates and Silicate Clays used in cosmetics

Ingredient	Description	Reference
Aluminum Silicate	$\text{Al}_2\text{O}_3 \cdot \text{SiO}_2$	Wenninger et al. 2000
	Complex inorganic salt that has a composition of consisting generally of 1 mole of alumina and 1 to 3 moles of silica	Wenninger et al. 2000
Calcium Silicate	Varying CaO and SiO_2	Wenninger et al. 2000
	Hydrous or anhydrous silicate with varying proportions of calcium oxide and silica	Wenninger et al. 2000
Magnesium Aluminum Silicate	$\text{Al}_2\text{MgO}_8\text{Si}_2$	Budavari 1989
	Complex silicate refined from naturally occurring minerals	Wenninger et al. 2000
Magnesium Silicate	$\text{MgO} \cdot \text{SiO}_2 \cdot x\text{H}_2\text{O}$	Wenninger et al. 2000
	Inorganic salt of variable composition	Wenninger et al. 2000
Magnesium Trisilicate	$2\text{MgO}_3 \cdot \text{SiO}_2 \cdot x\text{H}_2\text{O}$	Wenninger et al. 2000
	Inorganic compound	Wenninger et al. 2000
Zirconium Silicate	ZrSiO_4	Wenninger et al. 2000
	Inorganic compound	Wenninger et al. 2000
	Zircon sand or flour; specially sized grades of the mineral zircon—a naturally occurring zirconium silicate	American Minerals, Inc. 1998
Attapulgate	$[\text{Mg}(\text{Al}_{0.5-1}\text{Fe}_{0-0.5})\text{Si}_4\text{O}_{10}(\text{OH}) \cdot 4\text{H}_2\text{O}]$	IARC 1997
	Variety of Fuller's Earth (q.v.) found typically near Attapulgas, Georgia. It is characterized as having a chain structure rather than the usual sheet structure of other clays	Wenninger et al. 2000
	Hydrated magnesium aluminum silicate with magnesium partially replaced by aluminum, or to a lesser extent, iron	IARC 1997
Bentonite	Purified native magnesium aluminum silicate	Barr and Arnista 1957
	$\text{Al}_2\text{O}_3 \cdot 4\text{SiO} \cdot 2\text{H}_2\text{O}^a$ (empirical formula)	Informatics, Inc. 1974
	$\text{Na}_{0.33}[\text{Al}_{1.67}\text{Mg}_{0.33}]\text{Si}_4[\text{OH}]_2$	Rheox Inc. 1999
	Native hydrated colloidal aluminum silicate clay	Wenninger et al. 2000
Fuller's Earth	Commercial term for clays containing montmorillonite type minerals formed by the alteration of volcanic ash	Gamble 1986
	No specific formula	Wenninger et al. 2000
	Nonplastic variety of kaolin containing an aluminum magnesium silicate	Wenninger et al. 2000
Hectorite	Porous colloidal aluminum silicate, a catch-all phrase for clay or other fine-grained earthy material suitable for use as an absorbent and bleach	Gamble 1986
	$\text{Na}_{0.67}(\text{Mg},\text{Li})_6\text{Si}_8\text{O}_{20}(\text{OH},\text{F})_4^a$	Budavari 1989
	$\text{Na}_{0.33}[\text{Mg}_{2.67}\text{Li}_{0.33}]\text{Si}_4\text{O}_{10}[\text{OH}]_2$	Rheox Inc. 1999
	Montmorillonite mineral that is the principle constituent of bentonite clays	Wenninger et al. 2000
Kaolin/Kaolinite	Fluorine-bearing magnesium rich montmorillonite	Grim 1972
	Almost a complete substitution of aluminum in the lattice structure of bentonite by magnesium in hectorite and the presence of lithium and fluorine	United States Pharmacopeial Convention, Inc. 1994
	$\text{Al}_2\text{O}_3 \cdot 2\text{SiO}_2 \cdot 2\text{H}_2\text{O}$	Wenninger et al. 2000
Lithium Magnesium Silicate	Native hydrated aluminum silicate	Wenninger et al. 2000
	Kaolinite is the mineral that characterizes most Kaolins	Ross and Kerr 1931
	No specific formula	Wenninger et al. 2000
Lithium Magnesium Silicate	Synthetic clay consisting of mainly lithium and magnesium silicates	Wenninger et al. 2000

(Continued on next page)

TABLE 1
Chemical formulas and compositions of Silicates and Silicate Clays used in cosmetics (*Continued*)

Ingredient	Description	Reference
Lithium Magnesium Sodium Silicate	No specific formula Synthetic clay consisting mainly of lithium, magnesium, and sodium silicates	Wenninger et al. 2000 Wenninger et al. 2000
Montmorillonite	$R_{0.33}^+(Al,Mg)_2Si_4O_{10}(OH)_2$, where $R^+ = Na^+, K^+, Mg^{2+},$ or Ca^{2+} Complex aluminum/magnesium silicate clay Term used to describe a group of minerals with an expanding lattice, except vermiculite and also a specific mineral with a high-alumina end member of the montmorillonite group with some slight replacement of Al^{3+} by Mg^{++} and substantially no replacement of Si^{4+} by Al^{3+}	Budavari 1989 Wenninger et al. 2000 Grim 1972
Pyrophyllite	$Al_2O_3 \cdot 4SiO \cdot 2H_2O$ Naturally occurring mineral substance consisting predominantly of a hydrous aluminum silicate	Wenninger et al. 2000 Wenninger et al. 2000
Sodium Magnesium Silicate	No specific formula Synthetic silicate clay with a composition mainly of magnesium and sodium silicate	Wenninger et al. 2000 Wenninger et al. 2000
Zeolite	$M_{2/n}O \cdot Al_2O_3 \cdot ySiO_2 \cdot xH_2O$ ($M =$ a group IA or IIA element; $n =$ cation valence; $y = 2$ or greater; $x =$ the number of water molecules within the molecule) Hydrated alkali aluminum silicate Group of hydrated, crystalline aluminosilicates containing exchangeable cations of group IA and IIA elements such as sodium, potassium, magnesium, and calcium	IARC 1997 Wenninger et al. 2000 IARC 1997

TABLE 2
Zeolites (IARC 1997)

Zeolite	CAS no.	Chemical formula
Clinoptilolite (general)	12173-10-3	Not given
	12271-42-0	$Na(AlSi_5O_{12} \cdot xH_2O)$
	67240-23-7	$AlNaH_{16}(SiO_4 \cdot 4H_2O)$
Mordenite (general)	12173-98-7	Not given
	12445-20-4	$AlNaH_6(SiO_3)_5$
	66732-10-3	$Al_2CaH_{12}(SiO_3)_{10} \cdot H_2O$
	68652-75-5	$Na(AlSi_5O_{12})$
Phillipsite (general)	12174-18-4	Not given
	61027-84-7	$CaK[Al_3O(SiO_3)_5] \cdot 6H_2O$
	66733-09-3	$AlNa(SiO_4) \cdot 6H_2O$
Zeolite A	68989-22-0	$Na_{12}[(AlO_2)_{12}(SiO_2)_{12}] \cdot 27H_2O$
Zeolite X	68989-23-1	$Na_{86}[(AlO_2)_{86}(SiO_2)_{106}] \cdot 264H_2O$
Zeolite Y	Not specified	$Na_{56}[(AlO_2)_{56}(SiO_2)_{136}] \cdot 250H_2O$
Zeolite L	Not specified	$K_9[(AlO_2)_9(SiO_2)_{27}] \cdot 22H_2O$
ZSM-5	79982-98-2	$(NaTPA)_3[(AlO_2)_3(SiO_2)_{93}] \cdot 16H_2O^*$

*TPA = tetrapropylammonium.

consists of double silica chains situated parallel to the c axis with the chains linked together through oxygens at their longitudinal edges. Tetrahedral apexes in successive chains point in the opposite direction. The linked chains form a kind of double-ribbed sheet with two rows of tetrahedral apexes at alternate intervals in the top and bottom of the sheets. The ribbed sheets are arranged so that the apex oxygens of successive sheets point together and are held together by aluminum and/or magnesium in octahedral coordination between the apex oxygens of successive sheets. Chains of water molecules run parallel to the c axis and fill the interstices between the amphibole chains. Aluminum substitutions for silicon is considered probable (Grim 1967).

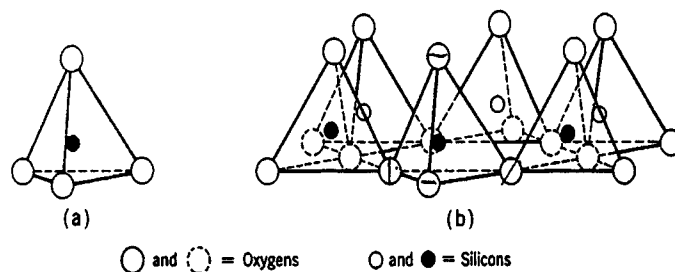

FIGURE 2

(a) Single tetrahedral unit; (b) Sheet of units (taken from Grim 1967 with permission).

TABLE 3
Synonyms for, physical properties of, and specifications for Silicates and Silicate Clays used in cosmetics

Item	Description	Reference
Aluminum Silicate		
Synonyms	Anhydrous aluminum silicate, china clay, natural aluminum silicate, pyrophyllite, synthetic aluminum silicate, willinite	Wenninger et al. 2000
Form/description	Kaolin	Budavari 1989
	Aluminosilicate	Syracuse Research Corp. 1974
Molecular weight	Generally consisting of 1 mole of alumina and 1 to 3 moles of silica	Wenninger et al. 2000
	Four naturally occurring minerals (andalusite, cyanite, sillimainte, mullite); other associated minerals: anauxite, dickite, kaolinite, kochite, newtonite, pyrophyllite, takizolite, termierite, and ton	Budavari 1989
Density	Variable: ranging from 162.05 to 426.05 Da	Lide 1993
Solubility	Variable: 3.156, 3.247	Lide 1993
	Insoluble in water	Syracuse Research Corp. 1974
Calcium Silicate		
Synonyms	Silicic acid, calcium salt	Wenninger et al. 2000
Form/description	Hydrous or anhydrous silicate with varying proportions of calcium oxide and silica	Wenninger et al. 2000
	White or slightly cream colored free-flowing powder	Budavari 1989
Molecular weight	116.16 Da	Lide 1993
Solubility	Insoluble in water	Budavari 1989
pH	8.0–10.0 (aqueous slurry)	Budavari 1989
Magnesium Aluminum Silicate		
Synonyms	Aluminum magnesium silicate, magnesium aluminosilicate, complex colloidal, <i>Carrisorb</i> , <i>Gelsorb</i> , <i>VEEGUM</i>	Palmieri 1994
Form/description	Aluminosilicic acid, magnesium salt, aluminum magnesium silicate	Wenninger et al. 2000
	Complex silicate refined from naturally occurring minerals	Wenninger et al. 2000
Molecular weight	Off-white to creamy white small flakes or micronized powder	Palmieri 1994
	262.4 Da	Budavari 1989
Solubility	Insoluble in water, alcohol, and organic solvents	Palmieri 1994
pH	9.0–10.0 (5% aqueous solution)	Nikitakis and McEwen 1990b
Viscosity	225–2200 mPa	Palmieri 1994
CTFA specifications	Arsenic (as As), 3 ppm maximum	Nikitakis and McEwen 1990a
	Lead (as Pb), 10 ppm maximum	Nikitakis and McEwen 1990a
Magnesium Silicate		
Synonyms	Silicic acid, magnesium salt (1:1)	Wenninger et al. 2000
Form/description	Fine, white, odorless, tasteless, powder, free from grittiness	United States Pharmacopeial Convention, Inc. 1994
		United States Pharmacopeial Convention, Inc. 1994
Solubility	Insoluble in water and alcohol	United States Pharmacopeial Convention, Inc. 1994
CTFA specifications	Arsenic (as As), 3 ppm maximum	Nikitakis and McEwen 1990a
	Lead (as Pb), 20 ppm maximum	Nikitakis and McEwen 1990a
Magnesium Trisilicate		
Synonyms	Silicic acid, magnesium salt (1:2)	Wenninger et al. 2000
Form/description	Fine, white, odorless, tasteless powder, free form grittiness	United States Pharmacopeial Convention, Inc. 1994
		United States Pharmacopeial Convention, Inc. 1994
Solubility	Insoluble in water and alcohol	United States Pharmacopeial Convention, Inc. 1994
Sodium Magnesium Silicate		
Synonyms	Synthetic sodium magnesium silicate	Wenninger et al. 2000
Form/description	Synthetic silicate clay with a composition mainly of magnesium and sodium silicate	Wenninger et al. 2000

(Continued on next page)

TABLE 3
Synonyms for, physical properties of, and specifications for Silicates and Silicate Clays used in cosmetics (*Continued*)

Item	Description	Reference
Zirconium Silicate		
Synonyms	Silicic acid, zirconium salt (1:1) Zircon, zirconium orthosilicate Zirconium (IV) silicate (1:1)	Wenninger et al. 2000 Budavari 1989 Lewis 1993
Form/description	Bipyramidal crystals, colorless unless has impurities and radioactive bombardment Red or various colored crystals	Budavari 1989 Lewis 1993
Molecular weight	183.31 Da	Budavari 1989
Solubility	Insoluble in alcohol, aqueous solution, and alkali	Lide 1993
Density	4.56	Lide 1993
pH	6–7.5 (10% aqueous slurry)	American Minerals 1998
CTFA specifications	Arsenic (as As), 3 ppm maximum Lead (as Pb), 20 ppm maximum	Nikitakis and McEwen 1990a Nikitakis and McEwen 1990a
Attapulgate		
Synonyms	Activated attapulgate, Attaclay, Attagel, Attasorb, Min-u-gel, palygorskit, Permigel, Zeogel	Registry of Toxic Effects of Chemical Substances (RTECS) 1999
Form/description	Palygorskite Variety of Fuller's Earth; characterized by a chain structure rather than the sheet structure of other clay minerals White, gray, or transparent, dull, elongated, lath-shaped crystals in bundles that comprise thin sheets of minute interlaced fibers; surface is protonated and hydrated	IARC 1997 Wenninger et al. 2000 IARC 1997
Density	2.2	IARC 1997
Solubility	Insoluble in water	United States Pharmacopeial Convention, Inc. 1994
Bentonite		
Synonyms	CI 77004, soap clay Albagen Premium USP 4444, Bentonite magma, Hi-gel, Imvite I.G.B.A., Magbond, montmorillonite, Tixoton, Volclay, Wilkinito BentoPharm, E558, mineral soap, soap clay, taylorite, Veegum HS, wilkinito	Wenninger et al. 2000 RTECS 1999 Belmonte 1994
Form/description	Native hydrated colloidal aluminum silicate clay Crystalline, claylike material, available as an odorless, palebuff or cream to grayish-colored fine powder, which is free from grit Dioctahedral	Wenninger et al. 2000 Belmonte 1994 Rheox Inc. 1999
Molecular weight	359.16 Da	Belmonte 1994
Solubility	Practically insoluble in ethanol, fixed oils, glycerin, propan-2-ol and water	Belmonte 1994
pH	9.5–10.5 for a 2% aqueous solution	Belmonte 1994
Particle size	Mainly 50–150 μm along with 1–2 μm particles 0.8 \times 0.8 \times 0.01 μ	Belmonte 1994 Rheox Inc. 1999
Color	Grey to green	Rheox Inc. 1999
Swelling ability	15 \times	Rheox Inc. 1999
Iron	2.3%	Rheox Inc. 1999
Fuller's Earth		
Synonyms	English Fuller's earth	Wenninger et al. 2000
Form/description	Nonplastic variety of kaolin Sheet structure	Wenninger et al. 2000 Gamble 1986

(Continued on next page)

TABLE 3

Synonyms for, physical properties of, and specifications for Silicates and Silicate Clays used in cosmetics (*Continued*)

Item	Description	Reference
Hectorite		
Synonyms	Macaloid, Ben-A-Gel Bentone and Bentone Gel	Barr 1963 Rheox Inc. 1999
Form/description	Translucent colorless mineral when mined and turns white when dried	Barr 1963
Particle size	Tridecahedral 0.8 × 0.08 × 0.01 μ	Rheox Inc. 1999 Rheox Inc. 1999
pH	8.5 (5% slurry)	Rheox Inc. 1999
Iron	0.2% (typical)	Rheox Inc. 1999
Color	Light pink to tan; off-white	Rheox Inc. 1999
Swelling ability	35×	Rheox Inc. 1999
Odor	None	Rheox Inc. 1999
Specific gravity	2.65	Rheox Inc. 1999
Kaolin		
Synonyms	Bolbus Alba, China Clay, CI 77004, Kolite, Pigment White 19 Altowhites, Argilla, Bentone, China Clay, Emathlite, Fitrol, Glomax, Hydrite, Kaopaous, Langford, Mcnamee, Parclay, Porcelain Clay, Snow tex	Wenninger et al. 2000 RTECS 1999
	Bolbus alba, China clay, white bole, argilla, terra alba, porcelain clay White or yellowish white, earthy mass or white powder; unctous when moist	Informatics, Inc. 1974 Budavari 1989
Form/description	Native hydrated aluminum silicate	Wenninger et al. 2000
Molecular weight	258.2 Da	Budavari 1989
Solubility	Insoluble in water, cold acids, or in alkali hydroxides	Budavari 1989
Cation exchange capacity	3–15 mEq/100 g	Carrol 1959
CTFA specifications	Arsenic (as As), 3 ppm maximum Lead (as Pb), 20 ppm maximum	Nikitakis and McEwen 1990a Nikitakis and McEwen 1990a
Lithium Magnesium Silicate		
Synonyms	Silicic acid, lithium magnesium salt	Wenninger et al. 2000
Form/description	Synthetic silicate clay consisting mainly of lithium and magnesium silicates	Wenninger et al. 2000
Lithium Magnesium Sodium Silicate		
Synonyms	Magnesium lithium sodium silicate; silicic acid, lithium, magnesium, and sodium salt	Wenninger et al. 2000
Form/description	Synthetic silicate clay consisting mainly of lithium, magnesium and sodium silicates	Wenninger et al. 2000
Montmorillonite		
Synonyms	Smectite	Grim 1972
Form/description	Complex aluminum/magnesium silicate clay	Wenninger et al. 2000
Cation exchange capacity	80–150 mEq/100 g	Carrol 1959
Pyrophyllite		
Synonyms	Pyrophyllite clay	Wenninger et al. 2000
Form/description	Naturally occurring mineral—predominantly hydrous aluminum silicate	Wenninger et al. 2000
Sodium Magnesium Silicate		
Synonyms	Synthetic sodium magnesium silicate	Wenninger et al. 2000
Form/description	Synthetic silicate clay with a composition mainly of sodium and magnesium silicate	Wenninger et al. 2000
pH	8.5–10.5 of 2% aqueous dispersion	Nikitakis and McEwen 1990b
Solubility	Insoluble in organic solvents and disperses in water	Nikitakis and McEwen 1990b

(Continued on next page)

TABLE 3
Synonyms for, physical properties of, and specifications for Silicates and Silicate Clays used in cosmetics (*Continued*)

Item	Description	Reference
	Zeolite	
Synonyms	Aluminosilicates, Bacterkiller, CS100, Sitton, Zeokar, Zeolith, Zeolum, Zeostar Clinoptilolite, Mordenite, Phillipsite, Zeolite A, Zeolite X, ZSM-5, Non-fibrous Japanese Zeolite	Wenninger et al. 2000 IARC 1997
Form/description	Crystalline, hydrated alkali-aluminum silicates	Budavari 1989; Wenninger et al. 2000

Kaolin

Kaolin's structure is composed of a single silica tetrahedral sheet and a single alumina octahedral sheet combined in a unit so that the tips of the silica tetrahedrons and one of the layers of the octahedral sheet form a common layer as shown in Figure 4. All the tips of the silica tetrahedrons point in the same direction and toward the center of the unit made by the silica and octahedral sheets. Composite octahedral-tetrahedral layers are formed due to the similarity between the sheets *a* and *b* dimensions. The common layer between the octahedral and tetrahedral groups consists of two thirds of shared atoms between silicon and aluminum that become O instead of OH. Analyses of Kaolin have

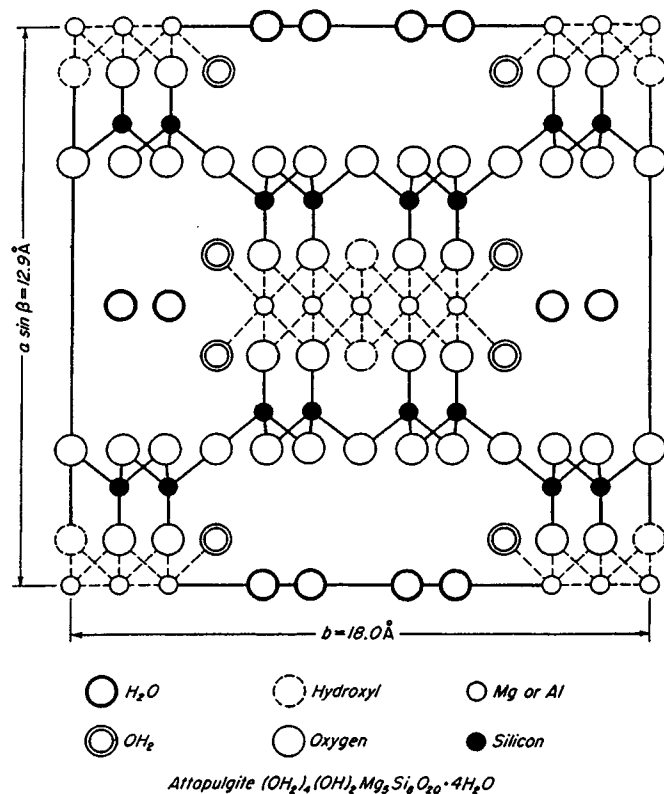

FIGURE 3

Attapulgite structure (taken from Grim 1967 with permission).

shown there is little substitution within the lattice. In a small percentage of cases, iron and/or titanium has replaced aluminum. This has only been seen in the relatively poor crystalline varieties of Kaolin (Grim 1967).

Smectites (*Montmorillonites, Hectorite, and Bentonite*)

Smectite units comprise of two silica tetrahedral sheets with a central alumina octahedral sheet as shown in Figure 5. All tetrahedral tips point in the same direction and toward the center of the unit. The tips of the tetrahedrons of each silica sheet and one of the hydroxyl layers of the octahedral sheet form a common layer. As in Kaolin, the atoms common to both the tetrahedral and octahedral layer become O instead of OH. These layers are continuous in the *a* and *b* directions and are stacked one above the other in the *c* direction. As a consequence, O layers in the units become adjacent and a very weak bond is created with the possibility of cleavage. The preeminent feature of smectites is the ability of water and other organic molecules to enter between unit layers and expand in the *c* direction. Expansion properties are reversible; however, the structure is completely collapsed by removal of interlayer polar molecules. Most smectites have substitutions within their lattices: aluminum or phosphorous for

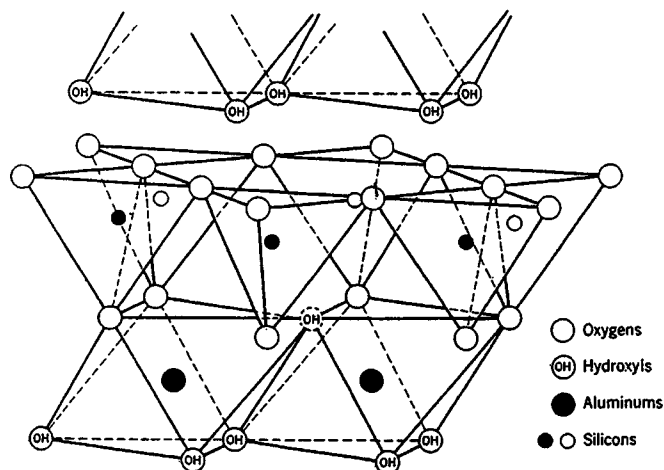

FIGURE 4

Kaolin layer (taken from Grim 1967 with permission).

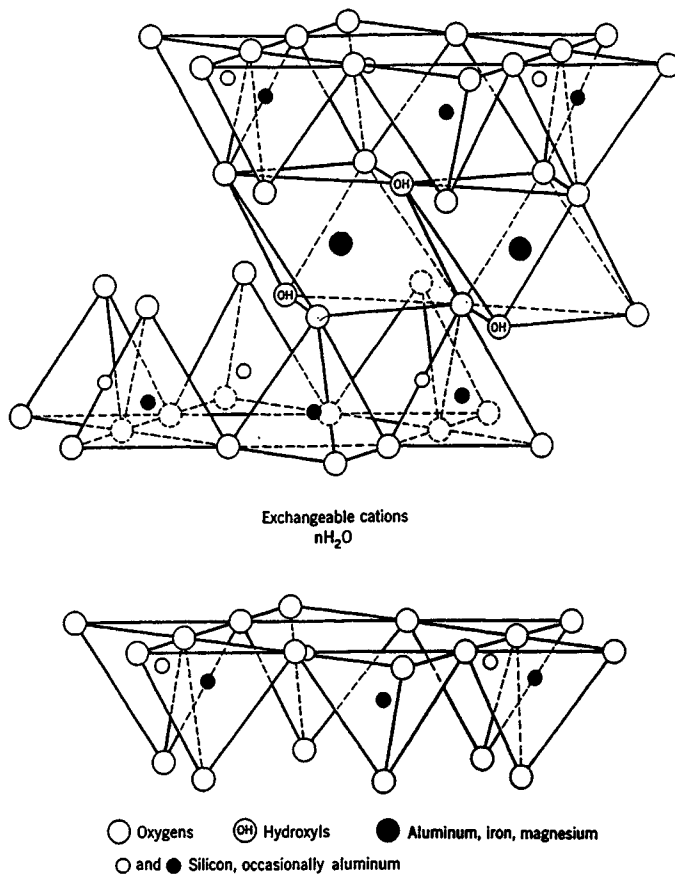

FIGURE 5

Smectite structure (taken from Grim 1967 with permission).

silicon in the tetrahedral coordination and/or magnesium, iron, zinc, nickel, lithium, etc. for aluminum in the octahedral sheet (Grim 1967).

Natural Occurrence of Clays

Aluminum Silicate

Natural Aluminum Silicates are reportedly being mined in India, California, North Carolina, and Georgia (Gamble 1986).

Attapulgit

Attapulgit is mined in 10 countries: Australia, China, France, India, Russia, Senegal, South Africa, Spain, Turkey, and the United States (Informatics, Inc. 1974).

Bentonite

Large deposits of Bentonite have been discovered in Canada, China, France, Germany, Great Britain, Greece, Hungary, Italy, Japan, Mexico, New Zealand, North Africa, Poland, South Africa, the former Soviet Union, and the United States (Informatics, Inc. 1974).

Kaolin

Deposits of Kaolin have been found in England, the United States, France, Czechoslovakia, Germany, and Japan (Informatics, Inc. 1974).

Pyrophyllite

Gamble (1986) reported Pyrophyllite being mined primarily in North Carolina.

Zeolite

Natural Zeolites are mined in Japan, the United States, Hungary, Bulgaria, Cuba, Italy, and South Africa (Roskill Informations Services Ltd. 1988).

Method of Manufacture

Aluminum Silicate

Aluminum Silicate is a naturally occurring mineral as well as artificially produced. The naturally occurring Aluminum Silicate minerals are know as andalusite, sillimanite, and cyanite. Natural Aluminum Silicate is mined from an ore and synthetic Aluminum Silicate is formed by heating compositions of controlled proportions of silica, alumina, and alkalis under conditions to promote the specific structure (Syracuse Research Corp. 1981).

Attapulgit

Hevilin and Murray (1994) describe the mining process of Attapulgit as an opencast technique, stripping layers with heavy machines such as bulldozers, backhoes, and excavators. The clay is then transported to a processing plant where crushing, drying, classification, and pulverizing takes place. High-heat drying to remove water may occur to enhance absorbent qualities.

Bentonite

The mined ore of Bentonite is processed to remove grit and nonswelling materials (Belmonte 1994).

Kaolin

In a process described by Wells, Bhatt, and Flanagan (1985), Kaolin is extracted from kaolinized granite by washing it out with powerful and remote water hoses. The clay stream is then pumped to the separation plant where sand and mica are removed. The purified clay is filtered when wet and then dried. The very fine powder is formed by milling.

Magnesium Aluminum Silicate

Magnesium Aluminum Silicate is obtained from silicate ores of the montmorillonite group. The ores are blended with water to produce a slurry, which is then processed to remove impurities and separate out the colloidal fractions. Refined colloidal fractions are dried to form a small flake and then is microatomized to form various powder grades (Palmieiri 1994).

Zeolite

Roskill Informations Services Ltd. (1988) reported natural Zeolites being recovered from deposits by selective opencast or strip mining processes. The raw material is then processed by crushing, drying, powdering, and screening. Synthetic Zeolite synthesis requires the following conditions: reactive starting materials; a high pH; a low-temperature hydrothermal state with concurrent low autogenous pressure at saturated water pressure; and a high degree of supersaturation of a large number of crystals.

Analytical Methods

Montmorillonite has been detected using far infrared spectra (Angino 1964). Bentonite and Kaolin are described by Angino (1964) using far infrared spectra and by Sadik (1971) using x-ray diffraction. Attapulgite has been detected with the use of transmission or scanning electron microscope (Zumwalde 1976), and by means of x-ray powder diffraction analysis (Keller 1979). The characterization of Hectorite was achieved through x-ray diffraction, infrared spectroscopy, and chemical analysis (Browne et al. 1980). Zeolites have been examined using scanning electron microscopy (Wright and Moatamed 1983; van Hoof and Roelofsen 1991) and x-ray diffraction (van Hoof et al. 1991). Magnetic angle spinning nuclear magnetic resonance (NMR) has confirmed the structural breakdown of Fuller's Earth (Drachman, Roch, and Smith, 1997).

IMPURITIES/COMPOSITION*Aluminum Silicate*

Other minerals associated with natural Aluminum Silicates are anauxite, dickite, kaolinite, kochite, mullite, newtonite, pyrophyllite, takizolite, terierite, and ton (Budavari 1989).

Attapulgite

Attapulgite commonly is found with smectites, amorphous silica, chert, and other minerals (Bish and Guthrie 1993).

A typical composition is shown in Table 4 (Keller 1979).

Bentonite

The principle constituent is Montmorillonite. However, other minerals such as illite, kaolinite, and nonargillaceous detrital minerals can be present. Most Bentonites appear relatively pure and other mineral contributions rarely exceed 10%. Cristobalite is often present. Montmorillonite compositions frequently vary either in its lattice structure or in the exchangeable ions present (Informatics, Inc. 1974).

A typical composition is shown in Table 4 (Belmonte 1994).

Fuller's Earth

Principle deposits of Fuller's Earth include Montmorillonite, Bentonite, Attapulgite, and sepiolite (Gamble 1986).

TABLE 4

Mineral composition of individual samples of Magnesium Aluminum Silicate, Attapulgite, Bentonite, Hectorite, Kaolinite, and Montmorrillonite (Barr 1963)

Mineral	Silicate clays analyzed					
	Magnesium Aluminum Silicate (%)	Attapulgite (%)	Bentonite (%)	Hectorite (%)	Kaolinite (%)	Montmorillonite (%)
SiO ₂	61.1	55.03	59.92	55.86	45.44	51.14
Al ₂ O ₃	9.3	10.24	19.78	0.13	38.52	19.76
Fe ₂ O ₃	—	3.53	—	0.03	0.80	0.83
FeO	0.9	—	2.96	—	—	—
MgO	13.7	10.49	1.53	25.03	0.08	3.22
CaO	2.7	—	0.64	Trace	0.08	1.62
K ₂ O	0.3	0.47	0.57	0.10	0.14	0.11
Na ₂ O	2.9	—	20.6	2.68	0.66	0.04
TiO ₂	0.1	—	—	—	0.16	—
CO ₂	1.8	—	—	—	—	—
LiO ₂	—	—	—	1.05	—	—
F	—	—	—	5.96	—	—
MnO	—	—	—	—	—	Trace
ZnO	—	—	—	—	—	0.10
H ₂ O	7.2	19.86	Not reported	12.14	14.20	22.80
Reference	Palmieri 1994	Keller 1979	Belmonte 1994	Keller 1979	Keller 1979	Keller 1979

Hectorite

Principle impurities include calcite, dolomite, silica crystals, and grit (Barr 1963). A typical composition is shown in Table 4 (Keller 1979).

Kaolin

Quartz, mica, and feldspar are often found associated with the crude mineral and is often removed through screening and elutriation (Informatics, Inc. 1974).

Ferreira and Freitas (1976) surveyed Kaolin for any potentially pathogenic organisms and a mean viable count. *Pseudomonas aeruginosa*, *Salmonella typhosa*, *Escherichia coli*, *Staphylococcus aureus*, and *Clostridium tetani* were absent. The mean viable count was $74 \times 10^3/6$ M. The bacteria present were mostly gram-positive aerobic spore-formers.

A typical composition is shown in Table 4 (Keller 1979).

Magnesium Aluminum Silicate

One trade-name group of products contain 1% to 6% by volume weight crystalline silica in the form of cristaballite; they also comment that a few grades may contain quartz as well (Kelse 1997).

A typical composition is shown in Table 4 (Palmeiri 1994).

Montmorillonite

A typical composition of Montmorillonite is shown in Table 4 (Keller 1979).

Zeolite

Valatina, Pylev, and Lemjasev (1994) analyzed the chemical compositions of five samples of Zeolite dusts taken from mines in Russia (Table 5). The benzo[a]pyrene content in the dusts of natural Zeolite tuffs (rock deposits) ranged from 0.0 to 3.6 $\mu\text{g}/\text{kg}$.

TABLE 5
Zeolite mine dust chemical analysis (Valatina, Pylev, and Lemjasev 1994)

Dust sample	1	2	3	4	5
Molar ratio of SiO ₂ /Al ₂ O ₃	9.0	8.3	9.8	7.4	9.4
Zeolite (%)	83	50.6	73	63	56
Silicon dioxide (%)	66.84	0	70.92	62.64	68.6
Aluminum oxide (%)	12.36	12.62	12.11	14.17	12.16
Iron (III) oxide (%)	0.92	4	1.03	2.65	0.2
Magnesium oxide (%)	1.53	1.34	0.53	1.19	0.93
Calcium oxide (%)	2.36	4.15	2.56	2.01	1.93
Sodium oxide (%)	2.65	0.15	0.62	1.75	2
Benzo[a]pyrene	2.5	3.6	0.1	1.3	0

USE

Cosmetic

According to the European Cosmetic Directive (EU reference no. 391 Annex II), Zirconium and its compounds are listed under substances that must not form part of the composition of cosmetic products, with the exception of complexes in Annex III, Part I. These complexes are aluminum zirconium chloride hydroxide complexes and the aluminum zirconium chloride hydroxide glycine products used in antiperspirants; and the zirconium lakes, salts, and pigments of coloring agents listed in reference 3 in Annex IV, Part I (Cosmetics Directive of the European Union 1995).

Aluminum Silicate, anhydrous, Calcium Silicate, Magnesium Aluminum Silicate, Magnesium Silicate, Bentonite, Hectorite, Kaolin, Montmorillonite, Pyrophyllite, and Zeolite are listed in the *Japanese Comprehensive Licensing Standards by Category (CLS)* (Rempe and Santucci 1998). Aluminum Silicate, anhydrous has no concentrations limits and is listed in all categories except eyeliner preparations and lip preparations. Calcium Silicate, is listed in all categories. Magnesium Aluminum Silicate, which is listed under Aluminum Magnesium Silicate, is listed in all categories. Magnesium Silicate is listed in all categories. Hectorite is listed in all categories except eyeliner preparations, lip preparations, and oral preparations. Montmorillonite is excluded from only eyeliner preparations. Pyrophyllite is listed in all groups except eyeliner, lip, oral, and bath preparations. Bentonite, Kaolin, and Zeolite are listed in all categories.

Information on use of ingredients in cosmetic formulations is available from the Food and Drug Administration (FDA) as part of a voluntary industry reporting program (FDA 1998). These data are presented in the first two columns of Table 6.

In addition, the Cosmetic, Toiletry, and Fragrance Association (CTFA) provides information from the industry directly to CIR on the current concentration of use (CTFA 1999a). In some cases a current concentration of use is provided even when there is no current use reported to FDA. It is presumed that an industry report of a current concentration of use means the ingredient is in use. These data are included in the third column of Table 6.

In those cases where there is a use reported to FDA, but there is no current concentration of use data available, the last column in Table 6 includes historical data from 1984 when FDA collected information on concentration as part of the voluntary reporting program described earlier (FDA 1984). If no historical data are available, no concentration is listed.

Aluminum Silicate

Aluminum Silicate functions as an abrasive, anticaking agent, bulking agent, and opacifying agent in cosmetics (Wenninger et al. 2000). In 1998 it was reported as an ingredient in 10 formulations in seven different categories (FDA 1998).

TABLE 6
Frequency of use and concentration of use as a function of product category

Product category (Number of formulations reported to FDA 1998)	Number of formulations containing ingredient (FDA 1998)	Current concentration of use (CTFA 1999a) (%)	Historical concentration of use (FDA 1984) (%)
Aluminum Silicate			
Mascara (167)	2	0.5	
Blushers (all types) (238)	1	—	—
Dentifrices (38)	—	37	
Shaving cream (139)	1	—	—
Cleansing (653)	2	2	
Paste masks (mud packs) (255)	1	—	1-5
Skin fresheners (184)	1	—	0.1-1
Other skin preparations (692)	2	3	
1998 total uses of Aluminum Silicate	10		
Calcium Silicate			
Bath oils, tablets, and salts (124)	12	—	0.1-5
Bubble baths (200)	2	—	0.1-25
Other bath preparations (159)	2	—	0.1-25
Eye shadow (506)	11	1-8	
Powders (247)	35	2	
Blushers (all types) (238)	17	5-8	
Face powders (250)	40	0.3-10	
Foundations (287)	5	2-8	
Lipstick (790)	3	0.5	
Makeup bases (132)	1	0.5	
Rouges (12)	1	—	1-5
Other makeup preparations (135)	1	—	1-5
Other manicuring preparations (61)	1	—	1-5
Skin cleansing preparations (653)	1	8	
Men/s talcum (8)	—	8	
1998 total for Calcium Silicate	132		
Magnesium Aluminum Silicate			
Other bath preparations (159)	1	—	—
Eye makeup remover (84)	20	—	0.1-25
Eye shadow (506)	4	1	
Eye lotion (18)	1	1	
Eye makeup remover (84)	2	—	0.1-25
Mascara (167)	33	0.4-5	
Eyeliners (514)	—	0.2-0.5	
Eyebrow pencil (91)	—	0.5	
Other eye makeup preparations (120)	16	1-5	
Cologne and toilet waters (656)	1	—	—
Other fragrance preparations (148)	1	—	>0-1
Hair conditioners (636)	1	—	0.1-1
Hair straighteners (63)	3	—	0.1-1
Hair dyes and colors (1572)	—	2	
Shampoos (noncoloring) (860)	3	1-2	
Other hair preparations (276)	3	—	—
Hair rinses (coloring) (33)	1	—	—
Foundations (287)	130	0.4-5	
Lipstick (790)	3	—	0.1-1
Makeup bases (132)	60	1-2	

(Continued on next page)

TABLE 6
Frequency of use and concentration of use as a function of product category (*Continued*)

Product category (Number of formulations reported to FDA 1998)	Number of formulations containing ingredient (FDA 1998)	Current concentration of use (CTFA 1999a) (%)	Historical concentration of use (FDA 1984) (%)
Makeup fixatives (11)	3	2	
Other makeup preparations (135)	24	0.8	
Cuticle softeners (19)	1	—	—
Nail creams and lotions (17)	1	—	0.1-5
Dentifrices	—	0.7	
Bath soaps and detergents (385)	1	0.5-1	
Deodorants (underarm) (250)	5	0.5-1	
Other personal cleanliness products (291)	14	2	
Aftershave lotion (216)	9	—	1->50
Other shaving preparations (60)	2	—	0.1-5
Skin cleansing preparations (653)	41	0.1-5	
Face and neck skin care preparations (263)	16	0.6-3	
Body and hand skin care preparations (796)	56	0.3-5	
Foot powders and sprays (35)	3	—	—
Moisturizers (769)	70	0.3-4	
Night creams, lotions, powders, and sprays (188)	11	0.3-2	
Paste masks (mud packs) (255)	34	3-5	
Other skin care preparations (692)	33	0.1	
Suntan gels, creams, and liquids (136)	6	2-5	
Indoor tanning preparations (62)	19	0.5-2	
1998 total for Magnesium Aluminum Silicate	632		
	Attapulгите		
Powders (fragrance) (247)	5	—	—
Body and hand skin care preparations (796)	—	8	
Paste masks (mud packs) (255)	5	8	
1998 total for Attapulгите	10		
	Bentonite		
Bath, oils, tablets, and salts (124)	—	5	
Eyeliners (514)	6	5	
Mascara (167)	1	0.8	
Other eye makeup preparations (120)	1	—	—
Hair conditioners (636)	1	—	—
Hair straighteners (63)	3	—	0.1-1
Foundations (287)	5	2-8	
Makeup bases (132)	3	1	
Cuticle softeners (19)	1	1	
Bath soaps and detergents (385)	1	0.5	
Other personal cleanliness products (291)	2	—	0.1-10
Skin cleansing preparations (653)	6	—	>0-10
Face and neck skin care preparations (excluding shaving) (263)	1	2-5	
Body and hand skin care preparations (excluding shaving) (796)	6	2-5	
Moisturizers (769)	2	3	
Night creams, lotions, powders, and sprays (188)	1	—	—
Paste masks (mud packs) (255)	44	12-80	
Skin fresheners (184)	1	—	—

(Continued on next page)

TABLE 6
Frequency of use and concentration of use as a function of product category (*Continued*)

Product category (Number of formulations reported to FDA 1998)	Number of formulations containing ingredient (FDA 1998)	Current concentration of use (CTFA 1999a) (%)	Historical concentration of use (FDA 1984) (%)
Other skin preparations (692)	8	—	—
Suntan gels, creams, and liquids (136)	1	—	—
Other suntan preparations (38)	—	1	—
1998 total for Bentonite	73		
	Fuller's Earth		
Paste masks (mud packs) (255)	2	—	—
Other skin preparations (692)	1	—	25–50
1998 total for Fuller's Earth	3		
	Hectorite		
Eyeliners (514)	3	—	—
Mascara (167)	1	0.7	—
Shampoos (noncoloring) (860)	—	1	—
Hair bleaches (113)	5	—	—
Foundations	—	15	—
Other makeup preparations (135)	1	—	1–5
Basecoats and undercoats (manicuring) (48)	1	—	—
Nail polish and enamel (80)	1	—	—
Deodorants (underarm) (250)	1	0.7	—
Other personal cleanliness products (291)	1	—	—
Paste masks (mud packs) (255)	2	0.4	—
Skin cleansing preparations (653)	—	100	—
Body and hand creams, lotions, powders, and sprays (796)	—	8	—
Other skin preparations (692)	1	—	—
Paste masks (mud packs) (255)	—	8	—
Other suntan preparations (38)	1	—	—
1998 total for Hectorite	18		
	Sodium Magnesium Silicate		
Eyeliners	—	0.08	—
Eye shadow (506)	11	0.08	—
Mascara (167)	1	0.4	—
Other eye makeup preparations (120)	1	—	—
Powders (fragrance) (247)	1	—	—
Tonics, dressings, and other hair-grooming aids (549)	1	—	—
Blushers (all types) (238)	2	—	—
Face powders (250)	3	0.4	—
Foundations (287)	4	0.4	—
Lipstick (790)	1	3	—
Makeup bases (132)	—	0.1	—
Other makeup preparations (135)	1	—	—
Dentifrices (38)	—	0.3	—
Deodorants (underarm) (250)	—	0.5	—
Skin cleansing preparations (653)	—	0.5	—
Face and neck skin care preparations (excluding shaving) (263)	3	0.8–5	—
Body and hand skin care preparations (excluding shaving) (796)	2	0.1	—
Moisturizers (769)	1	1	—

(Continued on next page)

TABLE 6
Frequency of use and concentration of use as a function of product category (*Continued*)

Product category (Number of formulations reported to FDA 1998)	Number of formulations containing ingredient (FDA 1998)	Current concentration of use (CTFA 1999a) (%)	Historical concentration of use (FDA 1984) (%)
Paste masks (mud packs) (255)	1	5	
Skin fresheners (184)	—	5	
Other skin preparations (692)	1	—	1–5
1998 total for Sodium Magnesium Silicate	34		
	Kaolin		
Other bath preparations (159)	1		1–10
Eyebrow pencil (91)	5	15–17	
Eyeliners (514)	9	25–48	
Eye shadow (506)	171	3–29	
Mascara (167)	31	8–18	
Other eye makeup preparations (120)	15	20	
Powders (247)	40	5	
Hair conditioners (636)	5	4	
Tonics, dressings, and other hair-grooming aids (549)	—	15	
Other hair-coloring preparations (59)	1	5	
Blushers (all types) (238)	72	14–20	
Face powders (250)	58	30	
Foundations (287)	45	6–36	
Lipstick (790)	6	12–30	
Makeup bases (132)	24	7–25	
Rouges (12)	2	—	>0–50
Makeup fixatives (11)	3	—	1–5
Paste masks (mud packs) (255)	—	12–84	
Other makeup preparations (135)	20	10–24	
Bath soaps and detergents (385)	1	3	
Other manicuring preparations (61)	—	53–54	
Skin cleansing preparations (653)	—	0.01	
Face and neck skin care preparations (263)	—	3	
Moisturizers (769)	—	25	
Skin fresheners (184)	—	2	
Other skin care preparations (692)	—	3–100	
Suntan gels, creams, liquids (136)	—	25	
1998 total for Kaolin	509		

Attapulgate

Attapulgate functions as an abrasive, bulking agent, opacifying agent, and viscosity-increasing agent (Wenninger et al. 2000). The FDA reported in 1998 Attapulgate being used in 10 formulations (FDA 1998).

Bentonite

Bentonite functions as an absorbent, bulking agent, emulsion stabilizer, opacifying agent, suspending agent—nonsurfactant, and viscosity-increasing agent—aqueous in cosmetic formulations (Wenninger et al. 2000). In 1998, 94 formulations were reported (FDA 1998). Of the 94 formulations, 47% were reported within paste masks (mud packs) (FDA 1998).

Calcium Silicate

Calcium Silicate functions as an absorbent, bulking agent, and an opacifying agent in cosmetic formulations (Wenninger et al. 2000). The FDA reported 132 formulations containing Calcium Silicate in 1998, of which 30% of the formulations were face powders (FDA 1998).

Fuller's Earth

Fuller's Earth functions as an absorbent, anticaking agent, bulking agent, and opacifying agent (Wenninger et al. 2000). Fuller's Earth was reported in three formulations in 1998 (FDA 1998).

Hectorite

Hectorite functions as an absorbent, bulking agent, opacifying agent, suspending agent—nonsurfactant, and viscosity-increasing agent—aqueous (Wenninger et al. 2000). In 1998, Hectorite was reported in 18 formulations (FDA 1998). Rheox Inc. (1999a) reported Hectorite as being used in antiperspirants, suntan products, eye products, hair products, creams and lotions, lip products, facial masks, and nail products.

Kaolin

Kaolin functions as an abrasive, absorbent, anticaking agent, bulking agent, and opacifying agent in cosmetic formulations (Wenninger et al. 2000). Of the 509 formulations reported by FDA in 1998, 34% were eye shadows (FDA 1998).

Lithium Magnesium Silicate

Lithium Magnesium Silicate functions as a binder, bulking agent, and viscosity-increasing agent—aqueous in cosmetic formulations (Wenninger et al. 2000). There were no current uses reported to FDA.

Lithium Magnesium Sodium Silicate

Lithium Magnesium Sodium Silicate functions as a bulking agent and viscosity-increasing agent—aqueous (Wenninger et al. 2000). There were no current uses reported to FDA.

Magnesium Aluminum Silicate

Magnesium Aluminum Silicate functions as an absorbent, anticaking agent, opacifying agent, and viscosity-increasing

agent—aqueous in cosmetics (Wenninger et al. 2000). It was reported that Magnesium Aluminum Silicate was used in 629 formulations in 1998 (FDA 1998). Of those 629 formulations, 21% were used in foundations.

Magnesium Aluminum Silicate (VEEGUM) was reported by Carlson (1977) to typically be used at a concentration of 1% to 2%, consistent with the data in Table 6. Another source reported Magnesium Aluminum Silicate used at concentrations of 10% to 50% for adsorbents, 0.5% to 2.5% for stabilizing agents, 1% to 10% for suspending agents, 2% to 10% for tablet and capsule disintegrants, 2% to 10% tablet binders, and 2% to 10% viscosity-increasing agents, again consistent with data in Table 6 (Palmieri 1994).

Additional historical data on concentration of use of this ingredient are available from a Toilet Good Association survey. Table 7 is a summary of that information (Toilet Goods Association 1969).

Magnesium Silicate

Magnesium Silicate functions as an absorbent, anticaking agent, bulking agent, opacifying agent, and viscosity-increasing agent—aqueous in cosmetic formulations (Wenninger et al. 2000). There were no current uses reported to FDA.

Magnesium Trisilicate

Magnesium Trisilicate functions as an abrasive, absorbent, anticaking agent, bulking agent, opacifying agent, and viscosity-increasing agent—aqueous in cosmetics (Wenninger et al. 2000).

TABLE 7
Magnesium Aluminum Silicate in cosmetic preparations (Toilet Goods Association 1969).

Product category	Use in product	Concentration (%)
Face cream/lotion (cleansing, hormone, night, acne, astringent)	Thickener, binder, emulsion stabilizer	2.1
Hand cream/lotion	Thickener, binder, emulsion stabilizer	1.3
Body cream/lotion (moisturizer, suntan preparations)	Thickener, binder, emulsion stabilizer, slip agent	1.6
Makeup (lotion, cream, medicated, matte, highlight)	Thickener, binder, emulsion stabilizer, pigment suspender	1.8
Rouge (cream, liquid, blusher, toner)	Thickener, binder, pigment suspender	1.8
Face mask	Thickener, binder	8.9
Powder aerosol	Anticaking	8.0
Powder compact/pressed	Oil absorption	1.0
Leg makeup	Thickener	3.9
Deodorant/antiperspirant	Thickener, emulsion stabilizer	1.8
Eye makeup (eyeshadow, mascara, eyeliner)	Thickener, emulsion stabilizer, pigment suspender	2.0
Depilatory	Thickener	2.0
Shave preparations	Thickener	0.5
Shampoo	Thickener	3.5
Cream sachet	Thickener, emulsion stabilizer	0.8

Montmorillonite

Montmorillonite functions as an abrasive, absorbent, emulsion stabilizer, opacifying agent, and viscosity-increasing agent—aqueous in cosmetics (Wenninger et al. 2000). There were no current uses reported to FDA.

Pyrophyllite

Pyrophyllite functions as an absorbent, colorant, and opacifying agent (Wenninger et al. 2000). There were no current uses reported to FDA.

Sodium Magnesium Silicate

Sodium Magnesium Silicate functions as binder and bulking agent (Wenninger et al. 2000). In 1998, Sodium Magnesium Silicate was reported in 34 formulations (FDA 1998).

Zeolite

Zeolite functions as an absorbent and deodorant agent in cosmetic formulations (Wenninger et al. 2000). There were no current uses reported to FDA.

Zirconium Silicate

Zirconium Silicate functions as an abrasive and opacifying agent in cosmetic formulations (Wenninger et al. 2000). There were no current uses reported to FDA.

Noncosmetic

Aluminum Silicate

Aluminum Silicate is approved, under the heading of indirect food additives, as a substance used as basic components of single or repeated use of the food contact surfaces cellophane (21 Code of Federal Regulations [CFR] 177.1200) and rubber (21 CFR 177.2600).

Attapulgate

Attapulgate is listed in the OTC Active Ingredient Status Report as proposed category I, as an antidiarrheal ingredient (FDA 1994). Attapulgate is listed by Gamble (1986) as being primarily used in absorbents, pesticides, oil and petroleum treatment, and as a filler in many products.

Bentonite

Bentonite is considered by FDA to be generally recognized as safe (GRAS) as a direct food additive (21 CFR 184.1155).

Bentonite is listed by Gamble (1986) as being used in foundry sand bonding, bleaching clay in oil refining and decolorizers, filtering agents, water impedance, animal feed, pharmaceuticals, paint, plasticity increasers, and iron-ore pelletizing. Another source reported Bentonite as being used as an adsorbent, emulsion stabilizer, and suspending agent (Belmonte 1994). Bentonite is categorized by the *National Formulary* as a suspending and/or viscosity-increasing agent (United States Pharmacopeial Convention, Inc. 1994).

Calcium Silicate

Calcium Silicate is listed in the OTC Active Ingredient Status Report as an external analgesic and skin protectant (FDA 1994). The *National Formulary* category is as a glident and/or anticaking agent (United States Pharmacopeial Convention, Inc. 1994).

The American Conference of Governmental Industrial Hygienists (ACGIH) TLV-TWA (threshold limit value–time weighted average) is 10 mg/m³ for inhalable dust (ACGIH 1997).

Hectorite

Hectorite has two listings of category IISE in the OTC Active Ingredient Status Report (FDA 1994). It is listed as being used as an external analgesic and skin protectant. Barr (1957) stated that the Federal Drug Administration (sic) has given approval for the use of Hectorite in internally and externally applied products, as well as dentifrices, cosmetics, and externally approved pharmaceuticals.

Kaolin

According to FDA, Kaolin is considered GRAS as an indirect food additive (21 CFR 186.1256). Kaolin is listed as being used in antacids, anorectals (external and interrectal), antidiarrheals, skin protectants, and digestive aids (colloidal Kaolin) in the OTC Active Ingredient Status Report. The final rulings are as follows: antacids: category IIE; anorectals (both): category I; and digestive aid: category IISE. Proposed rulings are as follows: antidiarrheal: category IIIE; skin protectant diaper rash: category I; skin protectant poison ivy: category I; and skin protectant: category I. Category III is designated as the conditions for which the available data are insufficient to permit final classification at this time.

Gamble (1986) reports Kaolin's main use in the paper industry to fill and coat the surface of paper. Kaolin is also reported being used as a filler in rubber, paint extender, filler in plastics, ceramics manufacture, ink, adhesives, insecticides, medicines, food additives, bleaching, adsorbents, cement, fertilizers, crayons, pencils, detergents, porcelain enamels, paste, foundries, linoleum, floor tiles, and textiles.

The *National Formulary* classifies Kaolin as a tablet and/or capsule diluent (United States Pharmacopeial Convention, Inc. 1994).

The *Food Chemicals Codex* specifies limits of impurities for clay (Kaolin) as: acid-soluble substances <2%; Arsenic (as As) <3 ppm; Heavy Metals (as Pb) <40 ppm; Lead <10 ppm (National Academy of Science 1996).

Magnesium Aluminum Silicate

Magnesium Aluminum Silicate (MAS) is listed as being used in acne treatments and in antacids in the OTC Active Ingredient Status Report (FDA 1994). As an antacid, MAS is a category I listing, meaning it is generally recognized as safe and effective and is not misbranded. However, MAS is a category IISE listing as used for acne. MAS was listed as category IISE due to safety and/or effectiveness.

Other uses for Magnesium Aluminum Silicate have been reported as: adsorbent, suspending agents, tablet and capsule disintegrant, tablet binder, and viscosity-increasing agent (Palmieri 1994).

The *National Formulary* classifies Magnesium Aluminum Silicate as a suspending and/or viscosity-increasing agent (United States Pharmacopeial Convention, Inc. 1994).

VEEGUM, a tradename for Magnesium Aluminum Silicate, has been designated by the FDA as a raw material with the following number: FD-CRMCS no. R0010045 and has an individual Chemical Abstract Registry (CAS) number 12199-37-0.

Magnesium Silicate

Magnesium Silicate is classified as a glidant or anticaking agent by the *National Formulary* (United States Pharmacopeial Convention, Inc. 1994).

Magnesium Trisilicate

Magnesium Trisilicate is listed in the OTC Active Ingredient Status Report as being used as antacids, digestive aids, and overindulgence remedy (FDA 1994). In antacids, FDA has listed Magnesium Trisilicate as category I (generally recognized as safe and effective). FDA concluded that Magnesium Trisilicate use in digestive aids is category II SE (not generally recognized as safe and effective). FDA has proposed that Magnesium Trisilicate use in overindulgence remedies is category I.

Pyrophyllite

Pyrophyllite is listed under Code of Federal Regulations (21 CFR 73.1400) as a naturally occurring color additive and must conform to the following specifications: lead (as Pb) not more than 20 ppm; and arsenic (as As) not more than 3 ppm. Also Pyrophyllite may be used safely for coloring externally applied cosmetics, in amounts consistent with good manufacturing practice (21 CFR 73.2400).

Pyrophyllite is listed by Gamble (1986) as being used in refineries, rubber, ceramics, insecticides, plastics, paint, roofing, bleaching powder, textiles, cordage, and wall board.

Zeolite

Zeolites are reported by Gamble (1986) as being used in CO₂ recovery from natural gas, aromatic separates dimension stones, filler in paper, isolation of radioactive wastes, water aeration, dietary supplements for animals, neutralization of acidic soils, carriers for pesticides and fungicides, sorbents for oil spills, polishing agent in toothpastes, and petroleum solvents. International Agency for Research on Cancer (IARC) (1997) lists the three main uses of synthetic Zeolite as: detergents, catalysts, and adsorbents or desiccants.

Zirconium Silicate

Zirconium Silicate is reported by Kleber and Putt (1986) as being used in chewing gum and in a dental prophylaxis paste.

GENERAL BIOLOGY

Adsorption

The large volume of general data available on the adsorption of various chemicals, cells, etc., to these silicate clays is presented in Table 8. In addition, to this general information, specific reactions are described using specific silicate clays—these data are described below.

Hectorite

Bujdak and Rode (1996) reported that Hectorite-catalyzed glycine and diglycine oligomerizations were performed as drying/wetting cycles. Approximately 7% of glycine was converted to diglycine and diketopiperazine on Hectorite after 7 days. It may be noted that the Hectorite sample was altered by substituting Li(I) for Mg(II), which caused a greater effect on oligomerizations.

Porter et al. (1998) reported condensation reactions of the amino acid glycine on the surface of Cu(II)-exchanged Hectorite. Polymerization of glycine oligomers was seen primarily at the edges or topmost layer. These reactions were facilitated by the availability of intergallery metal cations at the step edges or pores in the surface region.

Kaolin

Adenosine monophosphate molecules were adsorbed onto Kaolinite, modified with Mg²⁺ and irradiated with ultraviolet (UV) light. These synthesis products were tested for their bond types by enzymatic hydrolysis and analyzed by ion-exchange chromatography. Considerable portions of the products were phosphodiesterase hydrolyzed, which implies a 3'-5', 2'-5', or both, nature of the bonds (Strigunkova, Lavrentiev, and Ostroshchenko 1986).

Montmorillonite

Dougherty et al. (1985) incubated Montmorillonite saturated with magnesium chloride (10 mg) with 5×10^6 human neutrophils. Effects were determined by phase contrast microscopic examination and by the measurement of lactate dehydrogenase. Both untreated and clay treated with human albumin were used to stimulate neutrophil chemiluminescence. Montmorillonite was also incubated with human erythrocytes and the free hemoglobin was measured at 430 nm and the effect of clay on zymosan-activated serum was also investigated. Rapid neutrophil lysis was observed in cells exposed to untreated clay. After lysis, lactate dehydrogenase rapidly adsorbed to the surface of the clay. Clay pretreatment with human albumin blocked the enzyme surface adsorption and cell lysis. Neutrophil chemiluminescence was stimulated by untreated clay but not by clay pretreated with 5% albumin. Clay lysis of erythrocytes was incomplete as compared to neutrophil lysis. Zymosan-activated serum samples exposed to clay; complement activity as measured by neutrophil chemotaxis was suppressed in a dose-dependent manner.

TABLE 8
Adsorption of various chemicals, cells, etc., to Silicate clays

Compound adsorbed	Experimental design	Results	Reference
Magnesium Aluminum Silicate			
Dicumarol	The drug dicumarol was given to dogs with 50% colloidal Magnesium Aluminum Silicate (MAS); the plasma level of dicumarol in dogs was measured	Significantly lower plasma levels and delayed appearance of dicumarol resulted from administration with 50% MAS; drug concentration at peak level was 16.7% (25.8% in controls) and peak plasma levels were seen at 12–24 h (8–12 h in controls)	Akers, Lach, and Fischer 1973
Streptomycin sulphate and neomycin sulphate	Adsorption studies were carried out in vitro in McIlvaine's Buffer and water	MAS had the greatest affinity for streptomycin sulphate in water (adsorption coefficient of $111 \cdot 10^{-3}$ for water and $33 \cdot 10^{-3}$) whereas the adsorption coefficient for MAS in water to neomycin sulphate was $34 \cdot 10^{-3}$	Ghazy, Kassem, and Shalaby 1984
Bromohexine HCL	MAS was mixed with bromohexine HCL to make tablets and were stored in polyethylene film for various times; the amount of bromohexine remaining in the tablet was determined	Bromohexine remaining in the tablets increased with increasing concentrations of MAS, indicating that MAS prevented the adsorption of bromohexine to polyethylene film; no bromohexine degradation was reported	Kukita et al. 1992
Tetracycline	In vitro and in vivo adsorption of tetracycline by VEEGUM was studied	The maximum serum concentration of tetracycline was decreased by 21%; the maximum adsorption in vitro occurred at pH 1.2, where the % adsorbed ranged from 91.5% to 97.2%	Healy et al. 1997
Trimethoprim	The concentration of trimethoprim in the blood was determined at 0, 15, and 30 min and 1, 2, 4, and 6 h	The mean decrease in the maximum blood concentration of trimethoprim was 49.94%	Babhair and Tariq 1983
Aminosidine sulphate, chloramphenicol, erythromycin, neomycin B sulphate, novobiocin sulphate, penicillin V, streptomycin sulphate, and tetracycline hydrochloride	Each antibiotic was added to 250 mg of magnesium trisilicate; the antibiotic activity was determined by cup-plate method using <i>Staphylococcus aureus</i>	Magnesium Trisilicate reduced the activity of all antibiotics except chloramphenicol	El-Nakeeb and Youssef 1968
Ampicillin and amoxicillin	In vitro adsorption and desorption studies were carried out at different pHs	Hydrated silica gel formed from decomposition of the antacid at pH 2.1 and Magnesium Trisilicate had no adsorptive effect on either antibiotic	Khali, Mortada, and El-Khawas 1984a
Attapulgit			
Strychnine, quinine, and atropine	Adsorption isotherms for each of the drugs and the clay was determined using spectrophotometric or colorimetric methods	Attapulgit adsorbed strychnine better than atropine than quinine; an increase in the hydrogen ion concentration was found to have a slight decreasing effect on the adsorptive ability for strychnine	Evcim and Barr 1955

(Continued on next page)

TABLE 8
Adsorption of various chemicals, cells, etc., to Silicate clays (*Continued*)

Compound adsorbed	Experimental design	Results	Reference
Strychnine and atropine	Activated attapulgite was added to both compounds and adsorption isotherms were calculated	Both compounds were adsorbed by Attapulgite; optimum adsorbent properties were calculated at pH 6.8 and 7.2	Barr and Arnista 1957
<i>Agrobacterium radiobacter</i>	The measurement of O ₂ uptake by calculating the respiration quotients (Q _{O₂}) was performed on all species of bacteria in the presence of 2% Kaolin with either adjusted (7.0) or unadjusted pHs	Attapulgite contained excess basic cations, which accounted for the initial high pH and the reduction on respiration elicited by the addition of buffer	Stotzky 1966
<i>Vibrio cholerae</i> and <i>Escherichia coli</i> enterotoxins	The toxins and Attapulgite were injected into the intestinal loop of rabbits	Attapulgite prevented the toxic effects caused by enterotoxins in the intestinal loop by adsorption; Attapulgite was effective when injected simultaneously with the toxin and before the toxin is injected	Drucker et al. 1977
Ampicillin and amoxycillin	In vitro adsorption and desorption studies were carried out at different pHs	Both drugs were adsorbed at pH 2.1; desorption experiments at pH values of 2.0 and 6.5 showed only partial release of the adsorbed antibiotics	Khali, Mortada, and El-Khawass 1984a
Bentonite			
<i>Escherichia coli</i> , <i>Serratia marcescens</i> , and <i>Bacillus</i> species	Each organism was cultivated in broth portions with 3% and 10% Bentonite	All organisms were absorbed by Bentonite at each concentration; <i>Bacillus</i> species was almost completely absorbed at each concentration	Novakova 1977
<i>Escherichia coli</i> 0111 endotoxins (ETU 144, 150, and 153)	In vitro and in vivo endotoxin binding was studied	In vitro, Bentonite was an effective endotoxin binder and binding was pH dependent (lower pHs yielded better results); 75 mg completely eliminated endotoxemia. At pH 3.0, the ED ₅₀ was 20 mg	Ditter, Urbaschek, and Urbascek 1985
Zearalenone and nivalenol	20 or 50 g/kg of Bentonite was added to the feed of pigs contaminated with zearalenone and nivalenol and was ingested for 29 days	Bentonite was unsuccessful at overcoming the estrogenic or depressed performance effects caused by the mycotoxins	Williams, Blaney, and Peters 1994
Aflatoxins B ₁ , B ₂ , G ₁ , G ₂ , M ₁	Various methods	2% Bentonite adsorbed 400 μg of B ₁ ; 2% adsorbed 89% of M ₁ ; 2.5% adsorbed 5 ppm of B ₁ and G ₁ and 0.5 to 5 ppm of B ₂ and G ₂ ; 10% adsorbed 70% B ₁	Ramos, Fink-Gremmels, and Hernandez 1996
Kaolin			
Strychnine and atropine	Kaolin was added to both compounds and adsorption isotherms were calculated	Both compounds were adsorbed by Kaolin	Barr and Arnista 1957

(Continued on next page)

TABLE 8
Adsorption of various chemicals, cells, etc., to Silicate clays (*Continued*)

Compound adsorbed	Experimental design	Results	Reference
Aminosidine sulphate, chloramphenicol, erythromycin, neomycin B sulphate, novobiocin sulphate, penicillin V, streptomycin sulphate, and tetracycline hydrochloride	Each antibiotic was added to 250 mg of Kaolin; the antibiotic activity was determined by cup-plate method using <i>Staphylococcus aureus</i>	Kaolin adsorbed significant amounts of aminosidine, neomycin, streptomycin, and tetracycline; Kaolin had no effect on antibiotic activity	El-Nakeeb and Youssef 1968
<i>Agrobacterium radiobacter</i>	The measurement of O ₂ uptake by calculating the respiration quotients (Q_{O_2}) was performed on all species of bacteria in the presence of 2% Kaolin with either adjusted (7.0) or unadjusted pHs	Kaolin did not maintain the pH therefore the bacteria could not maintain respiration even with an optimal pH for growth	Stotzky 1966
<i>Bacillus subtilis</i> , <i>Bacillus megaterium</i> , <i>Aerobacter aerogenes</i> , <i>Escherichia intermedia</i> , <i>Pseudomonas aeruginosa</i> and <i>P. aeruginosa</i> C-II, <i>Flavobacterium</i> species, <i>Proteus vulgaris</i>	The measurement of O ₂ uptake by calculating the respiration quotients (Q_{O_2}) was performed on all species of bacteria in the presence of 2% Kaolin with either adjusted (7.0) or unadjusted pHs	Kaolin in unadjusted pH systems reduced respiration of the bacteria below that of cultures without clay; but in adjusted systems some stimulation of respiration with the addition of Kaolin was apparent	Stotzky and Rem 1966
Mycelial homogenates of 27 species of fungi	Fungal mycelium and Kaolinite were cultured together and the O ₂ uptake and pH were recorded	Kaolinite concentrations <4% generally did not effect respiration; respiration was only markedly inhibited at concentrations >40%	Stotzky and Rem 1967
Crystal violet	2 g of Kaolin was added to 100 ml of a crystal violet solution	Adsorption was examined over a pH range of 2.5–9.5; adsorption increased with increasing pH	Armstrong and Clarke 1971
<i>Staphylococcus aureus</i>	Suspension of the organism, Kaolinite, and NaCl were studied	Increasing electrolyte concentration was accompanied by increased edge-to-face Kaolinite flocculation and organism-Kaolin aggregates	Steel and Anderson 1972
<i>Escherichia coli</i>	<i>E. coli</i> was cultivated in broth portions with 3% and 10% Kaolinite	<i>E. coli</i> was absorbed by Kaolin at both concentrations; the greatest adsorption occurred at 10% Kaolin at all phases of bacterial growth	Novakova 1977
¹²⁵ I-labeled <i>Pseudomonas aeruginosa</i> toxin	The in vitro adsorption of the toxin by Kaolin was investigated over a range of pHs	The maximum adsorption occurred at pHs below 4.1; minimal values occurred at pH 4.1, 7.4, and 8	Said, Shibal, and Abdullah 1980
Acetohexamide, tolazamide, and tolbutamide	In vitro (pH 7.4) and in vivo (rats) adsorption studies were carried out	All 3 drugs bound and acetohexamide had the greatest binding; the hypoglycemic activity of the 3 drugs were suppressed and blood glucose concentrations were increased; desorption of the drugs from Kaolin ranged from 1.8% to 24.5%	Said and Al-Shora 1980

(Continued on next page)

TABLE 8
Adsorption of various chemicals, cells, etc., to Silicate clays (*Continued*)

Compound adsorbed	Experimental design	Results	Reference
Coliphages T1 and T7 of <i>Escherichia coli</i>	1 ml suspensions of the coliphages were added to various concentrations of Kaolin	Adsorption of both coliphages by Kaolin were approximately the same 99%	Schiffenbauer and Stotzky 1982
Trimethoprim	The concentration of trimethoprim in the blood was determined at 0, 15, and 30 min and 1, 2, 4, and 6 h in the presence of Kaolin-Pectin	The mean decrease in the maximum blood concentration of trimethoprim was 29.42%	Babhair and Tariq 1983
Cationic surfactants: distearyl dimethyl ammonium chloride (74%); lauryl dimethylbenzyl ammonium chloride (50%)	A Kaolinite solution with added copper ions was added to surfactants and the metal ion uptake was recorded	Cationic surfactant result: the equilibrium between the metal ions and the organic cations was not effected	Beveridge and Pickering 1983
Anionic surfactants: sodium alkylbenzene sulphonate (80%); Monoethanolamine lauryl sulphate (34%); lauryl alcohol polyethylene condensate (28%)		Anionic surfactants: increased metal uptake by the clay was observed	
Nonionic surfactants: alcohol ethoxylates; tridecaml ethoxylate (90%); cetystearyl alcohol ethoxylates; stearic acid ethoxylate; cocnut monoethanolamide ethoxylate; octadecylamine ethoxylate; castor oil ethoxylate; nonyl phenol ethoxylates; dinonyl pheno ethoxylate; polypropylene glycol ethoxylates		Nonionic surfactants: many surfactants had no effect and some caused enhanced loss of the metal ions from solution	
<i>Escherichia coli</i> 0111 endotoxins (ETU 144, 150, and 153)	In vitro and in vivo endotoxin binding to Kaolin	In vitro Kaolin was an effective endotoxin binder and binding was pH dependent (lower pHs yielded better results); 300 mg of Kaolin eliminated endotoxemia, at pH 7.4, the ED ₅₀ was 900 mg	Ditter, Urbascek, and Urbascek 1983
Reovirus type 3	Chymotrypsin, ovalbumin, and lysozyme were added to Kaolinite and reovirus type 3	Chymotrypsin and ovalbumin reduced the adsorption of reovirus but lysozyme did not	Lipson and Stotzky 1984
Ampicillin and amoxycillin	4 g of Kaolin was ingested and 2 h later, 500 mg of the drugs were administered. This protocol was repeated 2 h later and urine (human) samples were collected	All volunteers showed reduced drug bioavailability following treatment; after 8 h, the reduced bioavailability for ampicillin ranged from 51.2 to 76.3 and 63.6 to 80.6 for amoxycillin	Khali, Mortada, and El-Khawass 1984b

(Continued on next page)

TABLE 8
 Adsorption of various chemicals, cells, etc., to Silicate clays (*Continued*)

Compound adsorbed	Experimental design	Results	Reference
Ampicillin and amoxycillin	In vitro adsorption and desorption studies to Kaolin (light, natural, and fine) were carried out at different pHs	The 3 types of Kaolin adsorbed only ampicillin and adsorption decreased as the pH increased; only partial release of the antibiotics was seen at pH 2.0 and 6.5	Khali, Mortada, and El-Khawas 1984a
Reovirus type 3 and coliphage T1	Competitive adsorption studies were carried out with Kaolin in estuarine water and distilled water	Reovirus type 3 and coliphage T1 did not share common adsorption sites on Kaolin and the coliphage did not interfere with the reovirus adsorption in estuarine water; the reovirus had no apparent effect on the adsorption of the phage in estuarine water	Lipson and Stotzky 1985
LT toxins of <i>Vibrio cholerae</i> and <i>Escherichia coli</i> , the ST toxin of ETEC, and the verotoxin of EHEC	Not specified	Kaolin inactivated the LT toxin and adsorption was a result of hydrogen bonding; it was ineffective against the verotoxin when the pH was alkaline; Kaolin was only slightly effective against the ST toxin	Brouillard and Rateau 1989
		Montmorillonite	
<i>Agrobacterium radiobacter</i>	The measurement of O ₂ uptake by calculating the respiration quotients (Q_{O_2}) was performed on all species of bacteria in the presence of 2% Kaolin with either adjusted (7.0) or unadjusted pHs	Montmorillonite spurred bacterial respiration by maintaining the initial pH; when the pH was adjusted to 7.0 respiration was its highest and similar to the buffered systems	Stotzky 1966
<i>Bacillus subtilis</i> , <i>Bacillus megaterium</i> , <i>Aerobacter aerogenes</i> , <i>Escherichia intermedia</i> , <i>Pseudomonas aeruginosa</i> and <i>P. aeruginosa</i> C-II, <i>Flavobacterium</i> species, <i>Proteus vulgaris</i>	The measurement of O ₂ uptake by calculating the respiration quotients (Q_{O_2}) was performed on all species of bacteria in the presence of 2% Kaolin with either adjusted (7.0) or unadjusted pHs	Montmorillonite increased the respiration of all species regardless of pH and characteristics of the bacteria primarily by maintaining the pH of the systems favorable for growth	Stotzky and Rem 1966
Mycelial homogenates of 27 species of fungi	Fungal mycelium and Montmorillonite were cultured together and the O ₂ uptake and pH were recorded	Montmorillonite concentrations <4% generally did not effect respiration; respiration was markedly inhibited at concentrations of 4% and above	Stozky and Rem 1967
Cationic drugs: chlorpheniramine maleate, amphetamine sulfate, and propoxyphene hydrochloride; Anionic drugs: not specified Nonionic drugs: xanthines, theophylline, and caffeine	Dissolution and dialysis were carried out in vitro	All the cationic drugs and certain nonionic drugs bound tenaciously; the anionic drugs and nonionic drugs that exist as nonionics bound very weakly and rapidly pass into solution	McGinity and Lach 1976

(Continued on next page)

TABLE 8
Adsorption of various chemicals, cells, etc., to Silicate clays (*Continued*)

Compound adsorbed	Experimental design	Results	Reference
Carbon tetrachloride, ethylene dibromide, trichloroethylene	10–1000 ppb/water of the three compounds were exposed to aluminum-saturated Montmorillonite and calcium-saturated Montmorillonite	Aluminum-saturated Montmorillonite absorbed 17% of trichloroethylene and 6% of the other cmpds; calcium-saturated Montmorillonite did not absorb carbon tetrachloride or trichloroethylene	Rogers and MacFarlane 1981
Coliphages T1 and T7 of <i>Escherichia coli</i>	1 ml suspensions of the coliphages were added to various concentrations of Montmorillonite	Adsorption of T1 coliphages by Montmorillonite was 84% and T7 was 96%	Schiffenbauer and Stotzky 1982
Cationic surfactants: distearyl dimethyl ammonium chloride (74%); lauryl dimethylbenzyl ammonium chloride (50%)	A Montmorillonite solution with added copper ions was added to surfactants and the metal ion uptake was recorded	Cationic surfactant result: metal ion uptake was reduced by competing surface sites	Beveridge and Pickering 1983
Anionic surfactants: sodium alkylbenzene aulphonate (80%); monoethanolamine lauryl sulphate (34%); lauryl alcohol polyethylene condensate (28%); Nonionic surfactants: alcohol ethoxylates; tridecaml ethoxylate (90%); cetystearyl alcohol ethoxylates; stearic acid ethoxylate; coconut monoethanolamide ethoxylate; octadecylamine ethoxylate; castor oil ethoxylate; nonyl phenol ethoxylates; dinonyl pheno ethoxylate; polypropylene glycol ethoxylates		Anionic surfactants: increased metal uptake by the clay was observed Nonionic surfactants: surfactants reduced the amount of metal ion adsorbed by the clay	
Reovirus type 3	Chymotrypsin, ovalbumin, and lyso-zyme were added to Montmorillonite and reovirus type 3	Chymotrypsin, ovalbumin, and lysozyme reduced the adsorption of reovirus	Lipson and Stotzky 1984
Poliovirus-1 (Lsc 2ab strain)	500, 15, 3 mg/L of Sodium Montmorillonite and the virus were suspended in seawater and the adsorption, desorption, and virus survival were studied	99.9% of the virus was absorbed in less than 30 min; 500 mg/L of Na-Montmorillonite significantly increased the survival duration of the virus and desorption tests showed elution of 76%	Gantzer, Quignon, and Schwartzbrod 1994
Reovirus type 3 and coliphage T1	Competitive adsorption studies were carried out with Montmorillonite in estuarine water and distilled water	Reovirus type 3 and coliphage T1 did not share common adsorption sites on Kaolin and the coliphage did not interfere with the reovirus adsorption in estuarine water or distilled water; the reovirus suppressed the adsorption of the coliphage in estuarine water	Lipson and Stotzky 1985

(Continued on next page)

TABLE 8
Adsorption of various chemicals, cells, etc., to Silicate clays (*Continued*)

Compound adsorbed	Experimental design	Results	Reference
	Pyrophyllite		
<i>Agrobacterium radiobacter</i>	The measurement of O ₂ uptake by calculating the respiration quotients (Q_{O_2}) was performed on all species of bacteria in the presence of 2% Kaolin with either adjusted (7.0) or unadjusted pHs	Pyrophyllite did not maintain a favorable pH for sustained respiration in either buffered or nonbuffered systems	Stotzky 1966
	Zeolite		
Zearalenone	5% of a synthetic anion-exchange zeolite and a cation-exchange zeolite and 250 $\mu\text{g/g}$ of zearalenone were added to the feed of rats	The anion-exchange zeolite was completely effective and the cation-exchange zeolite was not	Smith 1980
Aflatoxin B ₁	Two samples of natural Zeolites in different liquids were incubated with B ₁	The average aflatoxin retention rate was 605; effectiveness was lower in media containing nitrogen compounds	Dvora'k 1989

Bujdak and Rode (1996) reported peptide formation on the surface of three Montmorillonite samples. The Montmorillonite-catalyzed reaction produced diglycine and diketopiperazine from glycine.

Ferris et al. (1996) studied the catalytic properties of Na⁺-Montmorillonite by adding daily ImpA to a decanucleotide ([³²P]-dA(pdA)₈pA, where Im = imidazole; pA = adenosine-5'-phosphate; pdA = 3'-deoxyadenosine-5'-phosphate; ³²P = radioactively labeled phosphate group). Polyadenylates were formed after two additions of ImpA, with the main products being monomers ranging from 11 to 14. Polynucleotides, with more than 50 monomers, were formed after 14 additions. The principle oligomeric products contained 20 to 40 monomers.

Ertem and Ferris (1998) reported Montmorillonite-catalyzed ImpA and ImpA-A5' reactions. Oligomer yields decreased significantly when the addition of alkylammonium or aluminum poly oxo cations blocked the interlayer surfaces of the Montmorillonite particles.

Absorption, Distribution, Metabolism, and Excretion

Magnesium Trisilicate

Page, Heffner, and Frey (1941) measured the urinary excretion of silica in five men given 5 g of synthetic Magnesium Trisilicate orally for 4 consecutive days. Urine samples were collected for 24 h on the second day after the end of administration and analyzed for silica content. The mean 24-h excretion of all subjects was 16.2 mg of SiO₂. On the second, third, and fourth days after administration, the mean excretion rose to 172, 178, and 162 mg SiO₂. A total of 20 mg of Magnesium Trisilicate was taken and contained 9.2 g of SiO₂. An approximation of 5.2% SiO₂ excretion was estimated.

Benke and Osborn (1979) conducted a study in which groups of four to six male Sprague-Dawley Cox rats were fasted for 17 to 18 h and then were administered Magnesium Trisilicate orally in doses of 40, 200, or 1000 mg/kg of their body weight. Control animals received 10 ml of quartz-distilled water. All suspensions contained <0.5 ppm of silicon and aluminum. Urine samples were collected over an 8-h period, and the remaining urine in the bladder was collected afterwards. The concentrations of silicon was measured by induction-coupled radiofrequency (RF) plasma optical emission spectrometry. Silicon excretion was most rapid in the first 24 h after dosing. The control values were subtracted from the final values and the following number resulted. The urinary silicon excretion at 40, 200, and 1000 mg/kg Magnesium Trisilicate was 16.8%, 5.1%, and 1.5%, respectively.

Dobbie and Smith (1982) reported a 24-h urinary excretion study in which Si was determined by atomic absorption spectroscopy in one male and one female participant. A normal diet was given to the participants and four urine collections were made. A single dose of Magnesium Trisilicate was ingested at the beginning of the second 24-h collection. Magnesium Trisilicate doses given were as follows: 2, 5, and 10 g to the male subject and 2.5, 5, and 7.5, and 10 g in the female subject. The amount of Si excreted at the 5-g dose was greater than any other dose in the male subject and was greater than the 2.5- and 7.5-g doses in the female subject. The value of Si excretion for the male and female subjects were 3.63 and 3.31 mmol/day, respectively. Maximum excretion occurred in the first 24 h after ingestion.

The oral bioavailability of silicon and aluminum in Magnesium Trisilicate was studied by Cefali et al. (1995). Twelve female beagle dogs were administered a single 20-mg/kg dose of Magnesium Trisilicate and their blood was sampled at 0, 0.5, 1, 1.5, 2, 3, 4, 6, 8, 12, and 24 h after dosing. The plasma

samples were assayed for silicon and aluminum by graphite furnace atomic adsorption. No dogs displayed emesis, but four had soft stool. The area under the curve (AUC, mg · h/L), concentration maximum (C_{\max} , mg/L), and time maximum (T_{\max} , h) for silicon absorption was 8.8, 0.75, and 6.9, respectively. The AUC (mg · h/L), C_{\max} (mg/L), and T_{\max} (h) for aluminum absorption was 315, 24, and 5.7, respectively. There was no statistically significant absorption of aluminum from the aluminum containing compounds.

Montmorillonite

Retention of monodisperse and polydisperse Montmorillonite particles inhaled by dogs, rats, and mice was studied by Snipes, Boecker, and McClellan (1983a). Cations normally present in Montmorillonite were exchanged with ^{134}Cs . Polydisperse and monodisperse ^{134}Cs -labeled Montmorillonite suspensions were administered to groups of 40 rats and mice and to 120 beagle dogs by a multiport nose-only inhalation exposure system. Aerosol concentrations ranged from 10^{-3} to 10^{-1} mg of fused Montmorillonite per liter of air. Equal numbers of male and female rats and mice and 74 male and 46 female dogs were utilized. Exposure times for rats and mice ranged from 25 to 45 min and for dogs 15 to 50 min. All animals were whole-body counted for the labeled particles. Rats and mice were counted on exposure days 2, 4, 8, 16, 32, 64, 128, 256, 365, 512, 730, and 850 and the dogs were also counted on the same schedule, but also at 4, 5, 7, and 9 years after inhalation exposure. Excreta collections were made for animals from each exposure group. Five rats and five mice from each group were killed 4 h after exposure. The remaining rats and mice were killed at various times after exposure. Two dogs were scheduled for termination at times ranging from 4 h to 9 years. All animals were necropsied and tissues from lungs, lung-associated lymph nodes (LALNs), gastrointestinal tract, spleen, kidneys, abdominal lymph nodes, blood, skeleton, muscle, and skin were prepared for analysis of ^{134}Cs exposure. Results of the counts were converted into disintegrations per minute.

The mass of material deposited into the lungs of rats and mice was ~0.01 to 0.1 mg and for dogs was ~1 to 10 mg. The mass of Montmorillonite for all three species was <0.1 mg per gram of lung. Clearance of the initial ^{134}Cs occurred by dissolution and mechanical clearance. Mechanical clearance from the nasopharynx was rapid, and the clearance rate was decreased to a negligible value for all three species within a few days. Most initial deposit cleared via the gastrointestinal tract. Long-term mechanical clearance from the pulmonary region occurred at a constant rate for all species. Solubilization was the primary factor in long-term lung clearance for most particles inhaled by dogs and mechanical clearance was dominant in rats and mice. Most of the long-term clearance of deposited particles went to LALNs in dogs and occurred at a slower rate as compared to rats and mice. Rats and mice had a rapid clearance from the pulmonary region, where most of the mechanical clearance occurred via the gastrointestinal tract. Long-term clearance of the particles

in dogs occurred at 3500-day half-time in the lymph nodes and 6900-day half-time clearance in the gastrointestinal tract. The transport rate of the particles in the dog was 0.0002 day^{-1} of the lung burden. The long-term biological clearance half-term day was 690 days for rats and 490 days for mice. The lymph node accumulation process was modeled by a short-term process that became negligible after a few days (Snipes, Boecker, and McClellan 1983a).

Snipes, Muggenburg, and Bice (1983b) instilled radio-labeled (^{134}Cs) fused Montmorillonite particles into specific lung lobes or injected intraperitoneally into 32 beagle dogs. Necropsy was performed at 34, 182, and 365 days later. Specific sites of instillation included right apical lobe, right cardiac lobe, right diaphragmatic lobe, right intermediate lobe, left apical lobe, left diaphragmatic lobe, and intraperitoneal. Initial burdens in the peritoneal cavity or the lungs ranged from 0.50 to 14 μCi of ^{134}Cs for 29 dogs and from 42 to 64 μCi of ^{134}Cs for lung burdens for the other three dogs. Effective translocation half-time of lung instillations was 390 days. The accumulation rate of ^{134}Cs -labeled particles in the lymph nodes was 0.03% per day. Individual lung lobes cleared particles to one or two lymph nodes, and specific lymph nodes accumulated particles from one to three lung lobes. Lymph nodes that collected particles from the lung included the left mediastinal node, left tracheobronchial lymph node (TBLN), right TBLN, left middle TBLN, and right middle TBLN. The destination for translocated particles were primarily the nodes proximate to the tracheal bifurcation. Particles injected into the peritoneal cavity were translocated mainly to mesenteric lymph nodes and left sternal and right sternal lymph nodes. A small percentage of particles went to the left TBLN.

Zeolite

The oral bioavailability of silicon and aluminum in Zeolite A was studied by Cefali et al. (1995). Twelve female beagle dogs were administered a single 20-mg/kg dose of Zeolite A and blood was sampled at 0, 0.5, 1, 1.5, 2, 3, 4, 6, 8, 12, and 24 h after dosing. The plasma samples were assayed for silicon and aluminum by graphite furnace atomic adsorption. No dogs displayed emesis but four had soft stool. The AUC (mg · h/L), C_{\max} (mg/L), and T_{\max} (h) for silicon absorption was 9.5, 1.07, 7.9, respectively. The AUC (mg · h/L), C_{\max} (mg/L), and T_{\max} (h) for aluminum absorption was 342, 29, and 3.5, respectively. The AUC and C_{\max} values were elevated after the addition of the silicon containing compounds compared to the baseline and the AUC was significantly elevated. There was no statistically significant absorption of aluminum from the other aluminum-containing compounds.

In a study by Cefali et al. (1996), the bioavailability of silicon and aluminum in Zeolite A administered in either a capsule, an oral suspension, or an oral solution relative to an intravenous bolus infusion administered over a 1- to 1.5-min period was investigated. Twelve beagle dogs were given single doses of Zeolite A and their plasma samples, drawn at 0 and 36 h, were analyzed for silicon and aluminum concentrations by graphite furnace

atomic absorption. The plasma aluminum AUC values from the oral capsule and suspension were not statistically different from those during the control period. However, the aluminum AUC of the oral solution was statistically greater than the AUC of the corresponding control period. The extent of absorption of aluminum from the oral dosage forms was less than 0.1% relative to the intravenous infusion.

In Vitro Assays

Aluminum Silicate

Nadeau et al. (1987) tested Fiberfrax, an aluminum silicate, in several in vitro assays for red blood cell (RBC) hemolysis, lactate dehydrogenase activity (LDH), β -galactosidase (β -GAL) activity, lactic acid production, cellular ATP activity, and the cellular DNA contents. The mean length and diameter of this sample were determined to be 8.3 μm and 0.2 μm , respectively. Approximately 60% of this Fiberfrax sample was nonfibrous.

For the hemolysis assay, RBCs from rats were isolated and exposed to 100, 250, 500, 750, or 1000 $\mu\text{g}/\text{ml}$ of fibers for 1 h. The percentage of release of hemoglobin was compared with that of a fully lysed sample. The target cells for the other experiments were obtained by bronchoalveolar lavage from black hooded rats. Each of the experiments tested both fresh cell monolayers and 1-day-old monolayers. Fiber samples were added to the cultures at two doses, 33.3 $\mu\text{g}/\text{ml}$ and 166.7 $\mu\text{g}/\text{ml}$. LDH activity was based on the formation rate of NADH at 340 nm. The β -GAL activity was based on the measurement of *p*-nitrophenyl release. The amount of metabolite released from PAMs (pulmonary alveolar macrophages) into the medium was the measurement of lactic acid production. PAMs were treated with 1 ml of dimethyl sulfoxide to release the nucleotides and the ATP was measured later by a bioluminescence assay.

Fiberfrax particles produced no hemolytic activity at any concentration except 1000 $\mu\text{g}/\text{ml}$. Even at 1000 $\mu\text{g}/\text{ml}$, the particles had very weak hemolytic properties with only 2.0% hemolysis. In fresh PAM monolayers, Fiberfrax was very cytotoxic at 166.7 $\mu\text{g}/\text{ml}$. The extracellular releases of LDH and β -GAL were approximately 60% to 70% and 40% to 50%, respectively. A low cell viability was confirmed by an 80% decrease in ATP cell contents. Even at the lower dose, 33.3 $\mu\text{g}/\text{ml}$, a significant cytotoxic effect resulted, as judged by enzyme releases and ATP cell contents. Again in the day-old cultures, Fiberfrax was highly cytotoxic to PAM. LDH and β -GAL activities were as great and ATP cell contents were significantly decreased. At the lower dose, a moderate cytotoxic effect was observed. Decreases in lactic acid production were more pronounced at 166.7 $\mu\text{g}/\text{ml}$. No significant effect on total DNA cell content was noted in either the fresh or day-old cultures (Nadeau et al. 1987).

Attapulgit

Colony formation of human embryo intestinal cells (I-470) was examined by Reiss, Millette, and Williams (1980). At a dose of 0.001 to 1 mg/ml of Attapulgit with fibers $<2 \mu\text{m}$, colony

formation was not modified. Colony formation was inhibited by 35% and 43% at doses of 2.5 and 5.0 mg/ml, respectively.

Oscarson, Van Scoyoc, and Ahlrichs (1981) added Attapulgit to a culture of bovine RBCs to study the extent of hemolysis. Saline was added to cultures as a control and in a separate experiment, the polymer poly-2-vinylpyridine-*N*-oxide was also added to study its inhibiting effects. No other details were given. The concentration of Attapulgit that caused 50% hemolysis in 1 ml of a 3% solution of RBCs was determined as 0.06 mg Attapulgit/ml of silicate-erythrocyte-buffer suspension. A concentration of 0.2 and 1.0 $\mu\text{m}/\text{ml}$ of polymer caused 20% and 3% hemolysis, respectively. This was somewhat less hemolysis than without the polymer.

Chamberlain et al. (1982) tested two samples, one with short fibers and one with long fibers, of Attapulgit for their cytotoxicity in three cell lines: mouse peritoneal macrophages, human type II alveolar tumor (A549) cells, and Chinese hamster V79-4 lung cells. Attapulgit samples of 50, 100, and 150 $\mu\text{g}/\text{ml}^{-1}$ were added to mouse peritoneal macrophages for 18 h. The medium and cell lysates were assayed for LDH activity. The control received no dust sample. In the second experiment Attapulgit, 100 $\mu\text{g}/\text{ml}^{-1}$ and 200 $\mu\text{g}/\text{ml}^{-1}$, were added to A549 cultures and incubated for 5 days. The diameters of the cells were assessed for giant cell formation. The control treatment received no dust. In the last experiment, the survival of V79-4 cells in the presence of a series of concentrations of each dust was determined. Specific concentrations were not given. The cells and dust samples were incubated for 6 days and counted after the incubation. The controls received no dust.

The mouse macrophages released 57.7% LDH from interaction with 150 $\mu\text{g}/\text{ml}^{-1}$ of short fiber Attapulgit and was considered cytotoxic. However, the short fiber sample was considered inert to the A549 cells and V79-4 cells. The long fiber Attapulgit was cytotoxic to all three cell types. It was noted by investigators that mouse peritoneal macrophages are sensitive to both fibrogenic and carcinogenic dusts; whereas nonmacrophage cell lines such as V79-4 and A549 cells are insensitive to fibrogenic dusts but sensitive to the fiber morphology of carcinogenic dusts (Chamberlain et al. 1982).

Gormley and Addison (1983) investigated the cytotoxic effect of Attapulgit with a particle size of 2.6 μm . Clay suspensions, 20 and 80 $\mu\text{g}/\text{ml}$, were added to P388D1, a macrophage-type cell line for 48 h. Three sets of controls were included: a positive control, 20 μg of quartz DQ₁₂/ml; and two negative controls, 80 μg of TiO₂/ml, and an undusted set of cultures. The following assessments were made: cell viability; the activity of LDH; the activity of *p*-nitrophenyl-*N*-acetyl- β -D-glucosamide; L-(+)-Lactic acid production; and total cellular protein concentrations. Cellular viability was expressed as a percentage of the titanium dioxide control (100.0%) \pm the standard deviation. The 20- $\mu\text{g}/\text{ml}$ dose of Attapulgit produced a 65.8% \pm 9.2% viability and the 80 $\mu\text{g}/\text{ml}$ dose produced a 30.9% \pm 17.4% viability. Cellular LDH activities fell with decreasing cell viability, whereas the percentage of LDH in the medium increased.

Similar results were seen with glucosamidase. Also, the amount of lactate produced decreased as cell viability decreased. However, little change in the total cellular protein was recorded.

The induction of squamous metaplasia in tracheal organ cultures was investigated by Woodworth, Mossman, and Craighead (1983). Suspensions of Attapulgitte at concentrations of 1, 4, and 16 mg/ml were added to the mucosal surface of the tracheal explants for 1 h. After experimental treatments, extracts were transplanted to another surface more suitable for cell attachment. Mucocillary differentiation was maintained for 4 weeks and the explants were examined at 2, 4, and 6 weeks after exposure to Attapulgitte. The extent of squamous metaplasia was evaluated by SEM (scanning electron microscope). The explants were labeled with [³H]-thymidine and the labeling index was scored. Four weeks after exposure to Attapulgitte, the explants underwent both proliferative and metaplastic alteration. Attapulgitte induced an increase in metaplasia at low doses (1.0 and 4.0 mg/ml), but the increase was not statistically significant. The labeling index was also increased slightly but statistically significant. SEM was used to determine the association of fibers with metaplastic lesions. Most fibers aggregated at the margins of the explant, although small numbers of individual fibers were distributed along the mucosal surface. These fibers either rested on nonciliated cells or protruded into the mucosal surface. They were often encompassed by accumulations of epithelial cells. Metaplastic foci tended to be small. Many foci associated with the lesions but some were located at sites where no lesions could be seen.

The binding capacity, in vitro cytotoxicity, and percentage of hemolysis were investigated in a study by Harvey, Page, and Dumas (1984). Binding assays were carried out using the known carcinogens benzo(α)pyrene (B(α)P), nitrosonormicotine (NNN), and *N*-acetyl-2-aminofluorene (NAAF) and 2 mg/ml of Attapulgitte. A 2% suspension of sheep erythrocytes were added to 30 mg of Attapulgitte and incubated for 50 min. Cytotoxicity was measured using 1000 μ g of Attapulgitte and macrophage-like P399D1 cells and using the Trypan blue dye exclusion method. Hemolysis was calculated by measuring the optical density at 540 nm. All experiments included the positive control UICC chrysotile A and the negative control titanium dioxide. Chrysotile binds significantly more to all three carcinogens than the other fibers ($p < .005$) except Attapulgitte. Attapulgitte and chrysotile had very comparable binding capacities. Again Attapulgitte and chrysotile had the greatest hemolysis and cytotoxicity compared to the negative control. On a scale of 1 to 5, 5 being the greatest, Attapulgitte scored a 3.72 and 4.26 in hemolysis and cytotoxicity, respectively.

The cellular interactions between Attapulgitte and rat hepatocytes were examined in a study by Denizeau et al. (1985a). Primary cultures of rat hepatocytes were exposed to 10 μ g/ml of Attapulgitte fibers for 20 h. Ultrastructural analysis was performed by transmission electron microscopy. Fiber length was not indicated in this study. Fibers are phagocytized by the cells and numerous phagolysosomes are distributed throughout the

cytoplasm. The phagolysosomes also appear in the vicinity of charged vacuoles. Invaginations of the plasma membrane engulfing fibers and formation of vacuoles are identifiable. Deeper in the cytoplasm vacuoles with various shapes show the presence of fibers.

Beck and Bignon (1985) incubated leukemic mouse cells with two samples of 10, 50, or 100 μ g/ml of Attapulgitte. Viable cell counts were taken at 0, 24, 48, and 72 h. A positive control consisting of UICC amosite and untreated negative controls were also used in this experiment. The majority of fibers in the Attapulgitte samples were $< 1.0 \mu$ m. No evidence of cytotoxicity was measured over the 72-h period. The results from the Attapulgitte samples were indistinguishable from the untreated controls.

The cytotoxic effects of Attapulgitte on rabbit alveolar macrophages and rat pleural mesothelial cells were investigated by Jaurand et al. (1987). Attapulgitte samples with a mean fiber length of 0.77 μ m were added at concentrations 4 and 8 μ g/cm² to rabbit alveolar macrophage cultures for 4 and 20 h; control cultures received medium with no fibers. Enzyme release, activity of cytoplasmic LDH and lysosomal β -GAL was tested. The presence of LDH activity in cultures was the gauge of cytotoxicity and the presence of β -GAL was the gauge of cell stimulation. Attapulgitte at both concentrations was cytotoxic at 20 h. β -GAL release percentages for Attapulgitte and quartz after 20 h were almost identical.

Again Attapulgitte was added at concentrations of 1, 2, 4, and 10 μ g/cm² to rat pleural mesothelial cells. The cell number was determined daily with the use of a Nacet NS 1002 image analyzer. Attapulgitte was not cytotoxic except at 10 μ g/cm². At the lower doses, cell number increases were comparable to that of the controls (Jaurand et al. 1987).

Nadeau et al. (1987) tested Attapulgitte for its effects on cells in several in vitro assays for RBC hemolysis, LDH activity, β -GAL activity, lactic acid production, cellular ATP activity, and the cellular DNA contents. The mean length and diameter of this sample were determined to be 0.8 μ m and 0.1 μ m, respectively. The same study was conducted on Aluminum Silicate and all protocol and procedures are explained under that section. Attapulgitte particles produced no hemolysis except at 1000 μ g/ml. Even at 1000 μ g/ml, the particles showed very weak hemolytic properties with only 2.0% hemolysis. Analysis with the fresh PAM monolayers revealed Attapulgitte to be very cytotoxic at 166.7 μ g/ml. The extracellular releases of LDH and β -GAL were approximately 60% to 70% and 40% to 50%, respectively. A low cell viability was confirmed by an 80% decrease in ATP cell contents. Even at the lower dose, 33.3 μ g/ml, a significant cytotoxic effect resulted, as judged by enzyme releases and ATP cell contents. Again in the day old cultures, Attapulgitte was highly cytotoxic to PAM. LDH and β -GAL activities were very large and ATP cell contents were significantly decreased. At the lower dose, a moderate cytotoxic effect was observed. Decreases in lactic acid production were more pronounced at 166.7 μ g/ml. No significant effect on total DNA cell content was noted in either the fresh or day-old cultures.

Garcia, Dodson, and Callahan (1989) investigated the effects of Attapulgitte on cultures of human umbilical vein and bovine artery endothelial cell monolayers. Chrysotile asbestos was also studied as a positive control. Rapid phagocytosis of Attapulgitte and chrysotile particulates was evident in endothelial cell monolayers. Attapulgitte was markedly toxic according to a gradient of time-dependent and concentration-dependent endothelial cell injury measured by specific ^{51}Cr release. Chrysotile was much less toxic. Responses of bovine pulmonary artery and human vein endothelial cells to fiber phagocytosis and fiber-induced injury were similar. Fiber-mediated stimulation in human umbilical cell monolayers of the arachidonate metabolite prostacyclin paralleled endothelial injury. Attapulgitte was stimulatory in this experiment, whereas chrysotile was only weakly cytotoxic. Superoxide dismutase and catalase produced significant protection against fiber-mediated endothelial cell injury. Chelation by deferoxamine of elemental Fe in the fiber preparations was also protective.

Perderiset et al. (1989) reported the hemolytic activity of Attapulgitte on human red blood cells at five concentrations (0.05, 0.1, 0.2, 0.4, and 0.5 mg/ml). Additional studies tested the hemolytic activity of dipalmitoyl phosphatidylcholine (DPPC) and bovine serum albumin (BSA)-treated Attapulgitte (2 mg/ml). The mean fiber length was $<2 \mu\text{m}$. The percentage of hemolysis was determined by measuring the absorbance of the supernatant at 540 nm. At 0.5 mg/ml, Attapulgitte caused 82% hemolysis. The maximum amount of BSA adsorbed was $70 \pm 10 \mu\text{g}/\text{mg}$ of Attapulgitte, and the maximum occurred at an initial concentration of 200 $\mu\text{g}/\text{ml}$. For DPPC, the maximum amount of BSA adsorbed was $210 \pm 14 \mu\text{g}/\text{mg}$ of Attapulgitte, and the maximum occurred at an initial concentration of 250 to 300 $\mu\text{g}/\text{ml}$. Both compounds reduced the hemo-

lytic effect of Attapulgitte due to adsorption on the particle's surface.

Nolen, Langer, and Herson (1991) tested nine different samples of Attapulgitte for their membrane-lysing activity using human RBCs. The HC_{50} (concentration of particulate in $\mu\text{g}/\text{ml}$ required to lyse 50% of the erythrocytes in a suspension containing 1.8×10^8 cells/ml) was determined quantitatively. Three samples of Chrysolite were used as positive controls. No other details of the experiment were given. The fiber characteristics were determined by light microscopy and x-ray diffraction and the HC_{50} values are presented in Table 9.

Attapulgitte's cytotoxicity was investigated in rat pleural mesothelial cells (RPMCs) by Yegles et al. (1995). A suspension of 0.5 mg/ml of Attapulgitte was added to RPMCs, and a 3,(4,5-dimethyl-2-thiazolyl)-2,5-diphenyl-2H-tetrazolium bromide (MTT) viability test and anaphase/telophase abnormalities test were performed. The clay sample had no fibers measuring greater than 4 μm . Cytotoxicity was expressed as the concentration that provides 75% of cell viability compared to untreated controls (IC_{75}). Attapulgitte was only poorly toxic with an IC_{75} of $>100 \mu\text{g}/\text{cm}^3$. Untreated controls averaged about 3.4% of abnormal anaphases; no significant anaphase abnormalities were seen with Attapulgitte as well.

Bentonite

The hemolysis of human erythrocytes and methylene blue adsorption by two Bentonite samples were investigated by M'anyai et al. (1969). A white Bentonite sample consisted of 50% illite, 25% quartz, and 25% Montmorillonite; the yellow Bentonite sample consisted of predominately Montmorillonite. The data in Table 10 show that the hemolytic effect varied as a function of both of the amount of clay (mg) and the surface area (m^2).

TABLE 9
Fiber characteristics of nine Attapulgitte samples tested for their membranolytic activity using human red blood cells (Nolen, Langer, and Herson 1991)

Sample	Fiber character	Fiber length (μm)				HC_{50}^* ($\mu\text{g}/\text{ml}$)
		<1.0	1.1–5.0	5.1–10.0	>10.0	
1	Fibrous	71.5	26.3	1.7	0.5	400
2	Fibrous	92.7	7.1	—	—	Inactive
3	Nonfibrous	90.2	9.3	0.3	0.3	746
4	Fibrous	78.0	21.3	0.7	0.2	211
5	Fibrous	75.1	22.4	2.0	0.6	369
6	Nonfibrous	91.1	8.7	0.1	0.1	76
7	Nonfibrous	83.4	16.6	—	—	83
8	Nonfibrous	83.1	16.8	—	—	109
9	Fibrous	59.4	37.5	2.6	0.6	51
Chrysolite 1	Fibrous	77.2	20.5	1.8	0.5	41
Chrysolite 2	Fibrous	84.9	13.6	0.6	0.4	82
Chrysolite 3	Fibrous	88.8	10.6	0.4	0.2	59

*The HC_{50} is the concentration of silicate clay (in $\mu\text{g}/\text{ml}$) required to lyse 50% of the erythrocytes in a 1.8×10^8 cells/ml suspension.

TABLE 10
Hemolysis and methylene blue adsorption results (M'anyai et al. 1969)

Mineral	Sample description	50% hemolysis in 1 ml of a 2% erythrocyte suspension as function of:		Amount of methylene blue adsorbed by 1 m ² clay surface (mg)
		Amount of clay (mg)	Surface area of clay (m ²)	
Bentonite	White	1.66	0.039	3.59
Bentonite	Yellow	1.0	0.135	2.13
Montmorillonite	Ca-substituted	5.0	0.50	1.46
Montmorillonite	+Quartz	0.8	0.02	—
Kaolin		2.0	0.06	1.09
Kaolin	Fat	1.5	0.07	1.60
Kaolin	White	4.0	0.06	0.12
Kaolin	Pink	5.0	0.115	0.19

Beck and Bignon (1985) dosed peritoneal macrophages with two samples of Bentonite and the triphenyltetrazolium chloride (TTC) reduction, LDH activity, and methylene blue adsorption were used to assess cytotoxicity. One sample of Bentonite contained 3% SiO₂ and the other 34%. Bentonite inhibited TTC reduction similar to the fibrogenic dusts such as quartz. However, the extracellular LDH activity was not increased and methylene blue adsorption was very high.

Hatch et al. (1985) examined the cytotoxicity of Bentonite to rabbit alveolar macrophages. The alveolar macrophages were incubated with 1.0 mg/ml of Kaolin for 20 h at 37°C. Control cultures received 1.0 mg/ml of TiO₂. The viability percentage of the macrophages and the ATP content of the cells as index of cytotoxicity were determined. Bentonite caused a large reduction in both the viability and ATP levels. The viability index and ATP levels were presented as percentage reductions and were 64.7% and 92.0%, respectively. Controls figures were 18.3% and 0.7%, respectively.

TTC reduction, LDH activity, and methylene blue adsorption were measured as an index of cytotoxicity in a study by Adamis et al. (1986). Bentonite was added to peritoneal macrophages obtained from rats. No specific dose of Bentonite or other details were stated. TTC reduction was much greater and proved Bentonite to be cytotoxic. Extracellular LDH was almost half for Bentonite compared to control values. Methylene blue adsorption was significantly higher for Bentonite.

Murphy, Roberts, and Horrocks (1993a) investigated the cytotoxicity of Bentonite to human umbilical vein endothelial (HUVE) cells, undifferentiated N1E-115 neuroblastoma cells, and ROC-1 oligodendroglial cells. Indices of cytotoxicity used in this study were morphological examination, LDH activity, and fatty acid release. A suspension of Bentonite (1 to 2 μm in fiber length) was added to the cultures at concentrations of 0.1, 0.03, and 0.01 mg/ml and incubated for 1, 6, and 24 h.

Following incubations, the cells were examined morphologically. The medium and cells were extracted for free fatty acid quantitation. LDH activities were assayed after 24 h of incubation at a Bentonite concentration of 0.10 mg/ml.

Bentonite did not lyse ROC-1 oligodendroglial and the neuroblastoma cells and did not cause a dose-dependent increase in fatty acids at 24 h. No significant increases in LDH activity were detected utilizing any of these cell lines. However, Bentonite caused a dose-dependent increase in fatty acid concentrations only after 24 h of incubation. A 4.5-fold increase in fatty acid concentrations over control values was calculated. Increases over control activities of LDH were 141% with Bentonite. Within 1 h, Bentonite associated with the plasma membrane of HUVE cells and the morphology was drastically changed after treatment (no details given). Cell lysis was also apparent with treatment. After trypan blue staining, 94% of HUVE cells were nonviable with Bentonite treatment (Murphy, Roberts, and Horrocks 1993a).

In a separate study by Murphy et al. (1993b), the cytotoxicity of Bentonite was examined in two cell lines: primary murine spinal cord neurons and differentiated N1E-115 neuroblastoma cells. A clay suspension with a concentration of 0.1 mg/ml was added to the cultures. The neuronal cells were incubated for 1 h with Bentonite. Photomicrographs were taken at 5, 15, and 60 min following treatment. For the N1E-115 cells, incubation lasted 18 h and photomicrographs were taken at 5 and 15 min and 3, 6, and 18 h after the treatment. Morphological changes were observed using a phase contrast microscope. Within 5 min, clay particles were observed on the neuronal cell bodies. Cell bodies appeared granular within 15 min. The cells were completely lysed after 60 min and there was no evidence of any remaining cell bodies or processes. Cell membrane contact was apparent after 5 min in N1E-115 cultures. No morphological changes were apparent at this point. At 18 h, the cells were covered with

clay but cellular processes remained intact. N1E-115 cell lysis did not occur and no cytotoxicity was recorded as a result of Bentonite treatment.

Calcium Silicate

Hunt, Pooley, and Richards (1981) tested three samples of Calcium Silicate (A, B, and C) for biological reactivity in three in vitro test systems. Table 11 presents the differences in SiO₂ and Al₂O₃ percentages between the three samples.

In the first test system, 50, 100, 150, and 200 mg of the three samples of Calcium Silicate, UICC chrysotile (positive control), and titanium dioxide (negative control) were added to rabbit erythrocytes. The cultures were incubated for 50 min. The percentage of hemolysis was calculated. Rabbit erythrocytes were also incubated with 10, 30, and 50 mg heated, crushed samples of Calcium Silicate to calculate the percentage of hemoglobin binding. In the second study, rabbit alveolar macrophages were incubated with 5 mg of the Calcium Silicate samples for time intervals up to 60 min. The results were expressed as total viable cells. In the third study, sonicated Calcium Silicate samples (100 to 2000 μg) were added to rabbit lung fibroblasts. On days 7, 10, 17, and 24 after treatment, the cultures were analyzed for cellular DNA, protein, other cellular material, and hydroxyproline. Cytological studies on the same cells were carried out using dust concentrations of 50 to 400 μg and staining the cultures to visualize reticulin fibers.

In order to obtain 20% hemolysis, 0.4 mg of chrysotile, 2.8 mg of A, 25.0 mg of B, and 15.0 mg of C are required. Titanium dioxide did not produce 20% hemolysis at any concentration. Sonication of all samples enhanced hemolysis and a "respirable" preparation of A had the same hemolytic activity as chrysotile. Sample B binds more hemoglobin than A or C but not more than chrysotile. Samples B and C had enhanced hemolytic activity when heated above 300°C. Heating had no effect on sample A. All samples produced similar macrophage mortality and at concentrations of 5 mg, only 60% of the cells were surviving at 60 min. Chrysotile at 5 mg resulted in a 20% viability. Samples A and B produced greater DNA and protein concentrations at day 7. However, sample A induced greater protein concentrations at day 24 with normal hydroxyproline levels. Sample B at day 24 had decreased concentrations of protein and hydroxyproline with an increase in mineral concentration. Sample A produced few changes in fibroblast morphology and reticulin deposits.

TABLE 11

Aluminum and Silicon content in Calcium Silicate samples used in biological reactivity study (Hunt, Pooley, and Richards 1981)

Calcium Silicate sample	SiO ₂ %	Al ₂ O ₃ %
A	57.3	2.6
B	52.3	4.4
C	53.7	1.0

TABLE 12
Sample characteristics of five Calcium Silicates tested for hemolytic activity in vitro (Skaug and Gyseth 1983)

Sample	Chemical formula	SiO ₂ %	Fibrous character
CaSi A, natural wollastonite	CaSiO ₃	—	+++
CaSi B, natural wollastonite	CaSiO ₃	2	+
CaSi C, synthetic wollastonite	CaSiO ₃	9	—
CaSi D, synthetic tobermorite	Ca ₅ Si ₆ O ₁₇ · 2.5 H ₂ O	10	—
CaSi E, synthetic tobermorite	Ca ₅ Si ₆ O ₁₇ · 2.5 H ₂ O Ca ₆ Si ₆ O ₁₇ (OH) ₂	2	+

Sample B produced sparse and irregular deposition of reticulin (Hunt, Pooley, and Richards 1981).

Skaug, Davies, and Glyseth (1984) tested five Calcium Silicate dust samples for hemolytic activity in vitro. Electron microscopy and x-ray diffractions techniques were used to characterize the Calcium Silicates and the results are presented in Table 12. The Calcium Silicate samples A to E, chrysotile B (positive control), and titanium dioxide were added to RBCs at concentrations of 0, 5, and 10 mg/ml. The effect of sonication of the dust samples and the addition of 30 mM CaCl₂, EDTA, and EGTA were also investigated. Sample E produced the greatest hemolysis at nearly 40%. The hemolytic activity of the synthetic Calcium Silicate samples were greater. In all experiments, greater dust concentrations increased hemolysis. Sonication increased the hemolytic activity of the synthetic samples but had no effect on the natural samples. The 30 mM CaCl₂ increased the hemolysis of samples D and E, but not C. EDTA did not decrease hemolysis for samples D and C, and EGTA did not inhibit hemolysis of samples B, C, D, and E.

Five samples of Calcium Silicate also were used to test cytotoxic effects on mouse peritoneal macrophages in vitro. Calcium Silicate concentrations of 0, 20, 40, and 60 μg/cm³ were added to mouse peritoneal macrophages for 18 h. The medium and cell lysates were assayed for LDH and β-glucuronidase (β-GLUC). The positive-control dust utilized was DQ12 quartz standard and the negative-control dust was magnetite. Characterization of the five samples were carried out by means of x-ray diffraction and scanning electron microscopy. The results of the mineral characterization are presented in Table 13. The samples A, B, C, and D had little effect on LDH release but sample E, the fibrous tobermorite, was clearly cytotoxic. Samples A and B caused release of large levels of β-GLUC. Sample E also caused the release of significant amounts of β-GLUC due to its cytotoxicity. Samples C and D caused the release of amounts comparable to the negative controls (Skaug, Davies, and Glyseth 1984).

TABLE 13
Mineral characterization of five samples of Calcium Silicate used to test cytotoxic effects on mouse peritoneal macrophages in vitro (Skaug, Davies, and Glyseth 1984)

Sample	Description	Chemical formula	% SiO ₂ added	Presence of fibers
A	US wollastonite	CaSiO ₃	—	+
B	Natural wollastonite	CaSiO ₃	2	+
C	Synthetic wollastonite	CaSiO ₃	9	—
D	Synthetic tobermorite	Ca ₅ Si ₆ O ₁₇ · 2.5 H ₂ O	10	—
E	Synthetic tobermorite and xonotlite	Ca ₅ Si ₆ O ₁₇ · 2.5 H ₂ O Ca ₆ Si ₆ O ₁₇ (OH) ₂	2	+

Hectorite

In a study by Gormley and Addison (1983) mentioned earlier, the cytotoxic effects of Hectorite were investigated. The Hectorite sample had a particle size of 2.8 μm . The procedures are detailed in the study under the Attapulgit heading. Cellular viability was expressed as a percentage of the titanium dioxide control (100.0%) \pm the standard deviation. The 20- $\mu\text{g}/\text{ml}$ dose of Hectorite produced an 83.4% \pm 10.9% viability and the 80 $\mu\text{g}/\text{ml}$ dose produced a 56.4% \pm 13.3% viability. Cellular LDH activities decreased with decreasing cell viability while the activity of LDH in the medium increased. Similar results were seen with glucosaminidase. Also, the amount of lactate produced decreased as cell viability decreased. However, little change in the total cellular protein was recorded.

Banin and Meiri (1990) reported that they added Hectorite to murine neuroblastoma cells at a concentration range of 70 to 1000 $\mu\text{g}/\text{ml}$, although details were not provided. They concluded that clear morphological signs of cell deterioration were evident and, at the concentrations listed, an acute toxic effect was seen.

Kaolin

Results from a study by M'anyai et al. (1969) on the hemolysis and methylene blue adsorption by Kaolin are presented in Table 10.

Kaolin was heated to temperatures of 290°C, 350°C, 500°C, 650°C, 800°C, and 950°C and changes in the internal structure and surface properties were investigated and compared to alterations in hemolytic activity in vitro. The measurement of methylene blue adsorption and investigation of the crystal structure by x-ray diffraction were made. In addition, Kaolin was added to human erythrocytes and the amount of lysed hemoglobin release was determined following an 1-h incubation. Complete dehydration of Kaolin resulted in the formation of metakaolinite between the temperatures 500°C to 650°C. The formation of metakaolinite resulted in complete loss of hemolytic activity. Heating to higher temperatures, 800°C and 950°C, resulted in the formation of $\gamma\text{-Al}_2\text{O}_3$ (mullite) or SiO₂ (cristobalite), which led to greater intensification of hemolytic activity. The extent of hemolysis depended on the crystal structure and hydration of the surface (M'anyai et al. 1970).

Oscarson et al. (1981) added Kaolin to a culture of bovine RBCs to study the extent of hemolysis. Saline was added to cultures as a control and in a separate experiment, the polymer poly-2-vinylpyridine-*N*-oxide was also added to study its inhibiting effects. No other details were given. The concentration of Kaolin that caused 50% hemolysis in 1 ml of a 3% solution of RBCs was determined as 0.6 mg Kaolin/ml of silicate-erythrocyte-buffer suspension. A concentration of 0.2 and 1.0 $\mu\text{M}/\text{ml}$ of polymer caused 50% and 20% hemolysis, respectively. This was somewhat less hemolysis than without the polymer.

Mossman and Craighead (1982) adsorbed 3-Methylcholanthrene (3MC) onto heat-sterilized preparations of Kaolin (4, 8, and 16 mg dust/ml medium). The tracheas of female golden Syrian hamsters were excised, and prepared for organ cultures and exposed to 3MC/Kaolin preparations. After 4 weeks in vitro, the organ cultures were examined morphologically or implanted subcutaneously into syngeneic weanling female hamsters. The hamsters were palpated for tumors at 3-week intervals and any masses >5 mm in diameter were excised. Animals with no tumors were killed at 105 to 110 weeks of age and the tracheal implants were removed. The tracheal organ cultures and tumors were fixed for microscopic examination. Explants exposed to Kaolin had differentiated mucociliary epithelium for periods of several weeks. In vitro the columnar mucosal cells acquired a cuboidal configuration and the foci of the epithelial hyperplasia appeared at sites where microscopically evident accumulations of particles were deposited on the tracheal epithelium. No keratinizing squamous metaplasia was evident. Neoplasms developed in the tracheal implants exposed to 3MC-coated Kaolin. Tumor development was dosage dependent. No sarcomas developed only carcinomas. In the highest Kaolin/3MC-treated group, 28% of the animals developed tumors. Tumors failed to develop in tissues treated with Kaolin alone.

The comparative effects of Kaolinite (Kaolinite is the raw mineral that comprises Kaolin) on cellular and artificial membranes were examined using three test systems: tracheal epithelial cells, sheep erythrocytes (RBCs), and preparations of phospholipid-cholesterol vesicles in a study by Woodworth, Mossman, and Craighead (1982). Kaolinite doses of 0.003, 0.01, 0.03, and 0.1 mg/ml were added to tracheal epithelial cells for 24 h. Control cultures received no particulate. The ⁵¹Cr release

was determined by liquid scintillation. Spontaneous release was determined from the control cultures. The second experiment, a hemolytic assay, combined RBC and Kaolinite doses of 0.1, 0.5, 1.0, 5.0, and 20.0 mg/ml were added at 37°C for 1 h. The optical density was determined at 540 nm. One milliliter of the preparation of liposomes (11.5 µg lipids) was added to 1 ml of a Kaolinite suspension. After 1 h, the optical density of the mixture was measured at 380 nm. The percentage of CrO_4^{2-} release was calculated. Control cultures received no particulate.

Kaolinite induced release of ^{51}Cr by tracheal epithelium was almost 50% at the highest dose. The cells phagocytized the particles, as demonstrated by SEM and phase-contrast microscopy. This process was most evident after 24 h. Cells containing intracellular particles demonstrated retraction of lamellopodial extensions, surface blebbing, and a change in morphology from flattened to round.

A dose-dependent relationship between mineral concentration and hemolysis was demonstrated. Hemolysis was rapid. Approximately 50% of the RBCs were hemolyzed within 10 min. SEM revealed remnants of RBCs in cultures with complete hemolysis.

CrO_4^{2-} release at 10 mg/ml of Kaolinite was ~35% after 1 h. A dose-dependent relationship between particle concentration and CrO_4^{2-} release was again demonstrated (Woodworth, Mossman, and Craighead 1982).

In a study by Gormley and Addison (1983) described earlier, the cytotoxic effects of two Kaolins (K-1 and K-2) were investigated. K-1 had a particle size of 3.2 µm, and K-2 had a particle size of 3.9 µm. The procedures are detailed in the study Gormley and Addison (1983) under the Attapulgitte heading.

Cellular viability was expressed as a percentage of the titanium dioxide control (100.0%) ± the standard deviation. The 20-µg/ml dose of Kaolin (K-1) resulted in a 101.4% ± 6.7% viability and the 80-µg/ml dose produced a 69.5% ± 6.5% viability. With a 20-µg/ml dose of Kaolin (K-2), viability was 93.6% ± 4.5%, with the 80 µg/ml dose, it was 60.0% ± 4.1%. It may be noted that K-1 has a finer particle size but a smaller surface area as compared to K-2. Cellular LDH activities decreased with decreasing cell viability, whereas the percentage of LDH in the medium increased. Similar results were seen with glucosaminidase. Also the amount of lactate produced decreased as cell viability decreased. However, little change in the total cellular protein was recorded (Gormely and Addison 1983).

The cytotoxicity of Kaolinite toward mouse peritoneal macrophages was examined in a study by Davies et al. (1984). This three-part study investigated whether or not respirable china clay (Kaolinite) was cytotoxic toward macrophages in vitro, the components responsible for the toxicity, and the factors responsible for the components toxicity. The assessment of toxicity was indicated by the activity of LDH assayed from the medium and cell lysates.

China clay dusts (60 µg/culture) from 12 separate drying plants were added to mouse peritoneal macrophage cultures and incubated for 18 h. The medium and cell lysates were collected

and assayed for LDH activity. All 12 cultures had changes that indicated dust cytotoxicity. Between 19.5% and 60.0% LDH was released from the cultures. Four other dust samples, three of quartz (5,10,15, 20 µg/culture) and one of magnetite, were also assayed. The cytotoxicity of quartz indicated a dose-dependent relationship and was quite toxic. The magnetite dust had little effect on LDH release.

Mineral composition of the dusts was determined using x-ray diffraction analysis. A summary of the dust samples' composition was as follows: Kaolinite (84% to 96%), mica (3% to 6%), quartz (1%), and feldspar (0% to 7%). Due to the possibility of other dust cytotoxicity, the biological effects of the ancillary minerals and Kaolin was studied. Two high-purity Kaolins were tested in the same method as above and were clearly cytotoxic toward the macrophages. By x-ray diffraction, these two Kaolins were both 98% pure Kaolin. The feldspar sample had lower activity than titanium dioxide, a material considered nonfibrogenic and is used as a control dust in cell studies. The mica dust samples were cytotoxic but much lower than that of the Kaolin. By mineral analysis, it was found that mica dusts had 34% Kaolinite. Quartz was ruled out as the cytotoxic agent due to the very low concentrations (1%) in the initial experiment.

In a separate experiment, Kaolin pretreated with poly-2-vinyl pyridine-*N*-oxide (PVPNO) (0.45 µg/mg), was added to mouse peritoneal macrophages. (Note: PVPNO has been demonstrated to reduce the cytotoxicity of Kaolin [Davies and Preece 1983]). Electron micrographs were taken of the macrophages with and without the pretreated Kaolin for analysis of the factors causing the toxicity. The ultrastructural alterations and number of particles within the cells appeared to be similar in both the treated and nontreated cultures. It was concluded that PVPNO has no effect on the inhibition of the uptake of Kaolin. Dust particles were found adjacent to cell surfaces and in membrane-bound intracytoplasmic vesicles. However, no particles penetrated or were seen penetrating the nucleus and no lysed cells were seen.

In the last set of experiments, the physical structure of Kaolin and how it relates to dust toxicity was studied. Four components of Kaolin's structure were examined: gibbsite or mica-like surfaces, positively charged edges, negative charged particles, and an amorphous 'gel' coating on kaolinite. Transmission electron micrographs of gibbsite or mica-like surfaces indicated low toxicity and were ruled out as a possible marked toxic factor. A colloidal gold decoration technique was to study the positively charged edges of Kaolinite. Gold binds to the positively charged particles of Kaolinite and treatment of polyacrylic acid abolishes the gold decoration. In this study, mouse peritoneal macrophages were incubated with polyacrylic treated Kaolin (120 µg/culture). Only a small drop in the cytotoxicity of Kaolin was observed. The electrophoretic mobility of negatively charged Kaolin particles was also studied. Increased amounts of ammonium chloride produced a significant decrease in electrophoretic mobility. It is important to note that the greater concentrations did not produce negatively charged Kaolin particles. These same aluminum-treated Kaolins were added to mouse

peritoneal macrophages (120 $\mu\text{g}/\text{culture}$) and the cytotoxicity changed very little based on the amount of LDH activity released. The last experiment examined the effect of the amorphous 'gel' coating of Kaolin and its cytotoxicity. Plasma-ashing and the same LDH assay were performed on the samples. The first group, Kaolin (40 mg/cm^3), was plasma-ashed after 24 h and no effect was observed. Plasma-ashing after 72 h did reduce cytotoxicity. The second group of Kaolin dusts were mixed with formalin-fixed lung tissue and then immediately plasma-ashed. The cytotoxicity was not reduced. The last groups included Kaolin recovered from air-dried lungs of Fischer rats exposed to china clay dust (10 mg/m^3) for 40 h/week for 1 year, left for 1 year, then ashed to a constant weight. Inhalation of these dusts was significantly less toxic. Reductions in cytotoxicity was probably due to alterations in the surface coating of Kaolin (Davies et al. 1984).

Beck and Bignon (1985) dosed peritoneal macrophages with a sample of Kaolin and the TTC reduction, LDH activity, and methylene blue adsorption were used to assess cytotoxicity. The sample contained 30% SiO_2 . The results from this study classified Kaolin as an inert dust and nontoxic. Methylene blue adsorption was slight.

Gormley, Kowolik, and Cullen (1985) used luminol-dependent chemiluminescence (CL) to assess the *in vitro* production of reactive oxygen species by human neutrophils and monocytes after exposure to Kaolinite. Either opsonized or nonopsonized Kaolinite dust was added to either neutrophil or monocyte suspensions and luminol. The suspensions were assayed for CL and measured in millivolt. Concentrations of dust ranged from the maximum of 3 mg/ml downwards. A control suspension of zymosan (2 mg/ml) was also assayed for CL production. Neutrophils challenged with opsonized dust had relatively low dose-dependent CL production compared to controls. However, when neutrophils challenged with nonopsonized dust, CL production peaked at 67%. Again dose-dependent responses were obtained when monocytes were tested. However, monocytes had a greater CL response in the presence of opsonized dust. These results were the reverse of the earlier neutrophil responses as a very low monocyte CL production was obtained with nonopsonized dust.

In a study by Wallace et al. (1985), the cytotoxicity of native and surface-modified Kaolin and the effect of pulmonary surfactant were studied. Cell membrane damage and cytotoxicity were measured by the release of alveolar macrophage cytoplasmic enzyme LDH, the lysosomal enzymes β -n-acetylglucosaminidase (β -NAG) and β -GLUC, and sheep blood cell hemolysis. Dipalmitoyl lecithin (DPL) emulsions made from synthetic L- α -lecithin β,γ -dipalmitoyl were added to Kaolin to produce a concentration of 7.5 mg dust/ml. Controls of saline and Kaolin without DPL were also utilized. For the hemolysis assays, the mixtures were resuspended in phosphate-buffered saline (PBS) at a concentration of 2.0 mg dust/ml PBS.

Fresh sheep blood erythrocytes were mixed with dust suspensions in concentrations of 0.1 to 1.0 mg/ml . Untreated Kaolin

and DPL-treated Kaolin erythrocytes were incubated for 1 h at 37°C. Negative controls were made with erythrocytes in PBS and positive controls were made by lysing erythrocytes. All samples were read at 540 nm using a spectrophotometer and the percentage of lysis was calculated. The lecithin treated Kaolin suppressed erythrocyte activity to near "background levels." The hemolysis value for the maximum nontreated Kaolin concentration (1 mg/ml) was 42%, whereas the hemolysis value for the lecithin-treated Kaolin at the same concentration was 2%. Adsorption isotherm data estimated that 0.1 mg Lecithin/ mg Kaolin would provide full surface coverage and suppress the hemolytic capacity to 97% lower than the native Kaolin.

In the second experiment of the same study, alveolar macrophage enzyme release studies were carried out using macrophages from Sprague-Dawley rats. Untreated Kaolin and DPL-Kaolin samples at a concentration of 1 mg/ml were mixed with macrophages and incubated for 2 h at 37°C. The results were similar as in the above experiment. The nontreated Kaolin caused release of enzymes: 570% LDH, 600% β -GLUC, and 570% β -NAG of the control values. The treated Kaolin did not cause the release of these enzymes. These results imply that Kaolin damages erythrocytes and macrophages through cell membrane-dust surface interactions and that pulmonary surfactants can absorb the mineral surfaces for a short time (Wallace et al. 1985).

Mossman and Be'gin (1989) conducted a study in which Kaolin samples were coated with the enzymes L-alpha-dipalmitoyl glycerophosphorylcholine (DGPL) and phospholipase A₂ (PLA₂) and the hemolytic potential of both coated and noncoated samples were studied *in vitro*. The samples were incubated with sheep erythrocytes and the optical density of the supernatant at 540 nm was determined to measure hemoglobin release. With increasing amounts of DGPL, neutralization of the hemolytic potential occurred at 75 to 85 mg DGPL/ g of Kaolin. The residual adsorbed value was 83.0 mg DGPL/ g Kaolin. The digestive removal of DGPL by Kaolin was measured at the applied specific activity of 0.96 units PLA₂ per molecule DGPL on Kaolin. Most of the produced lysolecithin remains adsorbed at 2 h.

Banin and Meiri (1990) added Kaolinite to murine neuroblastoma cells at concentrations of 100 to 1000 $\mu\text{g}/\text{ml}$. Within minutes, the Kaolinite increased the increasing permeability of the membranes, depolarized resting potential, and the maintaining action potentials in response to stimulation were lost. Within 30 min, the cells had alterations of morphological deterioration. Microvilli retracted, the surface assumed an unruffled, smooth appearance, and large holes developed in the plasma membrane.

Murphy, Roberts, and Horrocks (1993a) investigated the cytotoxicity of Kaolinite using three cell lines: HUVE cells, undifferentiated N1E-115 neuroblastoma cells, and ROC-1 oligodendroglial cells. Indices of cytotoxicity used in this study were morphological examination, LDH activity, and fatty acid release. Exact experimental details are provided in the Bentonite section under the same heading.

Kaolinite did not lyse ROC-1 oligodendroglia and the neuroblastoma cells and did not cause a dose-dependent increase in fatty acids at 24 h. No significant increases in LDH activity were detected utilizing either of these cell lines. However, Kaolinite increased fatty acid concentrations after 24 h of incubation in a dose-dependent fashion. A 1.7-fold increase in fatty acid concentrations over control values was calculated. Increases over control activities of LDH were 146% with Kaolinite. Within 1 h, Kaolinite associated with the plasma membrane of HUVE cells and the morphology was drastically changed after treatment (no details given). Cell lysis was also apparent. After trypan blue staining, 90% of HUVE cells were nonviable with Kaolinite treatment (Murphy, Roberts, and Horrocks 1993a).

Kaolinite dust was tested for potential human leukocyte elastase (HLE)-inhibiting effects (Oberson et al. 1996). HLE inhibition was evaluated by incubating 15 nM HLE for 1 h in the presence of 5 μg of Kaolinite. Suc(Ala)₃pNA was then added for 30 min. Activity was measured at 410 nM. The 5 μg Kaolinite abolished (90% inhibition) the activity of 0.45 μg HLE.

Montmorillonite

Results from a study by M'anyai et al. (1969) on the hemolysis and methylene blue adsorption by Montmorillonite are presented in Table 10.

Oscarson, Van Scoyoc, and Ahlrichs (1981) added Montmorillonite to a culture of bovine RBCs to study the extent of hemolysis. Saline was added to cultures as a control and in a separate experiment, the polymer, poly-2-vinylpyridine-*N*-oxide, was also added to study its inhibiting effects. No other details were given. The concentration of Montmorillonite that caused 50% hemolysis in 1 ml of a 3% solution of RBCs was determined as 0.006 mg Montmorillonite/ml of silicate-erythrocyte-buffer suspension. A concentration of 0.2 and 1.0 μM /ml of polymer reduced hemolysis to 23% and 0%, respectively.

The comparative effects of Montmorillonite on cellular and artificial membranes were examined using three test systems—tracheal epithelial cells, sheep erythrocytes (RBCs), and preparations of phospholipid-cholesterol vesicles—in a study by Woodworth, Mossman, and Craighead (1982). Montmorillonite doses of 0.003, 0.01, 0.03, and 0.1 mg/ml were added to tracheal epithelial cells for 24 h. Control cultures received no particulate. The ⁵¹Cr release was determined by liquid scintillation. Spontaneous release was determined from the control cultures. A second experiment, a hemolytic assay, combined RBC and Montmorillonite doses of 0.1, 0.5, 1.0, 5.0, and 20.0 mg/ml at 37°C for 1 h. The optical density was determined at 540 nm. Control cultures received no particulate. One milliliter of the preparation of liposomes (11.5 μg lipids) was added to 1 ml of a Montmorillonite suspension. After 1 h, the optical density of the mixture was measured at 380 nm. The percentage of CrO₄²⁻ release was calculated. Control cultures received no particulate.

Montmorillonite induced release of ⁵¹Cr by tracheal epithelium was almost 60% at the highest dose. The cells phagocytized the particles, as demonstrated by SEM and phase-contrast

microscopy. This process was most evident at after 24 h—Cells containing intracellular particles demonstrated retraction of lamellopoidal extensions, surface blebbing, and a changed morphology from flattened to round.

A dose-dependent relationship between mineral concentration and hemolysis was demonstrated. Hemolysis was rapid. Approximately 50% of the RBCs were hemolyzed within 10 min. SEM revealed remnants of RBCs in cultures exhibiting complete hemolysis.

CrO₄²⁻ release at 10 mg/ml of Montmorillonite was ~40% after 1 h. A dose-dependent relationship between particle concentration and CrO₄²⁻ release was again demonstrated (Woodworth, Mossman, and Craighead 1982).

In the Gormley and Addison study (1983) described earlier, the cytotoxic effects of three samples of Montmorillonite (CaM-1, CaM-2, and NaM) were investigated. CaM-1 and -2 have calcium substitutions in their lattices whereas NaM has sodium substitutions. Particle sizes ranged from 2.0 to 3.1 μm . The procedures are detailed under the Attapulgite heading. Cellular viability was expressed as a percentage of the titanium dioxide control (100.0%) \pm the standard deviation. The 20- μg /ml dose of CaM-1 with particle size of 3.1 μm produced a 79.1% \pm 19.2% viability and the 80- μg /ml dose produced a 51.9% \pm 15.6% viability; CaM-2 with a particle size of 2.5 μm produced viabilities of 21.2% \pm 3.5% (20 μg /ml) and 13.1% \pm 2.2% (80 μg /ml); and NaM with a particle size of 2.0 μm produced viabilities of 47.3% \pm 7.4% (20 μg /ml) and 37.2% \pm 4.6% (80 μg /ml). The sample CaM-1 had the largest surface area, whereas sample NaM, had the smallest. Sample CaM-2 had the lowest viability percentage despite the median particle size and surface area. Investigators attributed the marked toxicity of sample CaM-2 due to the presence of ~1% of quartz and 10% cristobalite in the sample. Sample NaM, which also exhibited a greater toxicity, contained ~5% quartz and ~2% calcite. Cellular LDH levels fell with decreasing cell viability whereas the percentage of LDH in the medium increased. Similar results were seen with glucosaminidase. Also, the amount of lactate produced decreased as cell viability decreased. However, little change in the total cellular protein was recorded.

Gormley, Kowolik, and Cullen (1985) used luminol-dependent CL to assess the in vitro production of reactive oxygen species by human neutrophils and monocytes on exposure to Montmorillonite. Either opsonized or nonopsonized Montmorillonite (containing a calcium as its exchange ion) dust was added to either neutrophil or monocyte suspensions and luminol. The suspensions were assayed for CL and measured in millivolt. Concentrations of dust ranged from the maximum of 3 mg/ml downwards. A control suspension of zymosan (2 mg/ml) was also assayed for CL production. Neutrophils challenged with opsonized dust resulted in relatively low dose-dependent CL production compared to controls. However, when neutrophils were challenged with nonopsonized dust, a marked response of CL peak production at 114% was elicited. Again dose-dependent responses were obtained when monocytes were tested. However,

monocytes elicited a slightly higher response in the presence of opsonized dust. These results proved to be the reversal of the earlier neutrophil responses. A very low monocyte CL production was obtained with nonopsonized dust.

Banin and Meiri (1990) reported a study in which Montmorillonite was added to murine neuroblastoma cells at a concentration range of 100 to 1000 $\mu\text{g/ml}$, but no details were given. The authors concluded that clear morphological signs of cell deterioration were evident and, at the concentrations listed, an acute toxic effect was seen.

Murphy, Roberts, and Horrocks (1993a) investigated the cytotoxicity of Montmorillonite to three cell lines: HUVE cells, undifferentiated N1E-115 neuroblastoma cells, and ROC-1 oligodendroglial cells. Indices of cytotoxicity used in this study were morphological examination, LDH activity, and fatty acid release. Exact experimental details are provided in the Bentonite section under the same heading.

Montmorillonite did not lyse ROC-1 oligodendroglia and the neuroblastoma cells and did not cause a dose-dependent increase in fatty acids at 24 h. No significant increases in LDH activity were detected utilizing either of these cell lines. However, Montmorillonite caused a dose-dependent increase in fatty acid levels only after 24 h of incubation. A 10-fold increase in FA levels over control values was calculated. Increases over control activities of LDH were 154%. Within 1 h, Montmorillonite associated with the plasma membrane of HUVE cells and the morphology was drastically changed after treatment (no details given). Cell lysis was also apparent with treatment. After trypan blue staining, 99% of HUVE cells were nonviable with Montmorillonite treatment (Murphy, Roberts, and Horrocks 1993a).

In a study by Murphy et al. (1993b), the cytotoxicity of Montmorillonite was examined in two cell lines: primary murine spinal cord neurons and differentiated N1E-115 neuroblastoma cells. A clay suspension with a concentration of 0.1 mg/ml was added to the cultures. The neuronal cells were incubated for 1 h with Montmorillonite. Photomicrographs were taken at 5, 15, and 60 min following treatment. For the N1E-115 cells, incubation lasted 18 h and photomicrographs were taken at 5 and 15 min and 3, 6, and 18 h after the treatment. Morphological changes were observed using a phase-contrast microscope. Within 5 min, clay particles were observed on the neuronal cell bodies. Cell bodies appeared granular within 15 min. The cells were completely lysed after 60 min and there was no evidence of any remaining cell bodies or processes. Cell membrane contact was apparent after 5 min in N1E-115 cultures. No morphological changes were apparent at this point. At 18 h, the cells were covered with clay but cellular processes remained intact. N1E-115 cell lysis did not occur and no cytotoxicity was recorded.

Montmorillonite dust was tested for potential HLE-inhibiting effects (Oberson et al. 1996). HLE inhibition was evaluated by incubating 15 nM HLE for 1 h in the presence of 5 μg of Montmorillonite. Suc(Ala)₃pNA was then added for 30 min. Activity was measured at 410 nM. The 5 μg Montmorillonite (98% inhibition) abolished the activity of 0.45 μg HLE.

Pyrophyllite

The cytotoxicity of Pyrophyllite dust on rat alveolar macrophages was investigated in a study by Zhang, Zhang, and Song (1997). Cytotoxicity was measured by the potassium content of the macrophages and the levels of LDH. Alveolar macrophages were isolated from bronchi alveolar lavages of male Wistar rats. These animals were divided into six groups based on the dust concentrations. The groups were as follows: quartz (75.72 $\mu\text{g/ml}$) dust group; Pyrophyllite mine (PM) dust group A, 200 $\mu\text{g/ml}$ (75.72 $\mu\text{g/ml}$ SiO₂ and 30.42 $\mu\text{g/ml}$ Al₂O₃); PM dust group B, 200 $\mu\text{g/ml}$ (75.72 $\mu\text{g/ml}$ SiO₂ and 30.42 $\mu\text{g/ml}$ Al₂O₃); Pyrophyllite carving mills (PCM) dust group A, 200 $\mu\text{g/ml}$ (31.68 $\mu\text{g/ml}$ SiO₂ and 40.58 $\mu\text{g/ml}$ Al₂O₃); PCM dust group B, 200 $\mu\text{g/ml}$ (31.68 $\mu\text{g/ml}$ SiO₂ and 40.58 $\mu\text{g/ml}$ Al₂O₃); normal control of saline. Both PM group B and PCM group B were imitated groups of the natural dusts from the mines used to study the toxicity of SiO₂ and Al₂O₃. They did not include the metals Fe, Cu, Ni, and Zn as did both samples A. The cell cultures were incubated at 37°C for 16 and 22 h.

The LDH activity of quartz was greater than all other groups except PM group A incubated at 22 h. When compared to the saline controls, all exposed groups had significantly lower increases in LDH activity. Both the LDH activities of the PM dust groups were greater than those of the PCM dust groups ($p < .5$). However, no differences between the PM groups A and B or between the PCM groups A and B were detected. The K⁺ content of the saline controls was greater than all exposed groups. The quartz group had the lowest concentrations of K⁺ followed by the PM dust groups and then the PCM dust groups. Again, no differences between either A or B groups was observed. It was concluded that Pyrophyllite dust exposure is cytotoxic to alveolar macrophages and people working in a PM have greater risk of respiratory problems than people working on PCMs.

Mineralogical analysis of the dust samples taken from the mines was performed using an atomic absorption spectrophotometer. The SiO₂ content was 37.9% higher in the PM group than in the PCM group 15.8%. Al₂O₃ concentrations were lower in the PM dust groups (15.2%) than in the PCM dust groups (20.3%). Toxicity due to metals in the samples A was ruled out. The samples B did not include the metals and had similar LDH activity as the samples A (Zhang, Zhang, and Song 1997).

Zeolite (Zeolite A)

Zeolite A at concentrations of 0.1 to 100 $\mu\text{g/ml}$ was incubated for 48 h with normal human osteoblast-like cells. An induction of a dose-dependent increase in DNA synthesis and the proportion of cells in mitosis occurred. This mitogenic action was dependent on cell seeding density. Alkaline phosphatase activity and osteocalcin release were also increased but no significant effect on collagen production per cell occurred. Zeolite treatment increased the steady-state mRNA levels of transforming growth factor β (Keeting et al. 1992).

Zeolite (Clinoptilolite)

Total degradation of rat peritoneal macrophages incubated with Clinoptilolite dust particles occurred during 15- and 30-min time periods at concentrations of 1.0 and 0.5 mg/ml, respectively. Dust particles measured $<5 \mu\text{m}$. Thirty-eight percent of macrophages and 57.5% of RBCs were killed within 30 min at a Zeolite concentration of 0.25 mg/ml. Dose-dependent CL was observed in the first 10 to 20 s when luminol was added to the cultures. Catalase (30% to 50%) decreased the cytotoxic effects of Zeolite, whereas ethanol, sodium azide, and mannitol had no effect (Korkina et al. 1984).

Zeolite (Mordenite)

Syrian hamster and rat alveolar macrophages were exposed to nontoxic concentrations of Mordenite and the reduction of cytochrome *c* in the presence and absence of superoxide dismutase, and the amount of O_2 released were indicators of cytotoxicity. Other fibrous particles were used as positive controls. Mordenite as compared to the positive controls was less active at comparable concentrations (Hansen and Mossman 1987).

Zeolite (Nonfibrous Japanese Zeolite)

Japanese Nonfibrous Zeolite was incubated with two cell lines, Chinese hamster V79-4 and A579 at concentrations ranging from 5 to 100 $\mu\text{g/ml}$. Two samples of erionite and a sample of UICC crocidolite, a positive control, were also tested. Concentrations that inhibited plating were estimated using the LD_{50} . Compared to the positive control and the erionite samples, the Zeolite had a much greater LD_{50} value and was nontoxic in the A549 assay (Brown et al. 1980).

ANIMAL TOXICOLOGY

Acute Oral

Calcium Silicate

Calcium Silicate FDA compound 71-41 was suspended in 0.85% saline and administered to 10 male rats by intubation. Each animal that received a dose of 5000 mg/kg died within 24 h. Doses of 100, 500, 1000, 2000, 3000, and 4000 mg/kg were selected to determine the acute LD_{50} using the Litchfield-Wilcoxon method. Groups of 5 male rats were administered the doses and were killed for necropsy. The LD_{50} was determined as 3400 mg/kg; at the highest dose, necropsy findings included bloody gastric mucosa with distension, hydrothorax, and congested lungs. In a second LD_{50} assessment, Calcium Silicate was prepared as 24.1% (w/v) suspension and administered orally to a group of 10 male rats at a single dose of 5000 mg/kg. No signs of toxicity or abnormal behavior were observed within a 7-day period. No deaths occurred. All animals were killed and on necropsy no gross findings were observed. The acute oral LD_{50} was considered to be greater than 5000 mg/kg (Litton Bionetics, Inc. 1974).

Hectorite

Five male and five female Sprague-Dawley rats were administered a single dose of 5 g/kg of the test article by gavage. The animals were observed the day of dosing and 15 days after for gross and visible toxic or pharmacological effect. No such effects were seen and none of the animals died. All animals were killed for necropsy. No findings were reported. The acute oral LD_{50} was $>5.0 \text{ g/kg}$ of body weight (FDRL Inc. 1980b).

Kaolin

A report by the Federation of American Societies for Experimental Biology (1977) included an acute oral study in which 120 rats were fed doses of Kaolin ranging from 100 to 210 g/kg. Fourteen rats were controls. Kaolin was inert and nonstatic except for the danger of bowel obstruction resulting in perforation. The clinical signs were listlessness, anorexia, oliguria, hypothermia, and dyspnea. These were a pathological reaction from overdistension of the alimentary canal by an inert solid. The number of fatalities and the incidence and advance of bowel obstruction along the small intestine were dose related. The dose that killed 50% of the rats by bowel obstruction was 149 g/kg.

McClurg, Beck, and Powers (1980) fed a group of 10 male Sprague-Dawley rats a control diet plus 0.5 ml Kaolin 20%–pectin 1%. The control diet was then fed for 48 h and 72 h later stool samples were collected. The samples were analyzed for volume, sodium, potassium, and fat content. The results were 103% increase in sodium; 184% increase in potassium; fat excretion remained at baseline.

Magnesium Aluminum Silicate

Suspensions of 1 ml of Magnesium Aluminum Silicate at doses of 100–2000, 5000, 10000, 20000, and 50000 mg/kg were administered to a series of 37 mice. At the greatest dose, the mortality rate was 33%. The LD_{50} was considered to be $>50,000 \text{ mg/kg}$ (Munch 1944).

Zirconium Silicate

In a study conducted by Stookey et al. (1967), the LD_{50} of Zirconium Silicate was determined. Oral intubations of a 60% aqueous slurry of Zirconium Silicate containing 1% carboxymethylcellulose to prevent settling was given to 80 albino mice. Doses ranged from 70 to 200 gm/kg body weight. A dosage of 200 g of Zirconium Silicate per kilogram body weight was not sufficient to create a 50% mortality rate in mice. Dosages greater than 200 g were not tested due to the limitations of the mouse gastrointestinal tract. A 37.5% mortality rate was recorded for the dosage of 200 g/kg of body weight.

Short-Term Oral

Bentonite

Carson and Smith (1982) fed Bentonite at concentrations 0%, 2.5%, 7.5%, or 10% to male weanling rats to determine the most effective level to overcome the effects of T-2 toxicosis.

Increasing the concentration of Bentonite resulted in significant increases in body weight and feed consumption. The most effective concentration tested was 10%. Bentonite had no effect on the activity of nonspecific hepatic esterase.

The role of Bentonite in the prevention of T-2 toxicosis in rats was further investigated by Carson and Smith (1983). Groups of 10 male Wistar rats were fed diets containing 5% Bentonite for 2 weeks and the feed consumption and growth were recorded. Each diet was administered with or without 3 μ g T-2 toxin/g of feed for 2 weeks. Bentonite reduced the decreases in final body weight and feed consumption as compared to controls. The livers from this test group were excised and assayed for nonspecific esterase (E.C.3.1.1.1). Five percent Bentonite had no significant effect on the activity of this enzyme. In a second experiment, Bentonite was supplemented in the control diet at 2.5%, 5.0%, 7.5%, and 10%. Bentonite at 2.5% greatly increased feed consumption and final body weights and feeding. Ten percent Bentonite overcame the toxicosis completely. In a third study, rats were fed 0%, 5%, 7.5%, or 10% Bentonite for 2 weeks and then dosed with [3 H] T-2 toxin. The urine and feces were collected at 21 h and tissues were excised for determination of residual 3 H. Feeding Bentonite had little effect on the fraction of the dose excreted in the urine. Feeding 5%, 7.5%, and 10% Bentonite resulted in significant increases in the fecal excretion of 3 H when compared to controls. Bentonite had no effect on residual 3 H in the liver or kidneys but all concentrations reduced residual 3 H in muscle. Rats fed 5% Bentonite had more 3 H in the digesta in the small intestine and in the wall of the intestinal tissue when compared to controls. Intestinal transit time was reduced as well.

Bartko et al. (1983) fed a group of five sheep a diet containing 0.15 g/kg body weight of Zeolite for 3 months. Other sheep received no additions to their normal diet. At the end of the study, no difference in health effects was found between the two groups. The health effects included general behavior, total and acute acidity, content of volatile fatty acids in rumen contents, hematological values, content of microelements, transaminase activity, and acid-base homeostasis in the blood.

Magnesium Aluminum Silicate

Munch (1945) gave groups of 10 mice daily doses of either 5 or 10 g/kg of body weight orally for 10 days. Two days separated the first five doses from the second five doses. No signs were observed in any mouse at any time when administered 5 g/kg. The animals were killed and no pathological changes were seen at necropsy. No tissue was taken for further examination. One mouse died after five doses of 10 g/kg and one mouse died after nine doses of 10 g/kg. Neither mouse had lesions at postmortem examination.

This same author administered VEEGUM orally to 10 rabbits for a total of 10 doses. The first four animals were given 5 g/kg of body weight; the fifth animal was a control. The second four animals were given 10 g/kg of body weight; the fifth was also a control. No changes in body weight, no signs at toxicity, and no

deaths were recorded. All animals were killed and at necropsy no lesions were seen in the stomach, liver, kidneys, or other viscera. No tissue was taken for microscopic examination (Munch 1945).

Zeolite (Clinoptilolite)

In a 148-day feed-lot experiment reported by McCollum and Galyean (1983), 48 cross-bred steers were fed a 70% sorghum diet with Clinoptilolite substituted at 0%, 1.25%, and 2.5% of the diet dry matter. No differences were found among treatments in average daily weight gain, feed intake or feed efficiency.

Pond, Yen, and Crouse (1989) fed 32 castrated male pigs various diets of calcium, iron, and Clinoptilolite to study tissue storage of major and trace elements with the addition of Clinoptilolite. At day 84, all pigs were killed and analyzed. Dietary concentrations of calcium, iron, and Clinoptilolite had no effect on daily weight gain, daily feed intake, or the ratio of weight gain:feed intake of growing pigs.

Zeolite (Clinoptilolite and Sodium Zeolite A)

Weanling Landrace \times Yorkshire pigs were fed diets containing 3% Clinoptilolite with or without 150 ppm cadmium chloride or 3% Sodium Zeolite A with or without 150 ppm cadmium chloride for 31 days. Pigs fed cadmium and Zeolites did not have decreased hematocrit and hemoglobin values similar to those of pigs fed diets without the Zeolites. Hepatic cadmium concentration was significantly reduced in animals fed with Clinoptilolite. Hepatic iron was not affected significantly by either Zeolite; hepatic iron and zinc were decreased by dietary cadmium. Hepatic zinc was increased by Sodium Zeolite A (Pond and Yen 1983b).

Zeolite A

Various diets containing no Zeolite, 0.3% Zeolite A, or 0.5% Clinoptilolite were fed to cross-bred pigs for 6 weeks. The average daily weight gain, average daily feed intake, and feed:weight gain ratio were unaffected by supplementation of either Zeolite. Energy utilization was improved by feeding diets containing either Zeolite (Shurson et al. 1984).

Subchronic Oral

Magnesium Aluminum Silicate

The Food and Drug Research Laboratories (FDRL 1958a) carried out a 90-day feeding study using 220 weanling albino rats divided into five groups. The largest dose group consisted of 10 male and 10 female rats; control animals totaled 25 rats of each sex. A commercial ration was supplemented with 2%, 5%, 10%, and 20% VEEGUM. Control diets were unmodified. Body weight and feed intake were recorded daily and the efficiency of feed utilization (EFU; gram gained per 100 g) was calculated. Hematological examinations were made at 6 and 12 weeks on half of the test group. Blood sugar and nonprotein nitrogen determinations and urine analyses were also completed. Four rats in the 20% group, four rats in the 10% group, and control group

were placed on a modified program to estimate the balance between the intake of dietary ash and the ash excreted. Rats fed the 20% diet were examined at 8 weeks and rats fed the 10% diet at 12 weeks. All animals were killed at the end of the 90-day period. Liver, kidneys, spleen, heart, and adrenal glands weights were determined. Microscopic examination of the liver, kidneys, spleen, and portions of the gastrointestinal tract of four rats of each sex and control, 10%, and 20% groups were carried out.

The average body weights and net gains were not adversely affected by the ingestion of VEEGUM up to 10% in the diet. Growth was diminished slightly but with statistical significance ($p = .05$) when 20% VEEGUM was fed to both sexes. With EFU corrections, only the 20% dose significantly lowered the observed EFU value. One male rat of the 2% group died and one of each sex of the 10% group died. These rats had fibrinous exudates in the thorax, hemorrhagic lungs, and evidence of respiratory infection at necropsy. Gross findings for the rest of the animals revealed no significant abnormalities other than in the lungs. The incidences of pulmonary lesions did not differ among controls and test animals. Organ weights fell within normal limits. Hematological observations were within normal limits, including the rats of the 20% group. Blood sugar and nonprotein nitrogen values were also within normal limits. Females of the 20% group had slightly increased values compared to controls but still were in the normal range. Silicon content of the spleens of control animals were about the same as in the 2% group. However, in the 5% and 10% groups, the silicon content was slightly increased. Microscopic examination disclosed no abnormalities in the liver, kidneys, and gastrointestinal tract. Ash data indicated that 81% of VEEGUM of the 20% group was excreted and 73% of the 10% group was excreted (FDRL 1958a).

FDRL (1958b) fed two groups of four mongrel dogs, two female and two male for each group, a basal diet and a diet supplemented with 10% VEEGUM for 90 days. At 6 and 12 weeks, complete blood counts were made and blood sugar and nonprotein nitrogen were determined. Urine specimens were examined at 12 weeks for acidity, sugar, albumin, and microscopic elements in the sediment. At the end of 90 days, all dogs were killed for necropsy. Silicon content of the spleen was also determined. Body weight did not change despite a depression of appetite with the addition of VEEGUM. No abnormalities were seen upon hematological examination at the 6- or 12-week periods. Two of the test animals had slightly increased blood sugar at the end of the testing period. All other values for sugar and nonprotein nitrogen levels were normal. No difference in organ weight was seen. Silicon concentration of the spleens of the test animals were slightly elevated compared to controls (143 versus 103 mg/spleen). No microscopic lesions were compound induced.

CTFA (1999b) reported that in feeding tests with dogs and rats ingesting large amounts of VEEGUM (10% of ration) for 90 days, all responses were negative and VEEGUM was considered nontoxic.

Magnesium Trisilicate

Page, Heffner, and Frey (1941) gave six white rats daily doses of 0.6 g of Magnesium Trisilicate for 6 months. A litter was born and divided into two groups, a control and a treated group. The treated group received Magnesium Trisilicate doses from the time of weaning that corresponded to a daily dose of 3 or 4 pounds for a healthy human. This litter was also mated. Tissues from the animals of the first and second generation were examined microscopically. No evidence of tissue changes were recorded.

Dobbie and Smith (1982) gave six male guinea pigs a suspension in tap water of 250 mg/L Magnesium Trisilicate over a 4-month period for 5 days each week. Atomic absorption spectroscopy established that the soluble Si in the suspension was 267 $\mu\text{mol/L}$. Normal tap water was given to six control animals 7 days a week and 2 days a week to the test guinea pigs. At 4 months, all animals were killed for necropsy. The kidneys were processed for microscopic examination. All six animals had renal lesions that involved the distal nephron. Lesions of the distal tubule were dilation or cystic change. Some tubules were plugged with proteinaceous material. The interstitium of the kidneys was expanded by chronic inflammatory cells and excess collagen fibers. No lesions were seen in control animals.

Chronic Oral

Zeolite (Synthetic Zeolite A)

Groups of 50 male and female Wistar rats were fed 1, 10, 100, or 1000 mg/kg of Synthetic Zeolite A in their diets for up to 104 weeks. Clinical signs, mortality, and gross and microscopic lesions were recorded. No differences in body weight gain or clinical parameters were observed between control and treated animals. Based on feed intake, the Zeolite intake of the 10-, 100-, and 1000-mg/kg groups was 0.62, 6.1, and 58.5 mg/kg body weight/day for males and 0.65, 6.53, and 62.2 mg/kg body weight/day for females, respectively. No significant treatment-related lesions were observed in any of the organs examined and there was no effect on the types or incidence of any neoplastic changes seen (Gloxhuber et al. 1983).

Acute Parenteral

Aluminum Silicate

Musk et al. (1988) exposed Syrian golden hamsters to saline suspensions of Aluminum Silicate at 3.75 and 0.75 mg/100 g body weight by intratracheal instillation and sacrificed the animals at day 1. Their lungs were lavaged and the lavage fluid was characterized using cellular and biochemical indicators (lactic dehydrogenase, albumin, macrophages, polymorphs, and RBCs) of pulmonary damage. Either dose did not alter the biological parameters tested in comparison to those animals only exposed to saline.

Lemaire et al. (1989) gave Fiberfrax, an aluminum silicate, by intratracheal instillation at doses of 1, 5, and 10 mg to groups of

five rats. The details of this experiment are explained by Lemaire et al. (1989) under the Attapulgitte heading in this section. The average length of Fiberfrax fibers were 8.3 μm and <50% were under 5 μm . The significant inflammatory response was mainly numerous lymphocytes and epithelioid giant cells. The lesions were located predominantly around the terminal bronchioles. Areas of early fibrosis were seen in the lesions. Every test animal developed type C lesions, described above. A dose-dependent reaction was suggested due to more extensive lesions seen in animals dosed with 10 mg. The bronchoalveolar lavage fluid had macrophages as the predominant cells followed by neutrophils and then by lymphocytes.

Pigott and Ishmael (1992) studied the effects of intrapleural injections of Aluminum Silicate in rats. A single intrapleural injection of 20 mg of four Aluminum Silicate samples (Saffil, aged Saffil, aluminosilicates A and B) and chrysotile A asbestos was administered to dose and control groups consisting of 24 rats of each sex. The control group received only a saline injection. The predominant length of the fibers in each sample were Saffil, 10 to 20 μm ; aged Saffil, 20 to 40 μm ; aluminosilicate A, 20 to 40 μm ; and aluminosilicate B, 0 to 10 μm . Each rat was allowed to live out its lifespan or until it appeared distressed until 85% mortality was reached. All animals, were then killed and organs were taken for microscopic examination. Reactions to both forms of Saffil were very similar. In almost all animals, a minimal focal chronic pleurisy/fibrosis was minimal with adhesion formation. Pericardial adhesions and mesothelial proliferation with some Saffil fibers were seen. The reactions to both aluminosilicate samples were very similar. Minimal to moderate focal chronic pleurisy/fibrosis was often associated with mesothelial proliferation. Aluminosilicate B caused three malignant mesotheliomas, one pleural and two peritoneal. A benign testicular mesothelioma was seen in one rat dosed with Saffil, two dosed with aged Saffil, and four dosed with aluminosilicate A. Incidences of tumors are presented in Table 14.

Attapulgitte

Pott et al. (1987) injected three samples of 25 mg of Attapulgitte dust intraperitoneally into 40 Wistar rats. Electron microscopy of the sample revealed 37.5% of fibers <2 μm long and 70.0% <5 μm . All animals were observed until they died either spontaneously or were killed. Saline was injected into 80 control animals. The time required to produce the first tumor in the rats was 257 days and the tumor incidence rate was 65%.

Stanton et al. (1981) reported that two groups of 30 to 50 female Osbourne-Mendel rats received a single direct application to the left pleural surface by open thoracotomy of 40 mg of one of two Attapulgitte samples. The samples were 90% pure with quartz being the other component. One dose consisted of fibers >4 μm and the other contained no fibers >4 μm . The rats were killed at the end of 2 years. Pleural sarcomas were seen in 2/29 rats. The incidences of pleural sarcomas in the untreated groups were 3/491 and 17/615 of the rats receiving the pleural implants of Attapulgitte. Of rats receiving UICC crocidolite, 14/29 developed pleural mesotheliomas.

Be'gin et al. (1987) delivered Attapulgitte with a mean fiber length of 0.8 μm and diameter of 0.02 μm to the lungs of sheep by bronchoscopic cannulation. The tracheal lobe of 16 sheep was subjected to a single exposure of 100 mg of Attapulgitte in 100 ml of saline. A bronchoalveolar lavage (BAL) was conducted at 2, 12, 24, 40, and 60 days, and necropsy was conducted on day 60. Total BAL cells, macrophages, and neutrophils, fibronectin content, and LDH and β -GLUC activity were examined. Nine samples of the tracheal lobe of the lung were obtained each time for microscopic examination. The controls were saline-exposed sheep and had no changes in BAL or pulmonary morphology. The total BAL cells/ml and subpopulations increased significantly above control numbers at days 12, 24, and 40 but returned to control levels by day 60. Albumin and procollagen III did not differ from controls, whereas fibronectin, LDH, and β -GLUC activities were significantly above the controls. Microscopic examination revealed infiltrates that were predominantly alveolar and peribronchial lesions. Macrophagic alveolitis with minimal airway distortion was seen. Three sheep had lesions of peribronchiolar alveolitis.

Jaurand et al. (1987) injected samples (20 mg/ml of 0.9% NaCl) of Attapulgitte fibers with the median length of 0.77 μm into the pleural cavities of 36 2-month-old Sprague-Dawley rats. Two control groups, untreated and saline-injected, were utilized. Necropsy was performed after the rats died or killed when moribund. No mesothelial neoplasms were found in either controls or in rats treated with Attapulgitte. Survival times between the Attapulgitte-treated group and the controls were not statistically different.

Wagner, Griffiths, and Munday (1987) injected 20 male and 20 female, SPF Fischer rats intrapleurally with single injections of Attapulgitte. Three samples of Attapulgitte named after the location of their discovery (Lebrija, Torrejon, and Leichester) were utilized in this study. No concentrations were provided.

TABLE 14
Tumors in rats treated with intrapleural injections of four Aluminum Silicate samples (Pigott and Ishmael 1992)

Tumor	Control	Chry. Asbestos	Saffil	Saffil aged	Alumosil. A	Alumosil. B
Total no. of animals	62	81	71	68	57	67
No. of benign	44	55	57	56	46	49
No. of malignant	17	26	16	14	10	19
Malignant mesothelioma	0	7	0	0	0	3

TABLE 15
Toxic reactions to intrapleural injections of Attapulgitite
(Wagner, Griffiths, and Munday 1987)

Dust	Mesothelioma	Nonmesothelioma
Lebrija Attapulgitite	2	38
Torrejon Attapulgitite	14	26
Leichester Attapulgitite	30	2
Crocidolite	34	6
Kaolin	0	40
Saline	1	39

However, fiber length information was provided. Lebrija Attapulgitite had fiber lengths of $\leq 2 \mu\text{m}$. Torrejon Attapulgitite contained at the most 0.54% of fibers $\geq 6 \mu\text{m}$. Leichester Attapulgitite contained about 19% of fibers $\geq 6 \mu\text{m}$. The animals were allowed to live their life span but were killed if they appeared distressed. Upon death, necropsy and microscopic examination of tissue were performed. Dust extraction was obtained from granulomas removed from the diaphragm or mediastinal tissue. Two controls were used in this experiment; Kaolin and saline. One positive-control crocidolite was also used. The results from this experiment are summarized in Table 15.

Lebrija Attapulgitite dust extracted from the lung had fibers $\leq 2 \mu\text{m}$. Material examined from Torrejon Attapulgitite was fibrous and have fiber length up to $8 \mu\text{m}$. Leichester Attapulgitite fibers from extracted lungs were up to $25 \mu\text{m}$. The investigators considered these fibers to be tumorigenic. Kaolin was a nonfibrous dust and crocidolite was fibrous. The authors concluded that exposure to Torrejon, and Leichester Attapulgitite should be avoided (Wagner, Griffiths, and Munday 1987).

Lemaire et al. (1989) reported a study in which groups of five rats received single intratracheal instillations of Attapulgitite at 1, 5, and 10 mg. One month after treatment, BAL and microscopic examination of the lungs were performed. The average length of the fibers were $0.8 \mu\text{m}$ and 100% of the fibers were less than $3 \mu\text{m}$. Every test animal had type A lesions. Type A lesions are characterized by an accumulation of inflammatory cells mostly macrophages, and epithelioid cells around fiber deposits. These inflammatory cells form a compact cellular infiltrate at the periphery of the deposits and some are focally dispersed throughout the alveolar region. The BAL had mostly macrophages and a small number of neutrophils at 5- and 10-mg doses. At the 5-mg dose, 3.6% of the cells were lymphocytes.

In a study by Renier et al. (1989), intrapleural injections of 20 mg of different Attapulgitite fiber samples in 1 ml of saline were given to 2-month-old Sprague-Dawley rats. The control group received only a saline injection. All rats were allowed to live full life span. The mean length of Attapulgitite fibers in this experiment was $0.77 \mu\text{m}$. The number of groups were not reported; however, 36 rats were reported to comprise each group. Pulmonary and thoracic neoplasms were fixed and processed for histopathological examination. The survival time of the treated

groups (788 ± 155 days) was very similar to that of the control groups (809 ± 110 days). The incidence of mesothelioma was 0% for control groups and treated groups. Attapulgitite in the present experiment was not carcinogenic (Renier et al. 1989).

Lemaire (1991) reported a study in which groups of five animals received doses of 1, 5, or 10 mg of Attapulgitite by transtracheal injection to examine alveolar macrophage (AM) production of interleukin-1 (IL-1) and macrophages-derived growth factor (MDGF) from fibroblasts. Saline and UICC chrysotile B asbestos were used as controls. At 1 month, Attapulgitite produced granulomas and the UICC chrysotile B produced fibrosis. At 8 months, the granulomatous reactions had either resolved or were greatly diminished, whereas the fibrosis persisted. Cells obtained by BAL included multinucleated giant macrophages in animals treated with Attapulgitite, but not in those treated with UICC chrysotile B. Enhanced production of IL-1 was seen in all treated groups. MDGF production was only seen in animals with lung fibrosis.

Coffin, Cook, and Creason (1992) injected a single dose of 0.5, 2, 4, 8, 16, or 32 mg of Attapulgitite intrapleurally into six groups of 25 Fischer 344 rats. Nearly all the fibers were $< 1 \mu\text{m}$ in length. Mesotheliomas were present in 2/140 treated rats compared to 1/79 incidences in control groups. The median life span was 839 days for Attapulgitite-treated animals and 729 days for nontreated animals.

Bentonite

Sykes et al. (1982) investigated the effects of Bentonite dust administered by intratracheal instillation in rats. A 0.5-mg dose of Bentonite with a mean size of $0.3 \mu\text{m}$ was instilled intratracheally. Control animals were injected with sterile saline and TiO_2 (a nontoxic dust). Animals were killed at 1, 2, 6, 24, and 48 h; and 4 and 7 days after instillation. Bronchopulmonary lavage (BPL) was carried out and AMs and polymorphonuclear (PMN) leukocytes were recovered. The activity of LDH and protein content of the lavage fluid were also determined. In a second experiment, after instillation of 5 mg of Bentonite, the animals were killed at 1, 7, 49, and 100 days. In addition to the above, peroxidase and lysozyme activity were measured.

In the first experiment, a rapid influx of PMN leukocytes was detected at 6 h. PMN leukocyte response peaked at $\sim 19 \times 10^6$ cells after instillation and started declining more slowly up to 4 days. At 7 days, the PMN leukocyte numbers were 2.5×10^6 . The greatest increase in the numbers of AMs recovered occurred at 4 and 7 days. The mean diameter of macrophages increased from 11.0 to $12.5 \mu\text{m}$ over the first 48 h after instillation. The mean diameter decreased at 4 and 7 days. LDH activity at 24 h was maintained at 40 mU cm^{-3} and then increased (73 mU cm^{-3}) with the influx of PMN leukocytes into the lungs after 48 h. Protein concentration was calculated at $500 \mu\text{g cm}^{-3}$ for the first 24 h and was maintained for 48 h.

In the second experiment, large number of PMN leukocytes were recovered at day 1. However the severity of the response did not differ significantly from the 0.5 mg dose. By 7 days,

the numbers had decreased and was similar to control values. A significant decrease in the number of AMs compared to controls was observed at 24 h after instillation. This decrease was followed by a sharp increase that exceeded control values by 7 days. Total number estimates were similar to those of the first experiment. LDH activity and protein concentration from Bentonite and TiO₂ were very similar. The initial rise at day 1 following administration was short-lived. Peroxidase activity was minimal. Lysozyme activity rose sharply between 1 and 7 days, but returned to control values at 49 and 100 days (Sykes et al. 1982).

Marek and Blaha (1985) gave subplantar injections of 0.05 ml of a 5% solution of Bentonite to male Wistar rats. The rats either received both hind paw injections at an interval of 24 h or their left paw was injected with Bentonite and their right paw injected with 0.05 ml of a 10% solution of Kaolin. The injection was of Kaolin. Subcutaneous Bentonite granulomas were produced on the left side, both dorsally and ventrally. Simultaneously Kaolin granulomas were produced on the right side analogous to the Bentonite injection. Sodium salicylate and prednisone suppressed the Bentonite edema during the first 24 h. The presence of mononuclear cells was confirmed.

Tatrai et al. (1983) administered a single dose of 40 mg of Bentonite suspended in 1 ml of physiological saline containing 40,000 IU of crystalline penicillin intratracheally to male CFY rats. The Bentonite's composition consisted of 73% Montmorillonite, 18% cristobalite, 3% quartz, 3% feldspar, and 3% other minerals. Particle sizes were <2 μm. The control group received 1 ml of physiological saline containing 40,000 IU of crystalline penicillin. Animals were killed 12, 24, 48, or 72 h or 90 days after exposure. Body and lung weight of the rats were measured. The right lung was fixed and sectioned for microscopic examination. The lipids and phospholipids were analyzed in the left lung.

The body weights of the rats were moderately decreased and the lung weight increased 72 h after Bentonite exposure. After 90 days, the lung weight was only slightly greater than that of the control animals. Upon microscopic examination at 12 h, Bentonite exposure had resulted in a nonspecific inflammation of mostly neutrophils with perivascular edema, alveolitis, and incipient bronchopneumonia. A small number of macrophages and lymphocytes were detected. Dust particles were observed in the leukocytes and macrophages or extracellularly in the alveoli. After the 24th h, bronchopneumonia was present after coalescence of the inflammatory foci; the pneumonia then became necrotizing and desquamative. Necrotic neutrophilic leukocytes and eosinophil leukocytes were observed. The reticular network collapsed between the 48th and 72nd h. Exposure after 90 days, included dust storage foci filled with large foamy cells with pale cytoplasm. Closely packed cells with dark cytoplasm and nuclei were located at the periphery.

After 12 and 24 h, the amount of lipids and phospholipids in the lungs was not altered. However, between 48 and 72 h, the lipid and phospholipid content increase but distribution remained the same. After 90 days, the value was the same as seen at 72 h. (Tatrai et al. 1983).

Hatch et al. (1985) assessed the ability of Bentonite to increase susceptibility to bacterial pneumonia. Bentonite was injected intratracheally into mice at concentrations of 1, 10, and 100 μg. In vivo bacterial-infectivity screening assays were conducted by exposing the animals to aerosolized Group C *Streptococcus* species. The severity of infection was calculated by recording the deaths of the mice over a 15-day period. Control animals were exposed to TiO₂, a nontoxic dust. At the 100-μg dose, Bentonite increased the infectivity of the bacteria. Mortality was 85%. Even at 10 μg, Bentonite caused increased animal mortality (43.3%). Control dusts at 100 μg produced only a 5% mortality (Hatch et al. 1985).

In a study by Tatrai et al. (1985), male CFY rats were given a single dose of 60 mg of Bentonite, in 1 ml of physiological saline containing 40,000 IU crystalline penicillin, by the intratracheal route. Bentonite particle size was less than 5 μm. Control groups received 1 ml physiological saline containing 40,000 IU penicillin. Animals were killed at the end of 72 h, the 2nd and 4th week, and the 3rd, 6th, and 12th month. The acid phosphatase activity and the progression of fibrosis was determined. The lungs were processed for microscopic examination and fibrosis determined by Belt and King's classification. The results from this experiment are presented in Table 16. Acid phosphatase activity was increased at 72 h and had returned to normal by the first month.

Bentonite dust was administered intratracheally as a single 60-mg dose to Sprague-Dawley rats in a study by Adamis et al. (1986). The animals were killed 3, 6, and 12 months after exposure. The right lung was studied microscopically and the lipids, phospholipids, and hydroxyproline were determined. Significantly greater phospholipid values compared to controls were observed. Among the phospholipid fractions, the greatest quantitative increase was seen in phosphatidylcholine (more than twice the control) and the smallest increase was seen in phosphatidylethanolamine (less than 1.6 times). After 6 and 12 months, the values were similar. Lung lipids had a greater range of values than did the phospholipids (no details given). The wet weight of the lung in grams increased in 5% to 10% Bentonite-treated rats compared to controls at month 3. No

TABLE 16
Toxic effect of intratracheal instillation of Bentonite
(Tatrai et al. 1985)

End point	Time after instillation		
	72 hours	1st month	12th month
Acid phosphatase activity	72	—	—
Fibrosis	N/A	Loose reticulin fibrils, no collagen	Loose reticulin fibrils, no collagen

difference was detected at 6 and 12 months. Hydroxyproline content of treated rats (mg/g lung wet weight) was very similar to controls at 3, 6, and 12 months (Adamis et al. 1986).

Calcium Silicate

Bolton et al. (1986) injected three Calcium Silicate samples into the peritoneal cavity of three groups of 36 rats. Each rat was given a single injection of 25 mg of dust and allowed to live out their life span. At necropsy, little dust or dust-related fibrosis was visible in the peritoneal cavity. No mesotheliomas developed in any of the animals.

Richards, Tetley, and Hunt (1981) compared the biological reactivity of three samples of Calcium Silicate (A, B, and C) in vivo to that of chrysotile and titanium dioxide. Titanium dioxide and saline were considered negative controls, while chrysotile was considered a positive control. Groups of 32 female, MRC hooded rats were instilled intratracheally with 0.25, 0.50, 1.0, or 5.0 mg of Calcium Silicate. At weeks 1 and 4 after instillation, the control and treated rats were killed. The lungs were lavaged and the reactivity of the minerals to free cell populations, lavaged lung tissue, and pulmonary surfactant was conducted. All mineral doses of 5 mg induced an increase in the number of free cells at week 1. Only sample B increased in cell numbers at lower doses. At the end of 1 week, sample B was considered more reactive than either sample A or C, but chrysotile was considered more reactive than sample B. At 4 weeks, the effects seen from samples A and B are almost completely reversed and were comparable to that of titanium dioxide. Sample B at 4 weeks produced a greater or a comparable activity to chrysotile. No mineralogical analysis of the Calcium Silicate samples was provided.

Kaolin

Zaidi et al. (1981) investigated the effect of *Candida albicans* in modifying the fibrogenesis caused by Kaolin. Five groups of guinea pigs were injected intratracheally with *C. albicans* (500 μ g); Talc dust (75 mg); Talc and *C. albicans*; Kaolin (75 mg); or Kaolin and *C. albicans*. Two animals from each group were killed at 1, 7, 15, 30, 60, 90, 120, and 180 days after injection. The lungs were collected for bacteriological and microscopic examination. The combined effect of Kaolin and the organism incited an acute inflammatory reaction similar to Kaolin dust alone at day 1. However, Kaolin and the organism produced thick reticulin and collagenous fibrosis, unlike Kaolin alone. Talc produced only a thin reticulin fibrosis not enhanced by the presence of the organism. The enhanced fibrogenicity was attributed to the adjuvant activity of Kaolin with the polysaccharide glucan component of *C. albicans*.

Edwards et al. (1984) gave 12 fetal lambs and six fetal monkeys subarachnoid injections of Kaolin. A sterile suspension of 2% Kaolin in saline was injected into the cisterna magna. Fetal lambs received 1 to 3 ml of Kaolin and fetal rhesus monkeys received 0.5 to 1.0 ml. After injection the fetuses were replaced into the uterus. Prenatal ultrasound monitoring was used to document the progression of fetal ventriculomegaly. Cesarean

sections were scheduled for 140 to 145 days for the sheep and 160 to 165 days for monkeys. Newborn animals with gross head enlargement were killed 2 h after birth and necropsy was performed. Brains were sectioned for gross and microscopic examination. Five lambs and one monkey underwent ventriculoamniotic shunting at 120 days after gestation.

Ventricular dilatation was apparent at 1 week following Kaolin injections. The cerebral mantle was markedly thinned, with relative preservation of the cortex and severe attenuation of the white matter. The average cortical thickness of the cingulate gyrus in the Kaolin-injected sheep was 716 μ compared to 1225 μ in control animals. The corpus callosum was an average of 125 μ in thickness in the sheep compared to 475 μ in control animals. Microscopic examination of the cortical neurons were well preserved and contained the complexity and density of neural processes. A mild-to-moderate fibrotic reaction and inflammatory cell response along the basal meninges was apparent. A large number of macrophages containing Kaolin infiltrated the subarachnoid space. In five fetuses, Kaolin was injected mistakenly into either the epidural tissues superficial to the cisterna magna or into the cervical musculature. None of these fetuses had hydrocephalus at birth (Edwards et al. 1984).

Hatch et al. (1985) assessed the ability of Kaolin to increase susceptibility to bacterial pneumonia. Kaolin was injected intratracheally into mice at a dose of 100 μ g. In vivo bacterial-infectivity screening assays were conducted by exposing the animals to aerosolized Group C *Streptococcus* species. The severity of infection was calculated by recording the deaths of the mice over a 15-day period. Control animals were exposed to TiO₂, a nontoxic dust. A 100- μ g dose of Kaolin caused statistically significant but modest (<50%) increased death due to infection by a large dose. Mortality was calculated at 38.9%. Control dusts at 100 μ g produced only a 5% increase in mortality.

Wagner, Griffiths, and Munday (1987) used Kaolin as a negative control in a previous intrapleural injection study. The protocol and results are cited under Attapulgit in this section.

Fugiyoshi, Hayashi, and Oh-ishi (1989) reported a study in which Kaolin, a known activator of factor XII, was injected intraperitoneally into mice at 2.5 mg/mouse to study the Kaolin-induced writhing response. The writhing responses were observed in the 10 min after treatment and the mean number of responses was 9.2. Sixty minutes after the Kaolin injection, captopril (20 μ g/mouse) was injected and the writhing response was observed again for 10 min after injection. Captopril is an anti-hypertensive and vasodilator. A second study was conducted by administering bromelain (10 mg/kg intravenously) followed by the injection of Kaolin 30 min later. Bromelain is a standardized complex of proteases from the pineapple plant purported to have primarily antiedema, antiinflammatory, and coagulation-inhibiting effects. The response was not reproduced.

Montmorillonite

Heat-treated Montmorillonite in doses of 5, 15, and 45 mg was given to groups of four Sprague-Dawley rats by intratracheal

instillation. Following a 3-month postexposure period, the animals were killed and tissues were subjected to microscopic examination. The Montmorillonite particles were mainly restricted to alveoli within and adjacent to alveolar ducts regardless of dose. Most particles were contained within small to moderate numbers of pulmonary AMs. However, some particles were free in alveoli. Adjacent alveoli septae were mildly thickened. Interstitial fibrosis was present in all groups. At the 5- and 15-mg doses, fibrosis was mild to moderate, multifocal, and loose, meaning less collagen. The 45-mg dose produced dense fibrosis. Macrophages contained clay particles and lymphocytes were present in the lesions. Occasionally giant multinucleate cells were seen (Schreider, Culbertson, and Raabe 1985).

Zeolite

A single intratracheal administration of 50 mg of Zeolite dust was given to male rats and observations were made at 1 and 3 days, and 1 and 3 months after injection. Time-dependent increases in phagocytosis were observed. Morphological changes in the lungs was described as exogenous fibrous alveolitis (Kruglikov, Velichkovsky, and Garmash 1990).

Zeolite (Clinoptilolite)

Kruglikov et al. (1992) reported a study in which a single intratracheal instillation of 50 mg of Clinoptilolite was made to male rats. On days 1, 3 to 5, and 18 after injection, lung tissues were examined histopathologically. On the first day, the smallest Zeolite particles were phagocytized by neutrophils, whereas larger particles were phagocytized by macrophages. About a fourth of macrophages had phagocytized more than six dust particles per cell and <2% of macrophages were degenerated. At 3 to 5 days, no more particles were seen in neutrophils and their numbers had decreased. However, the percentage of macrophages containing more than six dust particles in the cytoplasm increased to 90%. Only 7% of macrophages degenerated. On day 18, the pattern of phagocytosis was similar to that at days 3 to 5, but 4% of macrophages were degenerated.

Tatrai and Ungv'ary (1993) instilled single intratracheal doses of 30 and 60 mg of Clinoptilolite particles to groups of 50 male and female (equal numbers) Wistar rats. The particles were <5 μm and were suspended in 40,000 IU crystalline penicillin. Controls received only saline instillations. All survivors were killed at the end of the study. Examination for gross and microscopic lesions were conducted. None of the treated groups had a significant increase in the incidence of any specific neoplasms compared to the controls. No positive trend was noted in the occurrence of neoplasms. Neoplasms seen within both control and treated animals were similar in the anatomical sites in which they were found and their histological feature.

Zeolite (Mordenite)

Suzuki (1982) gave two groups, one of 18 and one of 5 male Swiss albino mice, a single injection of 10 or 30 mg Zeolite intraperitoneally. The control animals were untreated. Ten

months after exposure, no neoplastic changes were observed in the treated animals. Nearly all (98%) of the sample particles were <5 μm .

Suzuki and Kohyama (1984) administered a single injection of 10 mg of Mordenite to a group of 50 male BALB/c mice. The control animals received saline injections. The Mordenite sample was comprised of 94% of particles <3 μm . No peritoneal tumors were observed in any of the control animals. Mild peritoneal fibrosis was seen in treated mice, but no peritoneal or any other organ neoplasms were observed between 7 to 23 months.

Tatrai, Wojn'arovits, and Ungv'ary (1991) made intratracheal instillations of 60 mg of Mordenite to groups of 10 rats. The animals were killed at 1 week, and 1, 3, 6, and 12 months after exposure. Lesions in the lungs were observed. Nonspecific confluent bronchopneumonia was observed at 1 week after exposure and sequestration of macrophages at 1 month after exposure. Mild fibrosis was observed at later times. After 12 months, the aluminum:silicon ratio in macrophages was similar to the ratio in natural Zeolites.

Tatrai et al. (1992) reported the changes in cervical and hilar lymph nodes in the test animals treated in the above study as seen by electron microscopy and light microscopy. By the end of the first year, dust storing macrophage foci developed in the lymph nodes with minimal fibrosis. Also 3/10 of the rats had atypical hyperplasia. Electron microscopy showed the dust stored in macrophages without structural changes. However, dispersive x-ray microanalysis of the intracellularly stored dust revealed the ratio of the two main elements, aluminum and silicon, changed with respect to aluminum as compared to the original Zeolite sample.

Zeolite (Nonfibrous Japanese Zeolite)

A single intrapleural injection of 20 mg of Nonfibrous Japanese Zeolite was administered to two groups of 20 male and 20 female Fischer 344 rats. Control rats received saline injections alone. Mean survival time for control animals was 720 days and 715 days for treated animals. One pleural mesothelioma was found in the control group and one pleural and one peritoneal mesothelioma was found in the treated group (Wagner et al. 1985).

Zeolite (Synthetic Zeolite 4A)

A single intraperitoneal injection of 10 mg of Synthetic Zeolite 4A was given to groups of 50 male BALB/c mice. The average particle length of the sample was 2.24 μm . Treated animals were observed for 7 to 23 months after exposure and no mesothelioma were observed (Suzuki and Kohyama 1984).

Zeolite (Synthetic Zeolite MS4A and MS5A)

Maltoni and Minardi (1988) reported a study in which groups of 20 male and 20 female Sprague-Dawley rats received a single intraperitoneal injection of 25 mg of Zeolite MS4A (sodium aluminum silicate) or MS5A (calcium aluminum silicate) or water

only (control). Observations were made for the animal's entire life span and microscopic examination was performed. One peritoneal mesothelioma in an Zeolite MS4A-exposed rat was found at 141 weeks after treatment.

These same authors administered single intrapleural injections and single subcutaneous injections of 25 mg of Zeolite MS4A and MS5A or water to separate groups of 20 male and 20 female Sprague-Dawley rats. No difference in incidences of tumors was found among control and treated animals (Maltoni and Minardi 1988).

Zirconium Silicate

In a study by Harding (1948), a 3-ml dose of a 10% suspension of Zircon in milk and saline was injected intraperitoneally into three cavies (guinea piglike rodent). The animals were killed nearly a year later. At microscopic examination, a dry opaque material was embedded in the peritoneum of the abdominal wall over the small intestine, and in the omentum. Growth was not affected.

The accumulation of Zirconium Silicate in tissue was reported by Stookey et al. (1967). In one study, six young adult male rats were anesthetized and were given subcutaneous injections into their back. Half of the rats were injected with saline to serve as controls and the other half were injected with 0.3 ml of an aqueous 50% slurry of Zirconium Silicate. Three weeks after the injections, the animals were killed. Tissue surrounding the injection site was excised and prepared for microscopic examination. Zirconium Silicate deposits were observed as discrete nodules with a narrow surrounding connective tissue wall in the deep connective tissues of the back. Saline controls had no lesions and in some cases, healing was complete.

In another study in this report, eight young adult female rats were divided into four equal groups according to body weight and their tissues were subjected to microscopic examination following saline and Zirconium Silicate or sodium zirconium

lactate injections. Group 1, the control group, was given a single injection of 0.05 ml of isotonic saline in four different areas: subcutaneous injections in the right buccal mandibular mucosa; periosteal injections in the left buccal mandibular periosteum; intramuscular injections on the ventral side of the left thigh; subcutaneous injections in a shaved area on the back located about 1 inch behind the shoulders of the midline. Group 2 was similarly injected with 0.05 ml of a 20% slurry of Zirconium Silicate. Groups 3 and 4 were injected with 0.05 ml of a 20% solution of sodium zirconium lactate and a 20% slurry of flour of pumice. All animals were killed 1 week after the injections and tissue samples for histological sections were taken at each injection site. An identical study with the same experimental procedures as the above study used adult male guinea pigs. In each species, saline injections produced no effect, Zirconium Silicate caused minimal toxicity, and sodium zirconium lactate plus pumice was toxic. The results from these two studies are listed in Table 17.

The results pertain to both the rat and guinea pig studies. Zirconium Silicate deposits were described as well circumscribed masses of particulate material surrounded by a narrow zone of new connective tissue. Nonspecific muscle damage, without necrosis due to the presence of the particulate matter and the volume of injected material, was localized to the immediate vicinity of the injection site. Macrophages along a border of a mass of Zirconium Silicate had reflective material within their cytoplasm. Dispersed particles were phagocytized by macrophages, with little or no associated inflammatory response. No evidence of bone resorption was found adjacent to periosteal deposits.

In another study by these authors, skin and muscle tissue samples were taken for microscopic examination. Eight adult rats were anesthetized and a deep incision was made on the ventral side of the left rear leg. The incision was made in the quadratus femoris muscle. The animals were exposed to 50 mg of pumice flour, silica dioxide, and Zirconium Silicate, respectively. Insertion of the appropriate substance was made into the muscle

TABLE 17
Toxic reactions to injected Zirconium Silicate (Stookey et al. 1967)

Animal species	Agent injected	Concentration (%)	Degree* of tissue reaction			
			Oral mucosa	Subcutaneous tissues	Periosteal tissue	Intramuscular tissue
Rat	Saline		0	0	0	0
Rat	Zirconium Silicate	20	+	+	0	+
Rat	Sodium zirconium lactate and pumice	45 and 20	+++	+++	+++	+++
Guinea pig	Saline		0	0	0	0
Guinea pig	Zirconium Silicate	20	+	+	+	+
Guinea pig	Sodium zirconium lactate and pumice	45 and 20	+++	+++	+++	+++

*0 = reaction absent.
+ = mild inflammatory reaction of little consequence.
++ = mild reaction with granulomatous response.
+++ = destructive granulomatous reaction.

TABLE 18
Toxic reactions to implantation of Zirconium Silicate
in muscle tissue (Stookey et al. 1967)

Agent embedded in muscle	Amount (mg)	Degree of tissue reaction*	
		Subcutaneous tissue	Intramuscular tissue
Pumice	50.0	+	+
Silica dioxide	50.0	++	+++
Zirconium Silicate	50.0	+	+
Control		0	0

*0 = reaction absent.

+ = mild inflammatory reaction of little consequence.

++ = mild reaction with granulomatous response.

+++ = destructive granulomatous reaction.

incision and into the skin 1 cm lateral to the muscle incision. Control animals had the same muscle incision, but no foreign material was inserted. One animal from each group was sacrificed 10 days following surgery. The remaining animals were sacrificed 30 days from the incision. All tissue was fixed and prepared for microscopic examination. Table 18 presents the data from this experiment.

Adjacent tissues were free of inflammation or evidence of injury at 10 and 30 days. Deposits of Zirconium Silicate were identified and were surrounded by a narrow zone of new connective tissue. No necrosis was identified (Stookey et al. 1967).

Short-Term Parenteral

Attapulgit

Pott et al. (1987) conducted a study in which three samples of Attapulgit labeled Georgia, Lebrija, and Morimoiron were injected intraperitoneally to study their carcinogenic effects in rats. Each sample was injected one time each week for 9 weeks at 60 mg per injection. The number of female Wistar rats for each of the samples (Georgia, Lebrija, and Morimoiron) was 112, 115, and 114, respectively. Fiber analysis was made

of each of the samples Morimoiron, Georgia, and Lebrija. The <50% fiber length was 0.7, 0.5, and 0.8 μm , respectively, and a <50% fiber diameter of 0.07, 0.07, and 0.04 μm , respectively. Some rats died spontaneously or others in poor health were killed. Surviving animals were killed 2.5 years after treatment for necropsy. At necropsy, neoplasms or organs with suspected neoplasm tissue were fixed for microscopic examination. These three samples were noncarcinogenic. The results are presented in Table 19.

In another experiment by the same investigators, a fourth sample of Attapulgit from Caceres was tested. Intraperitoneal injections of 2, 4, and 4 mg were administered consecutively for 3 weeks. The fiber length and diameter of this sample were <50% 1.3 and 0.07 μm , respectively. Animals in poor health were killed. Surviving animals were killed 2.5 years after treatment for necropsy. At postmortem examination, parts of neoplasms or organs with suspected neoplasm tissue were fixed for microscopic examination. The results were considered moderate in relation to the dose. The Caceres Attapulgit sample results are also presented in Table 19 (Pott et al. 1987).

Kaolin

Toxicity of some of the minerals present in coal-mine dust was examined by Martin, Daniel, and Le Bouffant (1975). Five hundred female SPF Sprague-Dawley rats were divided into groups each with 10 animals. The rats were exposed over a period of 3 months to 50-mg/rat intratracheal instillations of Kaolin. The following assessments were made: weight of the fresh lungs; macroscopic and microscopic lesions in the lungs; amount of collagen and dust present in the lungs; and calculation of the toxicity index from the amount of collagen formed per mg of dust. The weight of fresh lungs subjected to Kaolin was 1.76 g. Collagen formed per lung was 23.9 mg. The dust per lung was 30.2 mg and the collagen/dust ratio was 0.79. Microscopic examinations of the lungs showed no alveolar proteinosis but Kaolin was detected in the bronchiolovascular lymphoid sheaths. No information regarding nonexposed lungs was presented. The opinion of the investigators was that exposure to

TABLE 19
Carcinogenic effect of intraperitoneal injection of Attapulgit from four sources (Pott et al. 1987)

Attapulgit sample source	No. of rats	% of rats with tumors	Lifespan (weeks) after treatment of					
			All rats			Rat with tumors		
			Time to death for <20% of all rats	Time to death for <50% of all rats	Time to death for <80% of all rats	All rats dead by this time	Time to death of first rat with tumor	Average time to death of rats with tumors
Mormoiron	114	3.5	92	116	138	164	47	92
Lebrija	115	3.5	95	116	134	164	98	114
Georgia	112	3.6	89	108	129	163	75	100
Caceres	30	40.0	94	109	132	142	74	116

Kaolin results in "pulmonary toxicity" and possesses "fibrogenic capacity" (Martin, Daniel, and Le Bouffant 1975).

Magnesium Silicate

An emulsion of Magnesium Silicate, 500 mg in 1 ml of saline, was injected subcutaneously into groups of 10 female Wistar rats once daily at 2, 4, 6, 13, or 20 days. As controls, 12 nontreatment rats were killed on the first experimental day and 12 rats were injected with 1 ml of saline once daily for 20 days. The trabecular bone, sinusoids, and hematopoietic cells were processed for microscopic examination. No significant change in the volume percentage of hematopoietic cells, sinusoids, or trabecular bone was present in the day-2 treatment group. After 4 days of treatment, the volume percentage of hematopoietic cells increased rapidly, sinusoids decreased rapidly, and trabecular bone decreased gradually. The volume percentage of hematopoietic cells was about 2.6 times normal, and that of sinusoids and trabecular bone was about 30% and 60% of normal, respectively, after 20 days of treatment. The tibia metaphyses had the following changes after 4, 6, 13, and 20 days of treatment; sinusoids were compressed by the markedly proliferated myelocytic element and severely narrowed the distance between the sinusoidal wall and the surface of trabecular bone was markedly increased. Atrophy of the thin trabecular bone was seen but no significant changes in osteocytes, osteoblasts, or osteoclasts were seen (Shibayama, Nishioto, and Nakata 1993).

Zeolite (Clinoptilolite)

Three intrapleural injections of 20 mg of Clinoptilolite were given in monthly increments to a group of 44 male and 49 female rats. Control animals received only saline injections. The Zeolite sample was described as having the formula: $(\text{Na},\text{K})\text{Ca}[\text{Al}_6\text{Si}_{30}\text{O}_{72}] \cdot 20\text{H}_2\text{O}$, with Cu, Pb, Zn, Ni, Co, Mo, Mn, Ti, Sr, Ba, and Hg contamination. Particle size measurements were recorded as follows: $<3 \mu\text{m}$, 6.5%; $5 \mu\text{m}$, 5.9%; $10 \mu\text{m}$, 5.9%; $10\text{--}30 \mu\text{m}$, 20.6%; $30\text{--}100 \mu\text{m}$, 35.1%; $100\text{--}500 \mu\text{m}$, 26.1%. Pulmonary lymphosarcomas, pleural and abdominal lymphosarcomas, and lymphatic leukemias were observed in 47/93 treated animals and 5/45 saline-treated animals. No mesothelioma or pulmonary neoplasms were observed in the controls. Mesothelioma and bronchial carcinoma were detected in 2/93 and 1/93 treated animals, respectively (Pylev et al. 1986).

Zeolite (Phillipsite)

Three intrapleural injections of 20 mg of Phillipsite given in monthly increments were administered to a group of 44 male and 49 female rats. Control animals received only saline injections. The Zeolite sample was described as having the formula: $(\text{Na}_{1.38}\text{K}_{0.53}\text{Ca}_{0.87}\text{Mg}_{0.25})(\text{Si}_{11.93}\text{Al}_{4.03}\text{O}_{32}) \cdot 9\text{H}_2\text{O}$. Particle size measurements were recorded as follows: $<5 \mu\text{m}$, 14.5%; $10\text{--}30 \mu\text{m}$, 32.8%; $50\text{--}70 \mu\text{m}$, 16%; $\geq 100 \mu\text{m}$, 36.7%. Neoplasms were found in 41/101 Zeolite-treated rats (50 tumors).

Tumor types included 1 pleural mesothelioma, 2 pulmonary adenocarcinoma, 29 hemoblastosis, 7 mammary gland neoplasms, and 11 neoplasms found at other sites. In control animals, 16 neoplasms (pulmonary, pleural, and abdominal lymphosarcomas, lymphocytic leukemias, and mammary gland neoplasms) were identified in 14/52 rats (Pylev et al. 1986).

Zirconium Silicate

Harding (1948) reported results when an adult rabbit received intravenously four doses over 1 week of a 5-ml suspension of a 10% solution of Zircon. The animal was killed 33 weeks later. At microscopic examination revealed small clumps of crystals were close to the portal tracts of the liver. The clumps were in the Kupfer cells. Fibrosis was detected. Small clumps of crystals were also observed in the spleen and alveolar walls and spaces of the lungs.

In another study in this report, six young rats were injected intratracheally with 1 ml of a 10% solution of Zircon. Three rats were killed after 7 and 9 months. The lungs were radiographed and sectioned for microscopic examination. Much of the material was found free within the alveoli and lymph vessels of the lungs. A small amount was found within phagocytic cells. Swollen histiocytes were seen in a few alveoli. Fibrosis was not evident (Harding 1948).

Inhalation

Attapulgit

Wagner, Griffiths, and Munday (1987) exposed 40 (20 male and 20 female) SPF Fischer rats to Attapulgit dust in an inhalation chamber. The rats were exposed to two samples of Attapulgit (named by the region in which they were mined, Lebrija and Leichester) at a concentration of 10 mg/m^3 for 6 h/day for 5 day/week until they were killed. At 3, 6, and 12 months, four animals were killed. All remaining rats were allowed to live their life span. All animals were subject to necropsy; the lungs, liver, spleen, kidneys, and other relevant organs were examined microscopically. Mineralogical analysis, examination of ashed lung sections and examination of macerated lung tissue, were also performed. Kaolin, the negative-control dust, and Crocidolite UICC, the positive-control dust, were also administered at a dose of 10 mg/m^3 .

At microscopic examination, one peritoneal mesothelioma, one adenocarcinoma, and three bronchoalveolar hyperplasia were found in rats treated with Lebrija Attapulgit. Thirty-five rats had no proliferative changes. In rats treated with Leichester Attapulgit, proliferative lesions observed included two mesothelioma, one peritoneal mesothelioma, one malignant alveolar neoplasm, two benign alveolar neoplasms, and eight bronchoalveolar hyperplasias. Twenty-seven rats had no proliferative lesions. Rats exposed to the negative-control Kaolin had two bronchoalveolar tumors. Rats in the positive-control Crocidolite group had one adenocarcinoma and three bronchoalveolar tumors. The mean fibrosis grades of each treatment group are presented in Table 20.

TABLE 20
Toxicity of inhaled Attapulgit dust (Wagner, Griffiths, and Munday 1987)

Dust source	Total no. of rats	Mean fibrosis grade as function of time after exposure			
		3 months	6 months	12 months	24 months
Lebrija Attapulgit	40	3.1	2.6	3.2	3.2
Leichester Attapulgit	40	3.0	3.1	4.0	—
Kaolin	40	2.8	2.75	2.4	2.1
Crocidolite UICC	40	4.1	3.3	3.1	3.8

The classification of proliferative lesions and neoplasms corresponding to the mean fibrosis grades are as follows: (1) bronchoalveolar hyperplasia—no malignant proliferation of the epithelia; (2) benign alveolar neoplasm; (3) malignant alveolar neoplasm; (4) adenocarcinoma; (5) squamous carcinoma; (6) adenosquamous carcinoma; and (7) mesothelioma.

The Lebrija Attapulgit dust extracted from the animal lungs did not have short fibers and the presence of granular material and long fibers. The Leichester Attapulgit dust also had the presence of long fibers. Kaolin is a nonfibrous dust. UICC Crocidolite is a fibrous dust but lengths were not published in this study (Wagner, Griffiths, and Munday 1987).

Calcium Silicate

Bolton et al. (1986) exposed white male Wistar rats to clouds of Calcium Silicate dust at a concentration of 10 mg/m³ for 7 h/day, 5 days/week, for a total of 224 days over an elapsed period of 12 calendar months. A total of four inhalation chambers were used with 48 animals/chamber. One chamber was reserved for control animals receiving only filtered air. The remaining three chambers were used to test three samples (A, B, and C) of Calcium Silicate. Twelve rats were killed from each of the chambers at the end of the dusting period. The final surviving animals were killed at the end of 19 months after exposure. At necropsy, tissue samples and one lung were taken from all major organs for microscopic examination. The other lung was taken for lung-dust analysis. The lung was dried and prepared for infrared analysis. Blood samples were taken 5 days prior to the start of the exposure and 3 days after the exposure.

All Calcium Silicate-treated groups had dust-containing macrophages scattered throughout the alveolar regions of the lung at the end of the exposure period. Occasional fibers were seen in animals with exposure to the Calcium Silicate 3. The frequency of dust-containing macrophages declined at the end of the dust exposure. Fewer dust-containing cells were in animals exposed to samples C than A or B. The number of animals with interstitial fibrosis for samples A, B, C, and controls were three, five, five, and five, respectively. In all cases, the alveolar septa were thickened with abnormal deposits of reticulin and in old animals with collagen. Although most cells were relatively flat in some areas, some cells were cuboidal and had the appearance of adenomatosis. Peribronchiolar fibrotic areas were close to the

respiratory bronchioles and small granulomatous nodules with macrophages and fibroblasts were seen in rats exposed to sample A. Mediastinal lymph nodes from all treated animals showed no particulate material at the end of exposure. Small primary neoplastic lesions were found in two animals exposed to sample B. One lesion was described as a small squamous cell carcinoma and the other as an adenoma. No pathological changes were observed in all other organs. All examined blood parameters were within normal ranges for both animals studied before and after exposure (Bolton et al. 1986).

Kaolin

Kaolin was used as a negative control in a previous inhalation study. The protocol and results are cited under Attapulgit in this section (Wagner, Griffiths, and Munday 1987).

Zeolite (Synthetic Zeolite A)

A group of 15 male and 15 female Wistar rats were exposed to 20 mg/m³ of Synthetic Zeolite A for 5 h/day, three times a week for 22 months. The Zeolite was characterized by (Na₁₂(Al)₂)(SiO₂)₁₂·27H₂O and consisted of particles ranging from 0.5 to 10 μm. Thirty untreated males were the control group. Histopathological examinations of the trachea and the lung were completed. Moderate to extensive respiratory disease was seen in treated and control groups. No neoplasms were observed in any group (Gloxhuber et al. 1983).

In another study by Gloxhuber et al. (1983), a chronic inhalation study of Zeolite A batch F 325 dust was conducted. Groups of 15 male and 15 female hamsters and 15 male and 15 female rats were exposed for 5-h periods three times a week for 12 months for hamsters and 22 months for rats. Control animals were exposed to untreated air. The trachea and lungs of the animals were examined microscopically. Microscopic examination was limited to the trachea and lungs of 10 treated hamsters and 8 controls and to 10 treated rats and 5 controls due to deaths caused by a specific infection. Both species had moderate signs of respiratory disease in the treated and controls. In Zeolite-exposed hamsters, macrophages with accumulations of foreign material were found, mainly in alveoli. No other lesions of inflammation or connective tissue reactions were seen. Rat lungs had grey-white deposits in macrophages of the alveoli and the peribronchiolar lymph nodes near the hilus. Isolated

clay deposits were found in the mediastinal lymph nodes but no reactions were seen about the deposits.

Zeolite (Synthetic Nonfibrous Zeolite)

Groups of 20 male and 20 female Fischer 344 rats were exposed in inhalation chambers to a mean respirable dust concentration of 0 or 10 mg/m³ of a Synthetic Nonfibrous Zeolite. Exposures were for 7 h/day, five days/week for 12 months. All animals were observed for their life span. Three males and three females per group were killed at 3, 6, 12, and 24 months after exposure. Erionite and UICC crocidolite were used as positive controls. The mean survival time for animals exposed to the Zeolite was 797 days, 504 days for animals exposed to erionite, 718 days for animals exposed to UICC crocidolite, and 738 days for untreated animals. One pleural mesothelioma and one pulmonary adenocarcinoma were seen in Zeolite-exposed rats. No neoplasms were found in controls; 27 mesotheliomas were found in erionite-treated rats and 1 squamous-cell carcinoma of the lungs was found in UICC crocidolite-treated rats (Wagner et al. 1985).

Dermal Irritation

Hectorite

A primary irritation study patterned after the Draize method was conducted using six white rabbits. Either a 0.5-ml or a 0.5-g sample of Hectorite was applied to two sites, one on abraded skin, and the other on intact skin of the backs of the rabbits. The test sites were occluded for 24 h. At the end of the 24 h, the binders were removed and the sites were gently wiped clean. One-half hour later, the sites were examined and scored for erythema and edema. The sites were examined again at 72 h. The average score was 0.0 and the test subject was nonirritating to the skin of rabbits (FDRL Inc. 1980a).

Magnesium Aluminum Silicate

VEEGUM (2 g) was applied daily to the external ears of four rabbits for 10 days. These applications were made to both abraded and intact skin. The abraded skin healed completely within 4 to 6 days after application. No gross effects were noted in any of the animals. No tissue was taken for microscopic examination (Munch 1944).

VEEGUM was applied to the closely clipped intact and abraded abdominal skin of two groups of four rabbits each. A nonabsorbent paper binder was placed onto the treated area. The dose was 3.4 g/kg of body weight. After 24 h, the binder was removed and any residual test material was removed by washing. Dermal irritation was recorded at 24 h and once daily after application for 7 days. All the animals were killed and necropsy was performed. No deaths and no systemic toxicity occurred from percutaneous absorption. The acute dermal LD₅₀ was >3.5 g/kg of body weight. Dermal irritation generally consisted of moderate erythema and slight edema. The edema completely subsided within an additional 24 h, and erythema completely subsided in

all animals between days 2 and 4. No major necropsy findings were reported (Hazelton Laboratories, Inc. 1968).

Eight male white rabbits were used in a primary skin irritation test with a solution of 4% MAS; 0.3 ml of the test substance was applied to the intact and abraded skin of the backs of four rabbits. The test substance was applied under occlusive patches for 24 h. The plaster was removed 24 h after application and the skin reactions were evaluated at 24 and 72 h. The primary irritation index was 0.1, suggesting that Magnesium Aluminum Silicate is a weak primary skin irritant (CTFA 1970a).

Three male guinea pigs were used in a cumulative skin irritation test with a solution of 4% MAS (in deionized water). The test substance (0.05) was applied to the flank of the animals once daily for 3 consecutive days. Skin reactions were evaluated at 24 h after each application. The cumulative irritation index was 0.0 and MAS had no cumulative skin irritation under the test conditions (CTFA 1970a).

Sodium Magnesium Silicate

CTFA (1970b) reported a study in which eight male, white rabbits were used in a primary skin irritation test with a solution of 4% Sodium Magnesium Silicate (in deionized water). The test substance (0.3 ml) was applied to the intact and the abraded skin on the backs of four rabbits. The test substance was applied under occlusive patches for 24 h. The plaster was removed 24 h after application and the skin reactions were evaluated at 24 and 72 h. The primary irritation index was 0.0, suggesting that Sodium Magnesium Silicate has no primary skin irritation under these test conditions.

CTFA (1970b) reported that three male guinea pigs were used in a cumulative skin irritation test with a solution of 4% Sodium Magnesium Silicate (in deionized water). The test substance (0.05 ml) was applied the flank of the animals once daily for 3 consecutive days. Skin reactions were evaluated at 24 h after each application. The cumulative irritation index was 0.0 and Sodium Magnesium Silicate had no cumulative skin irritation under the test conditions.

Ocular and Mucosal Irritation

Bentonite

Preparations of Prophypaste, Bentonite, tragacanth, trypsin, and sterile water were injected either intralamellarly or directly into the anterior chamber of six adult New Zealand rabbits at concentrations ranging from 1 to 5 mg/ml. No significant reactions were recorded with sterile water, Prophypaste, tragacanth, or combinations of tragacanth and Bentonite. Bentonite caused severe iritis after injection into the anterior chamber, but no corneal or retrocorneal reaction was noted grossly or microscopically. In five of the eyes where Bentonite was injected intralamellarly, widespread corneal infiltrates and retrocorneal membranes were observed within 2 to 5 days. The sixth eye had no reaction, only 0.1 ml of 0.25 mg/ml was injected. Anterior chamber taps of the eyes showed viscous mucopurulent material. Microscopic sections showed pseudoeosinophils, retrocorneal membranes,

and fibrovascular membranes in the anterior segment. Polarized light revealed highly birefringent particles were found at the injection sites, but not in the retrocorneal masses (Austin and Doughman 1980).

Hectorite

A primary eye irritation study using nine New Zealand white rabbits was carried out according to the Wolcott Procedure. A 0.1-ml liquid or semisolid (100 mg of the solid) sample was instilled into the one eye of each rabbit. Six of the nine animals' eyes were not rinsed and the eyes of three of the animals were rinsed approximately 4 s. All untreated eyes served as controls. The eyes were then examined with sodium fluorescein and an ultraviolet lamp at 24, 48, and 72 h and at 7 days. The mean score at 24 h was 2.0. All subsequent scores were 0.0. The test sample was considered moderately irritating to rabbit eyes without rinsing and practically nonirritating to the eyes with rinsing 4 s after instillation (FDRL Inc. 1981).

Magnesium Aluminum Silicate

Hazleton Laboratories, Inc. (1968) made a single application of 100 mg of VEEGUM or 0.1 ml of a 50% weight/volume to rabbit eyes. An aqueous suspension was made into the conjunctival sac of the left eye of each of six (undiluted) and three (50% suspension) rabbits. Three eyes (undiluted) were washed for 4 s after application and the remaining six eyes were not irrigated but held closed for 1 s. Control rabbits were not treated. Observations were made at 1, 4, 24, 48, and 72 h and at 4 and 7 days following application. Irritation was graded according to the Draize system. On day 7, the eyes were treated with 2% sodium fluorescein stain to provide evidence of corneal damage. Irritation generally consisted of moderate conjunctival hyperemia in all eyes and slight iritis in five of the eyes (one in the nonirrigated, undiluted group and two in each of the other groups). In the nonirrigated eye treated with the dry material, the iritis persisted until 72 h, whereas it was only present at the 1- and 4-h observations in the other eyes. The irritation gradually subsided completely in all within 2 to 4 days. The sodium fluorescein test was negative for corneal damage.

CTFA (1970a) reported that three male, white rabbits were used in an eye irritation test using a 4% solution of MAS. The test substance (0.01 ml) was instilled into the conjunctival sac of one eye of the animals without irrigation. Acute reactions were evaluated at 1 and 4 h, and 1, 2, 3, 6, and 7 days after application according to the Draize scoring system. The average irritation score at the time of maximum score (1 h) for the cornea, iris, and conjunctivae was 0, 0, and 6.7, respectively. The average total score was 6.7 suggesting that MAS produced minimal eye irritation under these test conditions.

Sodium Magnesium Silicate

Three male, white rabbits were used in an eye irritation test using a 4% solution of Sodium Magnesium Silicate (in deionized water). The test substance, 0.1 ml, was instilled into one

eye of the animals without irrigation. Eye reactions were evaluated at 1 and 4 h, and 1, 2, 3, 6, and 7 days after application according to the Draize scoring system. The average irritation score at the time of maximum score (1 h) for the cornea, iris, and conjunctivae was 0, 0, and 6.0, respectively. The average total score was 6.0, suggesting that Sodium Magnesium Silicate had minimal eye irritation under these test conditions (CTFA 1970b).

Zeolite (Zeolite A)

In an acute ocular study, rats tolerated a single dose of 10 g of Zeolite A without any adverse reaction (Gloxhuber et al. 1983).

Zirconium Silicate

Gingival tissue was histologically examined in a study conducted by Stookey et al. (1967). Six weanling albino rats were given an oral prophylaxis using a paste containing 75% Zirconium Silicate and 25% distilled water. The animals were anesthetized and given a routine prophylaxis for 30 s per mandibular hemijaw. Three of the animals were killed 1 h following treatment. The other three animals were killed 24 h following treatment. Gingival tissue of the buccal surface of the mandibular molar areas were removed for microscopic examination.

No unusual tissue response was observed in either group. At 1 h, scattered particles of Zirconium Silicate were noted on the surface of the gingiva. Occasional particles could be identified in the superficial epithelium. Only an occasional mild local inflammatory response was noted in the subepithelial tissue. It was presumed to be secondary to the prophylaxis procedure (Stookey et al. 1967).

REPRODUCTIVE AND DEVELOPMENTAL TOXICITY

Calcium Silicate

FDRL Inc. (1973) conducted a study in which adult, Dutch-belted female rabbits were artificially inseminated and received oral intubations of Calcium Silicate at doses of 250, 500, 750, 1000, 1250, 1500, and 1600 mg/kg on days 6 through 18 after insemination. On day 29, cesarean section was performed and the numbers of corpora lutea, implantation sites, resorption sites, and live and dead fetuses were recorded. Body weights of live pups were recorded. The urogenital tracts of the animals were examined in detail. All fetuses underwent detailed gross examination. Calcium Silicate administered at 1600 mg/kg to pregnant rabbits for 13 consecutive days had no clear discernible effect on nidation or on maternal or fetal survival. Skeletal or soft tissue abnormalities did not differ from the number occurring in control groups.

Kaolin

Groups of 12 Sprague-Dawley female rats were fed three diets: control diet, 20% Kaolin diet, or iron-supplemented 20% Kaolin diet. The diets were fed for 37 to 86 days, 69 to 85 days, and 96 to 117 days prior to fertilization. These same diets were fed for the duration of the gestation period. The animals fed

the 20% Kaolin diet had significant reductions in hemoglobin, hematocrit, and RBC numbers, indicating maternal anemia. Significant reduction in the birth weight of the pups was observed. Animals fed the iron-supplemented diet maintained their hematocrit, hemoglobin, and RBC levels (Patterson and Staszak 1977).

Magnesium Aluminum Silicate

According to Sakai and Moriguchi (1975), "MAS has neither teratogenic nor had adverse effects on the mouse fetus." MAS was administered at doses of 600, 3000, and 6000 mg/kg/day orally to pregnant mice (ICR-JCL) for 6 days on the 7th to 12th day of gestation. No significant differences between MAS-administered and control groups were observed in body weight gain, gross lesions, implantations, resorbed or dead fetuses, or growth inhibition of live fetuses. Incidences of skeletal anomalies were significantly greater in MAS-exposed fetuses, but none resulted in skeletal malformation. Development, external differentiation, body weight gain, and behavior were normal in all offspring.

Zeolite (Type A)

Type A Zeolite containing 15.8% sodium 19.0% silicon, and 20.1% aluminum was tested for its teratogenic potential by Nolen and Dickerman (1983). Sprague-Dawley rats and New Zealand rabbits were utilized under the standard FDA Segment II protocol. Zeolite A in distilled water was given to rats by gavage at concentrations of 74 or 1600 mg/kg of body weight on days 6 to 15. Rabbits were given doses of 74, 345, and 1600 mg/kg of Zeolite A by oral gavage on days 6 to 18. Vehicle controls were included but no details were provided. Type A Zeolite produced no adverse effects on the dam, embryo, or fetus in either the rats or rabbits at any dose.

Zeolite (Clinoptilolite)

Pond and Yen (1983a) investigated whether Clinoptilolite offers protection against the toxic effect of long-term cadmium ingestion by examining the effects of long-term ingestion of Clinoptilolite on reproduction and on the postnatal development of the progeny. Four groups of female Sprague-Dawley rats were fed the following diets: control; control and Clinoptilolite; control plus cadmium; and control plus cadmium and Clinoptilolite. At 13 weeks, male rats were placed with the females for mating. The female reproductive performance was unaffected by any of the various diets. The supplemental level of Clinoptilolite resulted in reduced body weight during gestation; body weight at parturition and postpartum was similar for rats of all diet groups.

GENOTOXICITY

Attapulgit

DNA damage caused by Attapulgit was evaluated through the measurement of unscheduled DNA synthesis (UDS) in a

study conducted by Denizeau et al. (1985b). Hepatocytes-taken from male Sprague-Dawley rats were prepared according to the collagenase perfusion technique. Attapulgit fibers were added at concentrations of 1 and 10 $\mu\text{g/ml}$ to the primary cultures 2 h after the cells were seeded. 2-Acetylaminofluorene (AAF), a known UDS-inducing agent of rat hepatocytes, was added to the cultures at 0.05 and 0.25 $\mu\text{g/ml}$ for each concentration of Attapulgit. Therefore, Attapulgit was used alone in this UDS assay system or in combination with AAF. The cultures were incubated for 20 h. Labeled thymidine was added to final concentration of 4 $\mu\text{Ci/ml}$. The amount of thymidine in the DNA was evaluated by liquid-scintillation counting. Cytotoxicity was also measured in this study by measuring LDH activity using a spectrophotometer.

A significant increase in [^3H]-thymidine incorporation took place with the addition of AAF (0.05 and 0.25 $\mu\text{g/ml}$). However, at both Attapulgit concentrations, no significant increase in DNA-specific activity was observed. No alteration occurred in the UDS (induced by AAF) by secondary agents when both the fibers and AAF were applied. No statistically significant fiber effect of AAF-fiber interaction was recorded. Extracellular LDH activity was observed after 20-h incubations of Attapulgit at 1 and 10 $\mu\text{g/ml}$ applied to the cells. No significant differences were found between the LDH activity in the treated samples versus the controls (Denizeau et al. 1985b).

Beck and Bignon (1985) tested Attapulgit and UICC chrysotile asbestos B for UDS in primary hepatocyte cultures. Attapulgit fibers (96%) averaged 0.8 μm in length. Cells were also exposed to AAF alone and mixed with fibers. Within 20 h, both types of fibers were found in various cell structures, i.e., plasma membrane invaginations, cytoplasmic vacuoles, and phagolysosome-like components. Chrysotile B and Attapulgit did not induce a significant UDS response or modulate the response to AAF.

The UDS and cellular growth was studied utilizing rat pleural mesothelial cells (RPMCs) in a study conducted by Renier et al. (1989). RPMCs were cultured to confluence on glass coverslips in multiwell plates. Concentrations 2, 4, and 10 $\mu\text{g/cm}^2$ of Attapulgit and [^3H]-thymidine were added to cultures for 20 h. UDS was not modified at concentrations of 2 and 4 $\mu\text{g/cm}^2$ of Attapulgit. However, in one experiment, 10 $\mu\text{g/cm}^2$ produced a significant increase in UDS. Cellular growth was measured by counting in situ with an inverted phase-contrast microscope after 24 h of treatment of 1, 2, 4, and 10 $\mu\text{g/cm}^2$ of Attapulgit. Results were similar to that of the UDS. Attapulgit was considered noncytotoxic at concentrations of 1, 2, and 4 $\mu\text{g/cm}^2$. However, at 10 $\mu\text{g/cm}^2$, cell growth was inhibited. No specific details were given.

Adachi et al. (1992) studied the effect of asbestos fibers on DNA by measuring the yield of 8-hydroxy-2'-deoxyguanosine (8-OH-dGuo). 8-OH-dGuo is an OH adduct at the 8-position of a guanine base thought to induce an AT-to-GC transversion in DNA which may lead to a point mutation. For comparison purposes, Attapulgit was also studied. Results for

Attapulgit were not different from controls (Adachi et al. 1992).

Calcium Silicate

Litton Bionetics, Inc. (1974) conducted a study in which FDA compound 71-41, hydrated Calcium Silicate, was suspended in 0.85% saline at concentrations of 1000, 500, 200, 100, and 10 $\mu\text{g/ml}$ and applied to WI-38 cells in a logarithmic phase of growth. The cells were observed for cytopathic effects (CPEs) and the presence of mitosis at 24 and 48 h. Inhibition of mitosis was observed at all concentrations except 100 and 10 $\mu\text{g/ml}$. A closer range of concentrations, 200, 150, 100, 75, and 50 $\mu\text{g/ml}$, were employed and tested for the same findings. Mitosis was stopped only in the cells dosed at 200 $\mu\text{g/ml}$.

FDA compound 71-41, hydrated Calcium Silicate, was also tested for mutagenic properties in a host-mediated assay using the microorganisms *Salmonella* TA-1530 and G-46 and *Saccharomyces* D3. These experiments were carried out in mice orally administered (acute and subacute) 15, 150, and 1500 mg/kg of Calcium Silicate. No increased mutation frequencies were seen in *Salmonella* TA-1530 or G-46. *Saccharomyces* D3 had no significant increase in recombinant activity. In fact, a reduction in recombinant activity was produced by the compound. In a second host-mediated assay, Calcium Silicate was administered at 5000 mg/kg to mice against *Salmonella* TA-1530 and G46 and *Saccharomyces* D3. All tests were negative.

Cytogenetic studies in vivo examined bone marrow cells arrested in C-metaphase from rats exposed to FDA compound 71-41, Calcium Silicate. Rats were administered 15, 150, and 1500 mg/kg doses. The positive-control was triethylene melamine (TEM) and the negative-control was saline. The chromosomal abnormalities observed in the positive-control animals were significantly greater than those of either the negative control or the compound. The maximum effect of the positive control was observed at 48 h after administration. Calcium Silicate produced breaks in the range of 1% to 3% in all three acute dosage levels. However, these were not significantly higher than the negative controls. The subacute dose of 150 mg/kg produced breaks at 3%. The negative-control breaks were consistent with those of other experiments.

These same cytogenetic tests were observed in vitro. Cells (not specified) were observed in anaphase for chromosomal aberrations such as bridges, pseudochiasmata, multipolar cells, acentric fragments, etc. Doses of Calcium Silicate were as follows: 1.0, 10.0, and 100.0 $\mu\text{g/ml}$. Controls, both positive and negative, were the same as reported above. The positive control produced significantly greater percentages of chromosomal aberrations than the negative control or test compound. There were no aberrations observed due to Calcium Silicate.

In a third cytogenetic test, Calcium Silicate was administered to male rats in one dose and in five doses of 5000 mg/kg. A positive-control, TEM, and a negative-control, saline, were also tested. Metaphase spreads were prepared from the bone marrow cells of these animals and scored for chromosomal aberrations.

Neither the variety nor the number of the aberrations differed significantly from the negative controls. Calcium Silicate was nonmutagenic.

Dominant lethal assays were carried out in male rats administered FDA compound 71-41, hydrated Calcium Silicate, at doses of 15, 150, and 1500 mg/kg, both as one dose and as five doses. Also tested were the negative saline control and a positive TEM control. This assay measures the amount and type of fetal wastage that may occur following administration of a potential mutagen. Each treated male rat was mated with two virgin female rats each week for eight (acute) or seven (subacute) doses. Two weeks after mating, the female rats were sacrificed and the fertility index, preimplantation loss, and lethal effects were determined and compared with the same parameters calculated from the negative and positive controls. No significant findings were observed in the fertility index or preimplantation loss. The test compound was also administered at a dose of 5000 mg/kg. The protocol was the same as listed above. All parameter values did not differ significantly from that of the negative control. Comparing the data of both experiments indicates that hydrated Calcium Silicate does not induce dominant lethal mutations (Litton Bionetics, Inc., 1974).

Hectorite

Hectorite suspended in dimethylsulfoxide (DMSO) at concentrations of 10 to 3000 $\mu\text{g/plate}$ was subjected to spot test using five mutant strains of *Salmonella typhimurium* LT2, hisTA98, hisTA100, hisTA1535, hisTA1537, and hisTA1538, with and without metabolic activation. Positive controls were carried out utilizing Aroclor 1254. Hectorite was nonmutagenic in all five test strains (Inveresk Research International 1995).

Magnesium Aluminum Silicate

MAS was subjected to spot test using five mutant strains of *S. typhimurium* LT2, hisTA98, hisTA100, hisTA1535, hisTA1537, and hisTA1538. Positive and negative controls were carried out utilizing S9 mitochondrial preparations from the livers of Sprague-Dawley rats and 2-aminoanthracene. MAS was found to be nonmutagenic in all five test strains (Blevins and Taylor 1982).

Zeolite

Durnev et al. (1993) tested the clastogenic potential of Zeolite particles <10 μm in length in peripheral human blood lymphocytes. Chrysotile fibers were used as a positive control. Both fibers produced statistically significant increases in the percentage of aberrant metaphases, mostly from chromatid breaks. Superoxide dismutase (50 $\mu\text{g/ml}$) protected against the induction of aberrant metaphases by chrysotile asbestos, but not by Zeolite. However, catalase (20 $\mu\text{g/ml}$) protected against induction of aberrant metaphases by Zeolite, but not by chrysotile asbestos.

Chromosomal aberrations in cells of C57BL/6 mice were also investigated. The cells were collected by peritoneal lavage and

from the bone marrow of mice and were sampled at 1, 2, 7, and 28 days after the intraperitoneal injection of 100 $\mu\text{g}/\text{mouse}$ natural Zeolite particles. Chrysotile asbestos was used as a positive control. The lavage sample contained 20% lymphocytes, 20% to 30% macrophages, and 50% to 60% PMN leukocytes. The injection of the Zeolite induced a statistically significant increase in aberrant metaphases after 7 and 28 days in the peritoneal lavage cells. Chrysotile induced the aberrant metaphases at all times in both the peritoneal lavage and bone marrow cells (Durnev et al. 1993).

Valatina, Pylev, and Lemjasev (1994), tested the clastogenic effect on bone marrow cells of five dust samples from Zeolite tuffs. Presterilized dusts were administered intraperitoneally to BALB/C mice. The known clastogen mitomycin C was used as a positive control and 0.5 ml of saline as a negative control. The animals were killed 24 h after administration and mice bone marrow samples were taken. Polychromatophilic erythrocytes (PCEs), which contain micronuclei that are formed during mitosis on acentric fragments of the chromosomes as a result of clastogenic actions, were counted. Many of the dust samples were as potent a clastogenic agent as mitomycin C. A summary of the results is listed in Table 21.

CARCINOGENICITY

The IARC (1997) has placed Attapulgitte fibers $>5 \mu\text{m}$ in Group 2B, *possibly carcinogenic to humans*. Fibers $<5 \mu\text{m}$ cannot be classified as to their carcinogenicity to humans and were classified in group 3. The Utrecht University's Institute for Earth Sciences and Vening Meinesz Institute for Geodynamic Research (Engelhard 1998) analyzed Engelhard's Attapulgitte clay by transmission electron microscopy to determine the fiber length. The transmission electron microscopic analytical results was $<5 \mu\text{m}$.

TABLE 21

Micronuclei induced by Zeolite tuffs (Valatina, Pylev, and Lemjasev 1994)

Administered substance	Dose (mg/g)	Amount of PCEs with micronuclei (per 1000 PCEs)
Dust 1	2.0	8.33 ± 0.5
	0.8	5.83 ± 0.5
Dust 2	1.4	2.83 ± 0.3
	2.1	3.83 ± 0.6
Dust 3	3.15	0.5 ± 0.8
	1.26	3.8 ± 0.5
Dust 4	2.15	6.7 ± 0.5
	.86	5.2 ± 0.5
Dust 5	3.25	4.83 ± 0
	1.3	3.66 ± 0.5
Mitomycin C	0.16 mg/kg	7.70 ± 0.3
Saline control	0.5 ml	2.70 ± 0.03

Clinoptilolite, Phillipsite, Mordenite, Nonfibrous Japanese Zeolite, and synthetic Zeolites cannot be evaluated as to their carcinogenicity to humans (group 3) according to the IARC (1997).

Table 22 is a summary of carcinogenicity data, which were detailed earlier in the section *Animal Toxicology*.

CLINICAL ASSESSMENT OF SAFETY

Dermal Irritation

Magnesium Aluminum Silicate

Applications of 2 g of VEEGUM were made to the skin of two human subjects in an 1-inch area daily for 1 week. No effects were noted and no other details were given (Munch 1944).

Inhalation

Aluminum Silicate

Musk et al. (1980) surveyed 17 workers exposed to the Aluminum Silicate dust, alunite. Respiratory questionnaires and occupational history, pulmonary function testing, and posterior-anterior chest radiographs were obtained. The alunite chemical analysis was that 48.5% of it was Al_2O_3 and 35.0% was SiO_2 . The average age of the subjects was 29.1 years. The mean transfer factor for carbon monoxide (T_L) predicted for the whole group was 85.8% and the mean ratio of T_L to effective alveolar volume (V_A) was 83.8%. The actual group T_L and T_L/V_A was less than predicted. Overall, the group had comparable predicted levels of forced expiratory volume (FEV) in 1 second, vital capacity (VC), and total lung capacity (TLC). Two subjects had small irregular opacities on chest films. Neither of these subjects had previous exposure.

Attapulgitte

Churg (1983) surveyed the total pulmonary nonasbestos mineral content in 20 patients who had no occupational dust exposure. The lungs were autopsied and 3- to 5-g pieces were dissolved in bleach and the treated sediment was transferred to an electron microscope grid. Mineral fibers were identified using electron diffraction and energy dispersive x-ray spectroscopy. No correlations were between numbers or types of fibers and age, sex, or smoking. Attapulgitte was identified in 12/20 patients and approximately 8400/106000 fibers (7.9%) were Attapulgitte. Further mineralogical analysis revealed 100% of the Attapulgitte fibers were 1 to 4.9 μm in length.

Kaolin

Churg (1983) surveyed the total pulmonary nonasbestos mineral content in 20 patients who had no occupational dust exposure. The lungs were autopsied and 3- to 5-g pieces were dissolved in bleach and the treated sediment was transferred to an electron microscope grid. Mineral fibers were identified using electron diffraction and energy dispersive x-ray spectroscopy. No correlations were between numbers or types of fibers and

TABLE 22
Summary of carcinogenicity data

Procedure	Dose/concentration	Result	Reference
Aluminum Silicate			
Single intrapleural injections of four samples into rats (lived life span)	20 mg (0–40 μm)	3 malignant mesotheliomas (1 pleural and 2 peritoneal)	Pigott and Ishmael 1992
Calcium Silicate			
Single intraperitoneal injections into rats (lived life span)	25 mg	Little dust or dust-related fibrosis was visible; no mesotheliomas	Bolton et al. 1986
Chronic inhalation exposure for 1 year in rats	10 mg/m ³	Interstitial fibrosis, 1 small squamous cell carcinoma, 1 adenoma in lungs	Bolton et al. 1986
Attapulgit			
Single intraperitoneal injections into rats	25 mg	Tumor incidence rate was 67%	Pott, Huth, and Friedrichs 1974
Single direct pleural application to left pleural surface of rats (killed 2 years later)	40 mg	17/615 of treated rats developed pleural sarcomas	Stanton et al. 1981
Single intrapleural injections into rats (lived life span)	20 mg/ml of 0.9% NaCl (0.77 μm)	No mesothelial neoplasms in either control or treated rats	Jaurand et al. 1987
Single intraperitoneal injections into rats (lived life span)	No concentrations given (fiber lengths ranged from 0 to 25 μm)	46 mesotheliomas	Wagner, Griffiths, and Munday 1987
Single intrapleural injections into rats (lived life span)	20 mg (0.77 μm)	No mesotheliomas	Renier et al. 1989
Single intrapleural injections into rats (lived life span)	0.5, 2, 4, 8, 16, or 32 mg (<1 μm)	2/140 had mesotheliomas	Coffin, Cook, and Creason 1992
3 samples were injected one time each week for 9 weeks into rats (surviving animals were killed at 2.5 years)	60 mg (0.04 to 0.8 μm)	Noncarcinogenic results for all three samples	Pott et al. 1987
Single intraperitoneal injections were administered for 3 weeks in rats (killed at 2.5 years)	2, 4, and 4 mg (1.3 and 0.07 μm)	40% of 30 rats had neoplasms	Pott et al. 1987
Inhalation chamber exposure to rats for 6 h/day for 5 day/week (killed at 3, 6, and 12 months)	10 mg/m ³	2 mesotheliomas, 2 peritoneal mesotheliomas, 1 malignant alveolar neoplasm, 2 benign alveolar neoplasms, 11 bronchoalveolar hyperplasias	Wagner, Griffiths, and Munday 1987
Zeolite			
Oral administration for 104 weeks in rats	1, 10, 100, or 1000 mg/kg	No incidence of neoplastic changes	Glohuber et al. 1983
Single intratracheal instillations into rats (killed at end of study)	30 and 60 mg (< 5 μm)	No significant increase in the incidence of any specific neoplasm	Tatrai and Ungv'ary 1983
Single intraperitoneally injections into mice (10 month study)	10 or 30 mg (< 5 μm)	No neoplastic changes were observed	Suzuki 1982
Single intraperitoneal injection into mice	10 mg (<3 μm)	Mild peritoneal fibrosis but no neoplasms	Suzuki and Kohyama 1984

(Continued on next page)

TABLE 22
Summary of carcinogenicity data (*Continued*)

Procedure	Dose/concentration	Result	Reference
Single intraperitoneal injections into mice (7–23-month exposure)	10 mg (2.24 μm)	No mesotheliomas observed	Suzuki and Kohyama 1984
Single intrapleural injection into rats (chronic study)	20 mg	1 pleural and 1 peritoneal mesothelioma	Wagner et al. 1985
Single intraperitoneal injections into rats (141 weeks)	25 mg	1 peritoneal mesothelioma	Maltoni and Minardi 1988
Single intrapleural injections in rats	25 μm	No difference in tumor incidence between control and treated groups	Maltoni and Minardi 1988
Single subcutaneous injections	25 μm	No difference in tumor incidence between control and treated groups	Maltoni and Minardi 1988
3 intrapleural injections were given in monthly increments to rats	20 mg (3 to 500 μm)	2 mesotheliomas and 1 bronchial carcinoma/93 treated animals	Pyev et al. 1986
3 intrapleural injections were given in monthly increments to rats	20 mg (5 to 100 μm)	Neoplasms were found in 41/101 animals	Pyev et al. 1986
Inhalation exposure to rats for 7 h/day, 5 days/week for 1 year (lived life span)	10 mg/m ³	1 mesothelioma and 1 pulmonary adenocarcinoma	Wagner et al. 1985

age, sex, or smoking. Kaolin was identified in 12/20 patients and approximately 3500/106000 (3.3%) fibers were Kaolin. Further mineralogical analysis revealed 94% of the Kaolin fibers were 1 to 4.9 μm in length.

Morgan et al. (1988) surveyed and studied the prevalence of ventilatory impairment, chest symptoms, and radiographic abnormalities in over 2000 Kaolin workers representing over 95% of the current employees in the industry. Of the participants, 19% admitted having a cough. Of those participants with a cough, 17% had an abnormal FEV and 14% had an abnormal VC. Of those without a cough, 5.5% had an abnormal FEV and 7% had an abnormal VC. Also, 18% of the participants admitted to chronic sputum production. Of those with sputum production, 16% had abnormal FEV, and 12.5% had abnormal VC. Of those without the production, 6% had an abnormal FEV, and 7.5% had an abnormal VC. About 30% of the participants complained of shortness of breath, 3.1% was classified as severe. Wheezing was reported by 29% of the subjects. Satisfactory chest films for 2069 of the subjects were available for examination. Radiographic findings of 90 subjects revealed simple pneumoconiosis. Of these cases, 3.16% had category 2 pneumoconiosis, 1.0% had category 5, and 0.25% had category 3. Eighteen subjects (0.89%) had complicated pneumoconiosis. Of these cases, five had stage A, eight had stage B, and five had stage C. Of men with either case of pneumoconiosis, 51.1% were dry processors, compared to 6.3% of the men who worked in wet processing. Of the non-smoking participants (549), 542 and 537 men had a satisfactory FEV and forced vital capacity (FVC), respectively, in addition to an acceptable chest radiograph. Of these nonsmoking workers,

516 were studied for dust exposure and pulmonary function. Among the nonsmokers with no pneumoconiosis, those persons working in calcined clay had a greater prevalence of lung function abnormalities. This group had a significant increase in the risk of having an abnormal FEV but tended to have less incidences of pneumoconiosis. In short, ventilatory impairment was related to the presence of complicated pneumoconiosis, employment in clay calcining, and cigarette smoking. Also work in dry processing was associated with a greater risk of developing pneumoconiosis (Morgan et al. 1988).

Waxweiler et al. (1988) evaluated the possible health effects of occupational exposure to Attapulgate. A cohort study of 2302 men employed for at least 1 month at an Attapulgate mining and milling facility was followed through 1975. A significant deficit of mortality from nonmalignant respiratory disease (NMRD) was observed based on age, calendar year, and rates was observed. A marked deficit of NMRD was seen regardless of presumed dust exposure level, induction-latency period, or duration of employment. A statistically significant excess of mortality from lung cancer was observed among whites, but a deficit occurred among nonwhites. Lung-cancer risk in either race was not altered substantially with presumed dust exposure level, induction-latency period, or duration employed, with one exception—those employed for at least 5 years in high-exposure-level jobs. An increased mortality was observed for gastric cancer (six observed) and a deficit due to nonmalignant respiratory disease was observed (nine observed).

The lungs of 62 recently deceased men between the years of 1968 to 1981 were taken for an assessment of the severity

of lung disease (Wagner et al. 1996). Fifty-four of the 62 men worked with china clay or china stone. All the test subjects were employed in the mining industry. Test subjects were divided into groups according to their contact with the minerals: dusty china clay; wet, nondusty china clay; china stone; other dusty environments. The authors of this publication define china clay as "consisting mainly of the mineral kaolinite and in most other countries it is referred to as Kaolin." China stone "consists essentially of a mixture of quartz, feldspars, micas, and amorphous silicon dioxide." Chest radiographs were available for 39 of the 62 cases. Sections of lung tissue were examined microscopically for nodular and interstitial fibrosis and an overall grade ranging from 0 (none) to 3 (severe). Samples from 42 cases were analyzed for mineral content by x-ray diffraction and lung-dust concentrations.

Radiographic lesions included 13 cases of progressive massive fibrosis and 22 cases of simple pneumoconiosis. Only four cases had no evidence of any disease. Nodular opacities tended to reflect a high quartz content, whereas high-Kaolin lung content had interstitial changes and irregular radiological changes.

Mineralogical analysis of the 42 cases revealed two separate groups of mineral composition and one miscellaneous group. The china clay group was composed of $\geq 90\%$ Kaolinite in its samples consisted of 16 cases. The other distinct group, the clay and stone group, was composed of $< 90\%$; Kaolinite and greater contents of subsidiary components including quartz comprised 16 cases. The other group had a large variation of mineral composition. Lung-dust concentrations were greatest in the china clay group as shown in Table 23.

The grades of nodular fibrosis ranged in the china clay group from 0 (none) to 2 (moderate—up to 7 nodules/section or nodules of 3 to 6 mm in diameter). In china stone/clay group half, 8 of 16, were grade 3 (severe—more than 7 nodules/section or 6 to 10 mm in diameter). An increasing quartz concentration appears to be related to nodular fibrosis. Interstitial fibrosis in group ranged from 1 (slight—fibrosis located around respiratory bronchioles, which may extend into alveolar ducts and adjacent alveoli, but with areas remaining free of fibrosis between adjacent respiratory bronchioles) to 3 (severe—widespread diffuse fibrosis with few recognizable alveoli; honeycomb may or may not be present). No correlation was found between Kaolinite concentration and interstitial fibrosis grades; however, the china

clay group had little exposure to anything but china clay. The degree of interstitial fibrosis appears to be more related to dust lung concentrations, although these results failed to reach statistical significance (Wagner et al. 1996).

The ACGIH does not classify Kaolin as a human carcinogen and gives a TLV-TWA of 2 mg/m^3 for respirable dust and total dust (ACGIH 1997).

Zhang, Zhang, and Song (1997) reported the results of environmental monitoring and health surveillance performed on 781 Pyrophyllite miners and Pyrophyllite dust carvers from the years of 1954 to 1986. Routine radiographs of the workers lungs were studied for lesions of pneumoconiosis. The PM workers were divided into three groups, manual drillers (A), mechanical dry drillers (B), and mechanical wet drillers (C). The PCM workers were divided in two groups, carvers in factories (A) and carvers working at home (B).

PM workers, group B, had a greater incidence (43.5%) of pneumoconiosis than all other groups. In order to exclude the effect of the duration of exposure (DE), the DE-adjusted prevalence rate was calculated. The DE-adjusted rates are as follows, PM groups, 36.6% and PCM groups, 14.4% of pneumoconiosis (Zhang, Zhang, and Song 1997).

Case Reports

Aluminum Silicate

Sherwin (1979) found abnormal numbers of birefringent particles in the lungs of seven patients: five vineyard workers, one farmer, and one rural resident. A spectrum of early-to-late interstitial inflammation and fibrosis were seen. Nodular granulomas seen in silicosis were absent. Mineralogical analysis revealed mostly silicates, i.e., aluminum and potassium silicate.

Musk, Greville, and Tribe (1980) reported a case of a 42-year-old woman who had no history of previous exposure to Aluminum Silicate dust until she started working at an alunite-residue bagging mill. Chemical analysis of the alunite-residue showed 48.5% of constituents to be Al_2O_3 and 35.0% to be SiO_2 . Eight months after working, she noticed the onset of dry cough and shortness of breath. Within 3 months these signs lasted throughout the day. She remained working for 18 months and after leaving work, the cough completely subsided within 3 months. She also complained of pain and morning stiffness in joints, wrists, elbows, and right knee. Corticosteroid treatment was started after a lung biopsy. A chest film taken 3 months after the onset of symptoms had lesions of diffuse small irregular opacities throughout both lungs. Subsequently, pulmonary function tests revealed a decrease in transfer factor for carbon monoxide (TL) and effective alveolar volume (TL/VA) and abnormal transpulmonary pressure–lung volume relationships. Pulmonary lesions included examination interstitial infiltration with small round cells, variable fibrosis, and scattered granulomas. Alveoli were distorted and the granulomas were moderately well formed with multinucleate giant cells and epithelioid histiocytes. After corticosteroid treatment, no increase in severity of the lung lesions was seen.

TABLE 23

Dust concentrations in lung tissue of deceased men who worked in the mining industry (Wagner et al. 1996)

Mineral group	Lung dust concentrations (mg/g)		
	Minimum	Maximum	Median
China Clay (a)	7.6	289.3	40.0
China Stone/Clay (b)	4.1	44.8	15.0
Miscellaneous (c)	1.6	28.7	6.5

Calcium Silicate

A 23-year-old man was involved in the bagging process of a food additive. The food additive produced a white thin layer of powder that continuously covered the work floor. An antibiotic, carboxymethylcellulose, and Calcium Silicate comprised the food additive. On the third day of working, the patient experienced an itchy eruption on his face, neck, and forearms. The rash was erythematopapular with no vesicles. The redness was not diffuse and patches of erythema and papules were confluent on the neck and forearms. All signs faded the following morning. The rash occurred again when the patient returned to work. Patch tests were performed using the food additive, an antibiotic, carboxymethylcellulose, and Calcium Silicate. All tests were negative and there were no clinical signs of irritation at the test sites. No late reaction was recorded either. A sample of the food additive was examined under the microscope. Analysis revealed sharp-edged particles corresponding to Calcium Silicate. It was determined that the Calcium Silicate dust caused an "airborne irritant contact reaction." The problem was eliminated by increasing the humidity in the workplace and aspirating the air (Lachapelle 1984).

Bentonite

Phibbs, Sundin, and Mitchell (1971) reported many case studies involving Bentonite workers. Some milling plants had dangerous concentrations of silica that ranged from 2 to 10 times the safe maximal concentration according to the U.S. Bureau of Mines. Silicotuberculosis developed in four patients studied.

Austin and Doughman (1980) reported a 20-year-old dental assistant who noted a foreign body in her right eye after using a drill to polish a patient's teeth with Prophypaste. Immediately she noticed decreased vision and photophobia. Several opaque deposits superficially embedded in her right cornea were removed within 2 h. There was no evidence of corneal perforation or iritis. A residual superficial corneal infiltrate was noted paracentrally. An anterior uveitis developed and was treated. One month after the injury, the cornea was edematous with a superficial, peripheral ringlike stromal infiltrate and a deep inferior stromal infiltrate. A retrocorneal abscess was present. There was no eyelid edema present. Culture results were negative. Anterior segment inflammation, progression of the corneal edema, and an enlarged ring abscess in the corneal stroma continued. There was complete loss of red reflex and iris detail. The diagnosis was infectious endophthalmitis and anterior chamber and vitreous aspirations were performed. No organisms were seen but a few PMN leukocytes were present in the aspirations. These authors undertook the toxicity studies in rabbits presented in the ocular animal toxicity section under Bentonite. They concluded that the similarity of the findings in animals after injection of Bentonite with the findings in this case report suggested that Bentonite was the responsible agent in the dental assistant's symptoms.

Fuller's Earth

Tonning (1949) reported a man having worked in a Fuller's Earth plant as a young man. The length of employment was estimated at no more than 15 years. He was diagnosed with terminal aspiration pneumonia, pneumoconiosis due to Fuller's Earth exposure, bilateral emphysema, and fibrous pleural adhesions. Lesions differed from typical silicotic lesions of the lungs; no formations of the whorled, acellular collagen typical of silicotic nodules were observed. Isolated cavities in the apices were filled with black sludge and surrounded by vascular and cellular collagen. The dust in the lymph nodes had only stimulated the formation of reticulin fibers. No subpleural nodules were present. At mineralogical analysis, the Fuller's Earth deposits were constituted mainly of Montmorillonite (85.2% to 90%).

Sakula (1961) reported two cases of pneumoconiosis due to Fuller's Earth (Table 24). Mineralogical analysis of the Fuller's Earth established Montmorillonite as the major component.

Kaolin

Lynch, Harrison, and Nagelschmidt (1954) investigated two case studies of men who worked in a Kaolin-processing plant for many years. The lungs of the two persons and chest x-ray films were evaluated. The first case was a 36-year-old man who worked on the plant for 17 years. Chest films were taken at the end of his career and detected lesions of extensive confluent consolidation and nodule formation of advanced pneumoconiosis with infection. Autopsy and microscopic findings included alveolar spaces uniformly expanded, three areas of whorled fibrous tissue, scattered areas of cystic spaces, hilar nodes heavily pigmented, deposits of brownish black particulate matter, a large vessel with recent thrombus, hemorrhage, and necrosis, marked fibrous thickening of the pleura, and dense fibrous scarring of the lymph nodes. The final diagnosis was pneumoconiosis (kaolinosis) with pulmonary thrombosis and infarction of the lungs. The second case study was a 35-year-old man who worked in a Kaolin-processing plant for 21 years. Within his last 3 years, he had dyspnea and a slight cough with small

TABLE 24
 Pneumoconiosis cases reportedly linked to exposure to Fuller's Earth (Sakula 1961)

Patient	Symptoms
Male who worked in a Fuller's Earth processing plant for 42 years	Fine to medium miliary mottling of both lungs; sputum examinations were negative for <i>M. tuberculosis</i> ; slowly deteriorating pulmonary function; recurrent bronchitis
Male who worked for 28 years in milling	Chronic cough and sputum; fine miliary mottling throughout both lungs; increasing dyspnea

TABLE 25
Pneumoconiosis cases reportedly linked to exposure to Kaolin (Hale et al. 1956)

Patient	Symptoms	Diagnosis
44-year-old man; worked in a Kaolin mill for 28-years	Cough with thick white sputum; easily dyspneic on slight exertion; well-marked nodulation of silicotic type with coalescence of the nodules in several areas and emphysema	Pneumoconiosis
67-year-old man; worked in china clay bagging for nearly his entire life	Several years of a productive cough; emphysema; massive fibrosis on both sides; no evidence of neoplasm	Pneumoconiosis
44-year-old man; worked in china clay bagging for nearly his entire life	Diffuse nodular mottling with considerable attenuation of the bronchovascular markings	Pneumoconiosis
39-year-old man; worked 14 years with clay	Fine miliary mottling in both lungs; well-marked calcification at the left hilum	Pneumoconiosis
73-year-old man; worked 12 years in open limestone quarries	Small discrete nodular mottling with an increase in the root shadows and the lung markings	Pneumoconiosis
64-year-old man; 43 years loading china clay	Cough and shortness of breath; emphysema; definite nodular mottling	Pneumoconiosis

amounts of dark colored sputum. The sputum was negative for bacteria. Chest films revealed advanced pneumoconiosis with infection, confluent consolidation, nodular infiltration, cavitation, and emphysema. Autopsy and microscopic findings included nodules in the right and middle lobes, pleural spaces were thickened and shaggy, large bulbous emphysematous blebs, a pulmonary artery with organizing thrombus, heavily pigmented hilar lymph nodes, whorled fibrous collagenous tissue, and spaces and walls with macrophages. The final diagnosis was pneumoconiosis (kaolinosis).

Hale et al. (1956) reported six cases of pneumoconiosis due to Kaolin. These are given in Table 25 and not further discussed here.

Butz (1970) reported that a 47-year-old man who was a chronic intravenous drug user died from tetanus. The man had been injecting paregoric, a camphorated opium tincture containing 35 to 46 mg of morphine per 100 ml. Paregoric can be found in proprietary preparations that do not require prescriptions; intravenous drug users often attempt to separate the paregoric from the Kaolin. Often the injection of Kaolin, either through shunts in the lung of an intravenous drug user with obliterative pulmonary arteritis and angiomatoid formations or by extrusion from the arterial lumen and transfer to the pulmonary veins, allows the Kaolin crystals to go into the peripheral circulation. In this patient, numerous skin abscesses were noted on the neck, shoulders, upper extremities, chest, thighs, and lower extremities. In skin sections, the lesions were multiple foreign body granulomata and large birefringent crystals. Adhesions over the pleural surface of the lungs were also noticed. At microscopic examination the lungs had foreign body granulomata within the pulmonary arterioles. Extensive pulmonary edema and masses of pigmented histiocytes filled the alveolar spaces. Extensive periportal fibrosis was seen in the liver. The central nervous system lesions were extremely fine, double refractile particles in nerve bundles entering the anterior roots in the central region.

Herman, Olscamp, and Weisbord (1982), reported a patient with multiple pulmonary Kaolin granulomas. The man had a history of bilateral recurrent pneumothorax. Both pleural spaces were destroyed with a suspension of liquid Kaolin. Recurrent right-sided pneumothorax devolved and reobliteration was again performed. In a follow-up chest radiograph, multiple well-defined peripheral nodules were in both lungs and pathological analysis revealed a bland acellular material surrounded by chronic inflammatory cells. By light microscopy, the particles were consistent with Kaolin. It was presumed that Kaolin entered the lungs through pleuroalveolar or pleurobronchial openings.

Lapenas and Gale (1983) reported that a 35-year-old man who worked at a Kaolin-processing plant for 17 years complained of chest pain and was hospitalized. For the previous 2 years before admittance, the man had packaged dried, processed Kaolin. Chest films revealed diffuse reticulonodular pulmonary infiltrates and a well-defined, noncalcified mass in the upper right lobe. A thoracotomy was performed and an 8 × 12 × 10-cm conglomerate pneumoconiotic lesion containing large amounts of Kaolin was found. X-ray diffraction material from the lesion had peaks corresponding to Kaolinite. The presence of silica was not confirmed by x-ray diffraction.

Lapenas et al. (1984) obtained pulmonary tissue from five Kaolin workers with advanced pneumoconiosis. Chest radiographs detected small irregular shadows and large opacities typical of Kaolin pneumoconiosis. At autopsy, firm, grey-brown nodules and masses were in the parenchyma and in the hilar lymph nodes. Microscopic lesions were extensive pulmonary Kaolinite deposition associated with the formation of peribronchiolar nodules. The nodules were comprised of Kaolinite aggregates transversed by bands of fibrous tissue rather than dense whorled collagen. Kaolin was detected in the lungs. Silica was not detected by either analytical scanning electron microscopy or x-ray diffractometry.

Levin et al. (1996) investigated the death of a 62-year-old man who worked in a cotton textile mill for 43 years. The patient complained of progressive dyspnea and a productive cough. After being admitted to the hospital, a bronchoscopy was performed and no endobronchial lesions were found. A lung biopsy had lesions of severe interstitial fibrosis with bronchioalveolar structures extensively involved in the fibrotic process. Pathological alterations such as bronchiolectasis, interstitial fibrosis with thickening of alveolar septa, mobilization of macrophages, and multinucleated giant cells were identified. Neither ferruginous bodies nor pleural hyaline plaque was identified. Kaolin particles were present with a mean size of 0.88 μm . Chrysotile asbestos was also detected, but the majority of particles were Kaolin. The man died as a consequence of respiratory failure despite an aggressive therapy of antibiotics and tuberculosis therapy.

Magnesium Trisilicate

Lee et al. (1993) reported a case of a 30-year-old female with a long-term history of ingesting trisilicate-containing antacids. The patient had repeated attacks of renal colic but the presence of calculi could not be determined by intravenous pyelography nor ureteroscopy. X-ray diffraction did detect a silicate stone. The patient stopped taking trisilicate containing products. The frequency of stone passage decreased and the renal colic was relieved.

Montmorillonite

A 73-year-old Montmorillonite worker developed signs of pneumoconiosis. A chest radiograph was taken 2 years before his death and a bilateral fine reticulonodular shadowing was observed. The man died of acute gastrointestinal hemorrhage from a benign gastric ulcer. A few weeks before his death another chest radiograph indicated a slight increase in the reticulonodular opacities and a mass at the left hilum and apex. At autopsy, numerous soft stellate grey-black dust lesions 4 to 5 mm in diameter that occupied most of the lungs were found. No lesions of progressive massive fibrosis were identified. Also present were lesions of severe emphysema and a 4-cm diameter neoplasm arising from the bronchus of the left upper lobe. At microscopic examination, numerous interstitial collections of dust-laden macrophages were situated around the respiratory bronchioles and along the adjacent alveolar septa. There was a slight degree of fibrosis associated with the dust lesions and the neoplasm was a poorly differentiated adenocarcinoma containing giant cell areas. Mineralogical analysis showed a large amount of calcium Montmorillonite (Gibbs and Pooley 1994).

Zeolite

Casey et al. (1985) reported a patient living in the Nevada desert who developed extensive pleural thickening and interstitial fibrous associated with the pulmonary deposition of Zeolite. An open biopsy of the right lung and pleura was performed on the 52-year-old man. Mycobacterial and fungal cultures were negative. Histopathological evaluation established lesions of chronic

inflammation and fibrosis and presence of many fibrous and nonfibrous particles. The particles were analyzed by SEM and were identified as aluminum silicates. The analytic pattern was characteristic of Zeolites. No asbestos fibers were found and exposure to these fibers was unlikely.

Zirconium Silicate

A nonsmoking 25-year-old woman developed a worsening dry cough and dyspnea after 3.5 years as a tile sorter and glazer. The woman had a history of atopic dermatitis and at age 13 developed pneumonia. An open lung biopsy specimen had lesions of a severe granulomatous interstitial pneumonia with mild fibrosis and numerous very small birefringent crystals around the terminal airways and occasionally in the granulomas. Pulmonary particle analysis established a dust burden almost 100 times the normal. The particles consisted mainly of clay minerals and Zirconium Silicate (Lippo et al. 1993).

SUMMARY

This report provides a review of the safety of Aluminum, Calcium, Lithium Magnesium, Lithium Magnesium Sodium, Magnesium Aluminum, Magnesium, Sodium Magnesium, and Zirconium Silicates, Magnesium Trisilicate, Attapulgit, Bentonite, Fuller's Earth, Hectorite, Kaolin, Montmorillonite, Pyrophyllite, and Zeolite. These ingredients are termed silicates because they contain silicon, oxygen, and one or more metals. Many silicates occur naturally and are mined; yet others are made synthetically.

Typical cosmetic uses of silicates include abrasive, opacifying agent, viscosity-increasing agent, anticaking agent, emulsion stabilizer, binder, and suspending agent. Clay silicates (silicates containing water in their structure) primarily function as adsorbents, opacifiers, and viscosity-increasing agents. Pyrophyllite is also used as a colorant. Current concentrations of use range from as low as 0.01% for Zeolite to a high of 84% for Kaolin. Some ingredients with no uses reported to FDA in 1998 have current concentrations of use reported by the industry, so it is assumed they are in use.

Aluminum Silicate is approved as an indirect food additive in the Code of Federal Regulations (21 CFR 177.2600 and 21 CFR 177.1200). VEEGUM, a tradename for Magnesium Aluminum Silicate, has been designated by the FDA as a raw material with the following number: FD CRMCS no. R0010045 and has an individual Chemical Abstract Registry number, 12199-37-0. According to the European Cosmetic Directive (EU reference no. 391 Annex II), zirconium and its compounds are listed under substances that must not form part of the composition of cosmetic products, with the exception of complexes in Annex III, Part I. IARC has ruled Attapulgit fibers $>5 \mu\text{m}$ as group 2B, *possibly carcinogenic to humans*, and fibers $<5 \mu\text{m}$ as group 3, *not classified as to their carcinogenicity to humans* (IARC 1997). Bentonite is considered GRAS as a direct food additive (21 CFR 184.1155). Kaolin is considered GRAS as an indirect

food additive (21 CFR 186.1256). Pyrophyllite is listed as a naturally occurring color additive in the Code of Federal Regulations (21 CFR 73.1400). The natural Zeolites (Clinoptilolite, Phillipsite, Mordenite, Nonfibrous Japanese Zeolite) and synthetic Zeolites *cannot be classified as to their carcinogenicity to humans* (group 3) according to IARC (1997). Calcium Silicate, Magnesium Aluminum Silicate, Magnesium Trisilicate, Attapulgit, Hectorite, and Kaolin are all used in over-the-counter products.

Hectorite and Montmorillonite catalyzed glycine and diglycine oligomerization reactions; oligomers were formed by self-condensation of both purines and pyrimidines in the presence of Montmorillonite treated with Na^+ . Under UV light, adenosine monophosphate molecules were absorbed onto Kaolin and the products were hydrolyzed by phosphodiesterase.

All silicates have the great ability to absorb, especially the clays. Reports describe drugs, bacteria, viruses, and toxins absorbed to clays due to the physical structure of clays and their cationic nature.

No statistically significant absorption of aluminum and elevated levels of silicon were recorded in assayed plasma samples of dogs given Magnesium Trisilicate and Zeolite orally. The urinary excretion of silica was 5.2% in males given 20 g of Magnesium Trisilicate. Ten percent Bentonite in the diets of rats overcame T-2 toxicosis completely. Various Zeolites were added to the diets of pigs. No adverse effects were noted by the supplementation.

A sample of Aluminum Silicate was toxic to pulmonary alveolar macrophages and LDH activity and β -GAL release were increased. Aluminum Silicate had relatively no effect on the hemolysis of rat RBCs. Synthetic Calcium Silicate samples and higher concentrations of Calcium Silicate caused increased hemolysis of human RBCs; a greater fibrous character of Calcium Silicate samples caused increased LDH and β -GAL release. Many clays (Attapulgit, Bentonite, Hectorite, Kaolin, Montmorillonite, Pyrophyllite, and Zeolite) demonstrated cytotoxicity to several macrophage type cell lines and have hemolytic activity towards several species' RBCs. Particle size, fibrogenicity, concentration, and mineral composition had the greatest effect on toxicity. Larger particle size and longer and wider fibers cause more adverse effects. In most of the studies, a dose-dependent effect on cytotoxicity or lysis was observed. Most mineral samples were not 100% pure and many samples already contained toxic dusts or minerals like quartz or cristobalite.

The following are a list of acute oral LD_{50} determinations: Calcium Silicate, 3400 mg/kg in rats; Magnesium Aluminum Silicate, 50000 mg/kg in mice; Zirconium Silicate, >200 g/kg in mice; Hectorite, >5 g/kg in rats; Kaolin, 149 g/kg in rats (death due to bowel obstruction); 15 natural Zeolites, 10 g/kg in rats. In short-term oral toxicity studies, no adverse effects were seen in mice or rabbits dosed up to 5 g/kg Magnesium Aluminum Silicate; beagle dogs and rats fed Aluminum Silicate had no renal lesions. Dogs and rats fed Magnesium Trisilicate for 4 weeks had polydypsia and polyuria, and all dogs had renal

cortical lesions. Guinea pigs had renal lesions after 4 months of drinking Magnesium Trisilicate in their tap water. Rats fed 10% Magnesium Aluminum Silicate had slightly elevated silicon levels of the spleen and dogs and rats fed 10% VEEGUM had no negative responses in 90-day feeding studies. No lesions were found in rats dosed up to 1000 mg/kg for 104 weeks.

The following results are from acute parenteral injection studies. Intratracheal injections of Aluminum Silicate caused lesions in a dose-dependent manner and the intrapleural injections of four different Aluminum Silicate samples all resulted in lesions. One aluminosilicate injection caused three malignant mesotheliomas, one pleural and two peritoneal. No mesotheliomas developed in rats injected intraperitoneally with 25 mg of Calcium Silicate dust. Subcutaneous injection into the oral mucosa and into the back, periosteal injections into periosteal tissue, and intramuscular injections into the thigh of rats and guinea pigs with Zirconium Silicate resulted in mild inflammatory reactions. Attapulgit was injected intraperitoneally, intrapleurally, and intratracheally in various studies. Most studies reported that lesions and mesotheliomas were dependent on fiber length. Samples with a longer length caused greater numbers of mesotheliomas. Subplantar injections of Bentonite caused granulomas. Intratracheal injections of Bentonite and group C *Streptococcus* species caused an 85% mortality compared to a 5% control mortality in mice; another intratracheal injection caused loose reticulin fibrils with no collagen. Kaolin injected with the *Streptococcus* species caused statistically significant but modest mortality in mice. In a series of intrapleural injections, Kaolin was used as a negative control. Heat treated Montmorillonite dosed to rats by means of intratracheal instillation was restricted to alveoli within and adjacent to alveolar ducts. Minor inflammatory reactions, but no lesions, were found in rats given intratracheal injections of Clinoptilolite, and intraperitoneal injections of Mordenite, Synthetic Zeolite 4A, and synthetic Zeolite MS5A (one mesothelioma was seen in rats given MS4A). An intrapleural injection of Nonfibrous Japanese Zeolite caused two mesotheliomas in rats.

Small primary neoplastic lesions were found in two rats exposed to a Calcium Silicate sample in an inhalation chamber. The mass of silicate measured in the lungs ranged from 0.1 to 0.8 mg. Lebrija and Leichester Attapulgit samples caused one peritoneal mesothelioma, one adenocarcinoma, and three bronchoalveolar hyperplasia and two mesotheliomas, one peritoneal mesothelioma, one malignant alveolar tumor and eight bronchoalveolar hyperplasia (inhalation route) in rats, respectively. Both samples contained long fibers. Moderate to extensive respiratory disease was noted in rats chronically exposed to Synthetic Zeolite A by inhalation methods.

The acute dermal LD_{50} was >3.5 g/kg for rabbits exposed to VEEGUM. Magnesium Aluminum Silicate (4%) was a weak primary skin irritant in rabbits and had no cumulative skin irritation in guinea pigs. No gross effects were reported in any of these studies. Sodium Magnesium Silicate (4%) had no primary skin irritation in rabbits and had no cumulative skin irritation in

guinea pigs. Hectorite was nonirritating to the skin of rabbits in a Draize primary skin irritation study.

A 4% solution of Magnesium Aluminum Silicate and a 4% solution of Sodium Magnesium Silicate caused minimal eye irritation in a Draize eye irritation test. Bentonite caused severe iritis after injection into the anterior chamber of the eyes of rabbits. When injected intralaminally, widespread corneal infiltrates and retrocorneal membranes were recorded. In a primary eye irritation study in rabbits, Hectorite was moderately irritating without washing and practically nonirritating to the eye with a washout. Rats tolerated a single dose of Zeolite A without any adverse reaction in the eye.

Calcium Silicate (250 to 1600 mg/kg) had no discernible effect on nidation or on maternal or fetal survival in rabbits. Magnesium Aluminum Silicate (6000 mg/kg) had neither a teratogenic nor adverse effects on the mouse fetus. Female rats receiving a 20% Kaolin diet exhibited maternal anemia but no significant reduction in birth weight of the pups was recorded. Type A Zeolite produced no adverse effects on the dam, embryo, or fetus in either rats or rabbits at any dose level (74 or 1600 mg/kg). Clinoptilolite had no effect on female rat reproductive performance.

No increase mutation frequencies were seen in the *Salmonella* TA-1530 or G-46 assay and no significant increase in recombinant activity in the *Saccharomyces* D3 assay treated with Calcium Silicate. A subacute dose of 150 mg/kg of Calcium Silicate produced 3% breaks in bone marrow cells arrested in c-metaphase. In a metaphase spread of bone marrow cells, Calcium Silicate produced no significant increase in the number of aberrations compared to controls and in a dominant lethal assay did not induce any dominant lethal mutations. In the *S. typhimurium* LT2 spot test (TA98, TA100, TA1535, TA1537, and TA1538) with or without metabolic activation, Magnesium Aluminum Silicate and Hectorite were found nonmutagenic. In primary hepatocyte cultures, the addition of Attapulgite had no significant unscheduled DNA synthesis (UDS) response or modulated response to AAF (a positive control); Attapulgite at 10 $\mu\text{g}/\text{cm}^2$ caused significant increases in UDS in rat pleural mesothelial cells. Zeolite particles (<10 μm) produced statistically significant increase in the percentage of aberrant metaphases, mostly chromatid breaks.

Applications of 2 g of VEEGUM made to the skin of two humans daily for 1 week caused no effects.

Occupational exposure to mineral dusts has been studied extensively. Fibrosis and pneumoconiosis has been documented in workers involved in the mining and processing of Aluminum Silicate, Calcium Silicate, Zirconium Silicate, Fuller's Earth, Kaolin, Montmorillonite, Pyrophyllite, and Zeolite.

DISCUSSION

The CIR Expert Panel determined that the data provided in this report are sufficient to assess the safety of the tested ingredients: Aluminum Silicate, Calcium Silicate, Magnesium Alu-

minum Silicate, Magnesium Silicate, Magnesium Trisilicate, Sodium Magnesium Silicate, Zirconium Silicate, Attapulgite, Bentonite, Fuller's Earth, Hectorite, Kaolin, Lithium Magnesium Silicate, Lithium Magnesium Sodium Silicate, Montmorillonite, Pyrophyllite, and Zeolite. The Panel did note a concern about inhalation of these ingredients due to reported cases of pneumoconiosis and fibrosis in humans and pulmonary lesions in animals. However, extensive pulmonary damage in humans was the result of direct occupational inhalation of the dusts and lesions seen in animals were affected by particle size, fiber length, and concentration. The Panel recognizes that most of the formulations are not respirable and of the preparations that are respirable, the concentration of the ingredient is very low. Even so, the Panel considered that any spray containing these solids should be formulated to minimize their inhalation.

Note: The cosmetic ingredient, *Talc*, is a hydrated magnesium silicate with the chemical composition of $\text{Mg}_3\text{Si}_4\text{O}_{10}(\text{OH})_2$. Talc occurs in various forms and has a unique crystalline structure which differs from ingredients addressed in this safety assessment. Talc is not included in this report.

CONCLUSION

The CIR Expert Panel concludes that Aluminum Silicate, Calcium Silicate, Magnesium Aluminum Silicate, Magnesium Silicate, Magnesium Trisilicate, Sodium Magnesium Silicate, Zirconium Silicate, Attapulgite, Bentonite, Fuller's Earth, Hectorite, Kaolin, Lithium Magnesium Silicate, Lithium Magnesium Sodium Silicate, Montmorillonite, Pyrophyllite, and Zeolite are safe as used in cosmetic products.

REFERENCES

- Adachi, S., K. Kawamura, S. Yoshida, and K. Takemoto. 1992. Oxidative damage on DNA induced by asbestos and man-made fibers in vitro. *Int. Arch. Occup. Environ. Health* 63:553-557.
- Adamis, Z., M. Timar, L. Koefler, E. Tatari, and G. Ungari. 1986. Biological effects of the respirable dusts from ore mines. *Environ. Res.* 41:319-326.
- Akers, M. J., J. L. Lach, and L. J. Fischer. 1973. Alterations in adsorption of dicumarol by various excipient materials. *J. Pharm. Sci.* 62:391-395.
- American Conference on Governmental Industrial Hygienists (ACGIH). 1997. *Threshold limit values and biological exposure indices for 1997*. Cincinnati, OH: ACGIH.
- American Minerals, Inc. 1998. Material safety data sheet on zirconium silicate. Unpublished data submitted by CTFA. 4 pages.²
- Angino, E. E. 1964. Far-infrared spectra of montmorillonite, kaolin, and illite. *Nature* 204:569-571.
- Armstrong, N. A., and C. D. Clarke. 1971. The adsorption of crystal violet by Kaolin. *J. Pharm. Pharmacol.* 23:95S-100S.
- Austin, P. S., and D. J. Doughman. 1980. Reaction to introcular penetration of bentonite. *Am. J. Ophthalmol.* 89:719-723.
- Babhair, S. A., and M. Tariq. 1983. Effect of magnesium trisilicate and kaolin-pectin on the bioavailability of trimethoprim. *Res. Commun. Chem. Pathol. Pharmacol.* 40:165-168.

² Available for review: Director, Cosmetic Ingredient Review, 1101 17th Street, NW, Suite 310, Washington, DC 20036-4702, USA.

- Banin, E., and H. Meiri. 1990. Toxic effects on aluminosilicates on nerve cell. *Neuroscience* 39:171–178.
- Barr, M. 1963. General characteristics and applications of the montmorillonite hydrocolloids. *Am. Perfumer Cosmet.* 78:2–37.
- Barr, M., and E. S. Armista. 1957. Adsorption studies on clay I. The adsorption of two alkaloids by activated attapulgite, halloysite, and kaolin. *J. Am. Pharm. Assoc.* 46:486–489.
- Bartko, P., L. Vrgula, M. Prosova, and J. Blazovsky. 1983. The effect of the administration of zeolite (clinoptilolite) on the health condition of sheep. *Vet. Med.* 28:481–492.
- Beck, E. G., and J. Bignon, eds. 1985. *In vitro effects of mineral dusts*. NATO ASI Series, vol. G3. Berlin: Springer-Verlag.
- Be'gin, R., S. Masse, M. Rola-Pleszczynski, M. Geoffroy, M. Martel, Y. Desmarais, and P. Sebastien. 1987. The lung biological activity of American attapulgite. *Environ. Res.* 42:328–339.
- Belmonte, A. A. 1994. Bentonite. In *Handbook of Pharmaceutical Excipients*, 2nd ed., ed. A. Wade and P. J. Weller, 24–26. Washington, DC: American Pharmaceutical Association.
- Benke, G. M., and T. W. Osborn. 1979. Urinary silicon excretion by rats following oral administration of silicon compounds. *Food Cosmet. Toxicol.* 17:123–127.
- Beveridge, A., and W. F. Pickering. 1983. The influence of surfactants on the adsorption of heavy metal ions by clays. *Water Res.* 17:215–226.
- Bish, D. L., and G. D. Guthrie Jr. 1993. Mineralogy of clay and zeolite dusts (exclusive of 1:1 layer silicates). In *Reviews in mineralogy, vol. 28, Health effects of mineral dusts*, ed. G. D. Guthrie Jr., and B. T. Mossman, 163–181. Chelsea, MI: Brook Crafters.
- Blevins, R. D., and D. E. Taylor. 1982. Mutagenicity screening of twenty-five cosmetic ingredients with salmonella/microsome test. *J. Environ. Sci. Health Part A* 17:217–239.
- Bolton, R. E., J. Addison, M. G. Davis, K. Donaldson, A. D. Jones, B. G. Miller, and A. Wright. 1986. Effects of the inhalation of dusts from calcium silicate insulation materials in laboratory rats. *Environ. Res.* 39:26–43.
- Brouillard, M. Y., and J. G. Rateau. 1989. Adsorption potency of 2 clays, smectite and kaolin on bacterial endotoxins. In vitro study in cell culture and the intestine of newborn mice. *Gastroenterol. Clin. Biol.* 13:18–24.
- Brown, R. C., M. Chamberlain, R. Davies, and G. T. Sutton. 1980. The in vitro activities of pathogenic mineral dusts. *Toxicology* 17:143–147.
- Browne, J. E., J. R. Feldkamp, J. L. White, and S. L. Hem. 1980. Characterization and adsorptive properties of pharmaceutical grade clays. *J. Pharm. Sci.* 69:816–823.
- Budavari, S., ed. 1989. *The Merck index. An encyclopedia of chemicals, drugs, and biologicals*, 11th ed. Rahway, NJ: Merck & Co.
- Bujdak, J., and B. M. Rode. 1996. The effect on smectite composition on the catalysis of peptide bond formation. *J. Mol. Evol.* 43:326–333.
- Butz, W. C. 1970. Disseminated magnesium and aluminum silicate associated with paregoric addiction. *J. Forensic Sci.* 15:581–587.
- Carlson, B. C. 1977. Veegum in cosmetic gels and sticks. *Cosmet. Toilettries* 92:81–86.
- Carroll, D. 1959. Ion exchange in clays and other minerals. *Bull. Geol. Soc. Am.* 70:749–780.
- Carson, M. S., and T. K. Smith. 1982. Effect of non-nutritive mineral additives and fibers on T-2 toxicosis in male weanling rats. *J. Animal Science* 53:284.
- Carson, M. S., and T. K. Smith. 1983. Role of bentonite in prevention of T-2 toxicosis in rats. *J. Anim. Sci.* 57:1498–1506.
- Casey, K. R., J. W. Shigeoka, W. N. Rom, and F. Moatamed. 1985. Zeolite exposure and associated pneumoconiosis. *Chest* 87:837–840.
- Cefali, E. A., J. C. Nolan, W. R. McConnell, and D. L. Walters. 1995. Pharmacokinetic study of zeolite A, sodium aluminosilicate, magnesium silicate and aluminum hydroxide in dogs. *Pharm. Res.* 12:270–274.
- Cefali, E. A., J. C. Nolan, W. R. McConnell, and D. L. Walters. 1996. Bioavailability of silicon and aluminum from zeolite A in dogs. *Int. J. Pharm.* 127:147–154.
- Chamberlain, M., R. Davies, R. C. Brown, and D. M. Griffiths. 1982. In vitro tests for the pathogenicity of mineral dusts. *Ann. Occup. Hyg.* 26:583–592.
- Churg, A. 1983. Nonasbestos pulmonary mineral fibers in the general population. *Environ. Res.* 31:189–200.
- Coffin, D. L., P. M. Cook, and J. P. Creason. 1992. Relative mesotheliomas induction in rats by mineral fibers: Comparison with residual pulmonary mineral fiber number and epidemiology. *Inhal. Toxicol.* 4:273–300.
- Cosmetics Directive of the European Union. 1995. Updated version—Incorporating all amendments until August 1, 1995. Dir 76/768EEC, Annex III, 12.
- Cosmetic Ingredient Review (CIR). 1980. Final report on the safety assessment of Quaternium-18 Hectorite, Quaternium-18, and Quaternium-18 Bentonite. Washington: CIR. 25 pages.²
- Cosmetic, Toilettry, and Fragrance Association (CTFA). 1970a. Safety data of magnesium aluminum silicate. Unpublished data submitted by CTFA. 4 pages.²
- CTFA. 1970b. Safety data of Sodium Magnesium Silicate. Unpublished data submitted by CTFA. 4 pages.²
- CTFA. 1999a. Concentrations of use of cosmetic ingredients. Unpublished data submitted by CTFA.²
- CTFA 1999b. VEEGUM is nontoxic and nonirritating. Unpublished data submitted by CTFA. 1 page.²
- Davies, R., D. M. Griffiths, N. F. Johnson, A. W. Preece, and D. C. Livingston. 1984. The cytotoxicity of kaolin toward macrophages in vitro. *Br. J. Exp. Pathol.* 65:453–466.
- Davies, R., and A. W. Preece. 1983. The electrophoretic mobilities of minerals determined by laser Doppler velocimetry and their relationship with the biological effect of dusts toward macrophages. *Clin. Phys. Physiol. Meas.* 4:129–140.
- Denizeau, F. M., G. Marion, G. Chevalier, and M. G. Cote. 1985a. Ultrastructural study of mineral fiber uptake by hepatocytes in vitro. 26:119–126.
- Denizeau, F. M., G. Marion, G. Chevalier, and M. G. Cote. 1985b. Absence of genotoxic effects of nonasbestos mineral fibers. *Cell Biol. Toxicol.* 1:23–32.
- Ditter, B., R. Urbaschek, and B. Urbaschek. 1983. Ability of various adsorbents to bind endotoxins in vitro and to prevent orally induced endotoxemia in mice. *Gastroenterology* 84:1547–1552.
- Dobbie, J. W., and M. J. Smith. 1982. Silicate nephrotoxicity in the experimental animal: The missing factor in analgesic nephropathy. *Scot. Med. J.* 27:10–16.
- Dougherty, S. H., V. D. Fiegel, R. D. Nelson, G. T. Rodeheaver, and R. L. Simmons. 1985. Effects of soil infection potentiating factors on neutrophils in vitro. *Am. J. Surg.* 150:306–311.
- Drachman, S. R., G. E. Roch, and M. E. Smith. 1997. Solid state NMR characterization of the thermal transformation of Fuller's Earth. *Solid State Nucl. Magn. Reson.* 9:257–267.
- Drucker, M. M., J. Goldhar, P. L. Ogra, and E. Neter. 1977. The effect of attapulgite and charcoal on enterotoxicity of *Vibrio cholerae* and *Escherichia coli* enterotoxins in rabbits. *Infection* 5:211–213.
- Durnev, A. D., N. O. Dauge-Dauge, L. G. Korkina, and S. B. Seredenin. 1993. Peculiarities of the clastogenic properties of chrysotile-asbestos fibers and zeolite particles. *Mutat. Res.* 319:303–308.
- Dvora'k, M. 1989. Ability of bentonite and natural zeolite to absorb aflatoxin from liquid media. *Vet. Med. (Praha.)* 34:307–316.
- Edwards, M. S., M. S. Harrison, M. R. Jalks-Miller, N. Nakayama, M. S. Berger, and D. H. Glick. 1984. Kaolin-induced congenital hydrocephalus in utero in fetal lambs and rhesus monkeys. *J. Neurosurg.* 60:115–122.
- El-Nakeeb, M. A., and R. T. Youssef. 1968. Influence on various materials in antibiotics in liquid pharmaceutical preparations. *Acta. Pharm.* 5:1–8.
- Englemard. 1998. Dear customer letter re fiber length for Englehard attapulgite products. Unpublished data submitted by Englehard Corporation. 1 page.²
- Ertem, G., and J. P. Ferris. 1998. Formation of RNA oligomers on montmorillonite site of catalysis. *Orig. Life Evol. Biosph.* 28:485–499.
- Evcm, N., and M. Barr. 1955. Adsorption of some alkaloids by different clays. *J. Am. Pharm. Assoc. Sci. Edn.* 44:570–573.
- Federation of American Societies for Experimental Biology. 1977. Evaluation of the health aspects of bentonite and clay(kaolin) as food ingredients. NTIS report No. PB276416.

- Ferreira, J. M., and Y. M. Freitas. 1976. Microbiological surveys of talcum powders and raw materials. *Cosmet. Toiletries* 91:19–26.
- Ferris, J. P., A. R. Hill, R. Liu, and L. E. Orgel. 1996. Synthesis of long prebiotic oligomers on mineral surfaces. *Nature* 381:59–61.
- Food and Drug Administration (FDA). 1984. Cosmetic product formulation and frequency of use data. Washington, DC: FDA.
- FDA. 1994. *OTC Drug Review Ingredient Status Report*. September 1, 1994.
- FDA. 1998. Frequency of use of cosmetic ingredients. *FDA database*. Washington, DC: FDA.
- Food and Drug Research Labs. (FDRL), Inc. 1958a. 90-Day feeding study using rats. Unpublished data submitted by R. T. Vanderbilt Co., Inc. 16 pages.²
- FDRL, Inc. 1958b. 90-Day feeding study using dogs. Unpublished data submitted by R. T. Vanderbilt Co., Inc. 7 pages.²
- FDRL, Inc. 1973. Tetraologic evaluation of FDA 71-41 (hydrated calcium silicate). NTIS report No. PB223829.
- FDRL, Inc. 1980a. Primary skin irritation study in rabbits. Unpublished data submitted by Rheox, Inc. 9 pages.²
- FDRL, Inc. 1980b. Acute oral toxicity in rats study. Unpublished data submitted by Rheox, Inc. 12 pages.²
- FDRL, Inc. 1981. Primary eye irritation study with hectorite. Unpublished data submitted by Rheox, Inc. 15 pages.²
- Fugiyoshi, T., I. Hayashi, and S. Oh-ishi. 1989. Kaolin-induced writhing response in mice activation of the plasma kallidrein-kinin system by kaolin. *J. Pharmacobiol. Dyn.* 12:483–487.
- Gamble, J. F. 1986. Silicate pneumoconiosis. In *Occupational respiratory diseases*, ed. J. A. Merchant, NIOSH publication no. 86–102.
- Gantzer, C., F. Quignon, and L. Schwartzbrod. 1994. Poliovirus-1 adsorption onto and desorption from montmorillonite in seawater. survival of the adsorbed virus. *Environ. Technol.* 15:271–278.
- Garcia, J. G. N., R. F. Dodson, and D. S. Callahan. 1989. Effect of environmental particulates on cultured human and bovine endothelium. *Lab. Invest.* 61:53–61.
- Ghazy, F. S., A. A. Kassem, and S. H. Shalaby. 1984. Adsorption characteristics of certain antibiotics to Veegum and a charcoal. *Pharmazie* 39:821–823.
- Gibbs, A. R., and F. D. Pooley. 1994. Fuller's earth (montmorillonite) pneumoconiosis. *Occup. Environ. Med.* 51:644–646.
- Gormley, I. P., and J. Addison. 1983. The in vitro toxicity of some standard clay mineral dusts of respirable size. *Clay Minerals* 18:153–163.
- Gormely, I. P., M. J. Kowolik, and R. T. Cullen. 1985. The chemiluminescent response of human phagocytic cells to mineral dusts. *Br. J. Exp. Pathol.* 66:409–416.
- Gamble, J. F. 1986. *Silicate pneumoconiosis. Occupational respiratory diseases*, ed. J. A. Merchant, 243–285. Appalachian Laboratory for Occupational Safety and Health (NIOSH), U.S. Department of Health and Human Services, DHHS (NIOSH), Publication no. 86-102.
- Glohuber, C., M. Potokar, W. Pittermann, S. Wallat, F. Bartnik, H. Reuter, and S. Braig. 1983. Zeolite A—a phosphate substitute for detergents: Toxicological investigation. *Food Chem. Toxicol.* 21:209–220.
- Grim, R. E., ed. 1972. *Clay mineralogy*, 2nd ed. New York: McGraw-Hill Book Co.
- Hale, L. W., J. Gough, E. J. King, G. Nagelschmidt. 1956. Pneumoconiosis of kaolin workers. *Br. J. Ind. Med.* 13:251–259.
- Hansen, D., and B. T. Mossman. 1987. Generation of superoxide formation (O₂⁻) from alveolar macrophages exposed to asbestiform and nonfibrous particles. *Cancer Res.* 47:1681–1686.
- Harding, H. E. 1948. The toxicology of Zircon: Preliminary report. *Br. J. Ind. Med.* 5:73–76.
- Harvey, G., M. Page, and L. Dumas. 1984. Binding of environmental carcinogens to asbestos and mineral fibers. *Br. J. Ind. Med.* 41:396–400.
- Hatch, G. E., E. Boykin, J. A. Graham, J. Lewtas, F. Pott, K. Loud, and J. L. Mumford. 1985. Inhalable particles and pulmonary host defense: *In vivo* and *in vitro* effects of ambient air and combustion particles. *Environ. Res.* 36:67–80.
- Hazelton Laboratories, Inc. 1968. Acute ocular and dermal testing with magnesium aluminum silicate. Unpublished data submitted by R. T. Vanderbilt Co., Inc. 17 pages.²
- Healy, D. P., A. B. Dansereau, A. B. Dunn, C. E. Clenedning, A. W. Mounts, and G. S. Deepe Jr. 1997. Reduced tetracycline bioavailability caused by magnesium aluminum silicate in liquid form of bismuth subsalicylate. *Ann. Pharmacother.* 31:1460–1464.
- Herman, S. J., G. C. Olscamp, and G. L. Weisbord. 1982. Pulmonary kaolin granulomas. *J. Can. Assoc. Radiol.* 33:279–280.
- Hevlin, F. G., and Murray, H. H. 1994. Clays. Hormites: palygorskite (attapulgite) and sepiolite. In *Industrial minerals and rocks*, 6th ed., ed. D. D. Carr, 159–173. Littleton, CO: Society for Mining, Metallurgy, and Exploration.
- Hunt, H., F. D. Pooley, and R. J. Richards. 1981. Biological activity of calcium silicate composites-in vitro studies. *Environ. Res.* 26:51–68.
- International Agency for Research on Cancer (IARC). 1997. *IARC monographs on the evaluation of carcinogenic risks of chemicals to humans. Silica and some silicates*, vol. 47. Lyon, France: IARC.
- Informatics, Inc. 1974. Scientific literature reviews on generally recognized as safe (GRAS) food ingredients—bentonite and clay. NTIS report no. PB234893.
- Inveresk Research International. 1995. Mutagenicity assay of hectorite with five strains of *S. typhimurium* bacteria. Unpublished data submitted by Rheox, Inc. 40 pages.²
- Jaurand, M. C., J. Fleury, G. Monchaux, M. Nebut, and J. Bignon. 1987. Pleural carcinogenic potency of mineral fibers asbestos attapulgite and their cytotoxicity in cultured cells. *J. Natl. Cancer Inst.* 79:797–804.
- Keeting, P. E., M. J. Oursler, K. E. Wiegand, S. K. Bonde, T. C. Spelsberg, and B. L. Riggs. 1992. Zeolite A increases proliferation, differentiation, and transforming growth factor production in normal adult human osteoblast-like cells in vitro. *J. Bone Min. Res.* 7:1281–1289.
- Keller, W. D. 1979. Clays. In *Kirk-Othmer encyclopedia of chemical technology*, vol. 6, 3rd ed., ed. M. Grayson, 202. New York: John Wiley & Sons.
- Kelse, J. W. 1997. Crystalline silica risk information. Unpublished data submitted by R. T. Vanderbilt Co., Inc. 14 pages.²
- Khali, S. A. H., L. M. Mortada, and M. El-Khawas. 1984a. Uptake of ampicillin and amoxycillin by some adsorbents. *Int. J. Pharm.* 18:157–167.
- Khali, S. A. H., L. M. Mortada, and M. El-Khawas. 1984b. Decreased bioavailability of ampicillin and amoxycillin in presence of kaolin. *Int. J. Pharm.* 19:233–238.
- Kleber, C. J., and M. S. Putt. 1986. Plaque removal by chewing gum containing zirconium silicate. *Compend. Contin. Educ. Dent.* 7:681–685.
- Korkina, L. G., T. B. Suslova, S. I. Nikolova, G. N. Kirov, and B. T. Velichkovsky. 1984. The mechanism of cytotoxic action of the natural zeolite clinoptilolite. *Farmakol. Toksikol.* 47:63–67.
- Kruglikov, G. G., B. T. Velichkovsky, and T. I. Garmash. 1990. Morphology of pneumoconiosis induced with the natural zeolite. *Gig. Tr. prof. Zabol.* 5:14–17.
- Kruglikov, G. G., B. T. Velichkovsky, T. I. Garmash, and V. M. Volkogonova. 1992. Functional and structure changes in macrophages of lungs during the phagocytosis of the natural zeolite clinoptilolite. *Gig. Tr. prof. Zabol.* 11–12:44–46.
- Kukita, T., A. Yamaguchi, A. Okamoto, and M. Nemoto. 1992. Interaction between polyethylene films and bromohexine HCL in solid dosage form. IV. Prevention of the sorption by the addition of magnesium aluminum silicate. *Chem. Pharm. Bull. (Tokyo)* 40:1257–560.
- Lachapelle, J. M. 1984. Occupational airborne irritant contact reaction to the dust of a food additive. *Contact Dermatitis* 10:250–254.
- Lapenas, D. J., and P. N. Gale. 1983. Kaolin pneumoconiosis. A case report. *Arch. Pathol. Lab. Med.* 107:650–653.
- Lapenas, D. J., P. Gale, T. Kennedy, W. Rawlings, and P. Dietrich. 1984. Kaolin pneumoconiosis: Radiological, pathological, and mineralogical findings. *Am. Rev. Respir. Dis.* 130:282–288.

- Lee, M. H., Y. H. Lee, T. H. Hsu, M. T. Chen, and L. Chang. 1993. Silica stone development due to long time oral trisilicate intake. *Am. J. Ind. Med.* 27:267-269.
- Lemaire, I. 1991. Selective differences in macrophage populations and monokine production in resolving pulmonary granuloma and fibrosis. *Am. J. Pathol.* 138:487-495.
- Lemaire, I., P. G. Dionne, D. Nadeau, and J. Dunnigan. 1989. Rat lung reactivity to natural and man-made fibrous silicates following short-term exposure. *Environ. Res.* 48:193-210.
- Levin, J. L., A. L. Frank, M. G. Williams, et al. 1996. Kaolinosis in a cotton mill worker. *Am. J. Ind. Med.* 29:215-221.
- Lewis, R. J., Sr. 1993. *Hawley's condensed chemical dictionary*, 12th ed. New York: van Nostrand Reinhold.
- Lide, D. R., ed. 1993. *CRC handbook of chemistry and physics*, 74th ed. Boca Raton, FL: CRC Press, Inc.
- Lippo, K. K., A. L. Antila, O. Taikina-Aho, et al. 1993. Hypersensitivity pneumonitis and exposure to zirconium silicate in a young ceramic tile worker. *Am. Rev. Respir. Dis.* 148:1089-1092.
- Lipson, S. M., and G. Stotzky. 1984. Effect of proteins on reovirus adsorption to clay minerals. *Appl. Environ. Microbiol.* 48:525-530.
- Lipson, S. M., and G. Stotzky. 1985. Specificity of virus adsorption to clay minerals. *Can. J. Microbiol.* 31:50-53.
- Litton Bionetics, Inc. 1974. Mutagenic evaluation of Compound FDA 71-41, calcium silicate. NTIS report No. PB245457.
- Lynch, K. M., C. V. Harrison, and G. Nagelschmidt. 1954. Pneumoconiosis from exposure to kaolin dust: kaolinosis. *Am. J. Pathol.* 30:1117-1122.
- Maltoni, C., and F. Minardi. 1988. First available results of long-term carcinogenicity bioassay on tergency zeolites (MS 4A and MS 5A). In *Living in a Chemical World*, vol. 534, ed. C. Maltoni and I. J. Selikoff, 978-985. New York: New York Academy of Sciences.
- M'anyai, S., J. Kabai, J. Kis, E. Suveges, and M. Timar. 1969. The in vitro hemolytic effect of various clay minerals. *Med. Lav.* 60:331-342.
- M'anyai, S., J. Kabai, J. Kis, E. Suveges, and M. Timar. 1970. The effect of heat treatment on the surface of kaolin and its in vitro hemolytic activity. *Environ. Res.* 3:187-198.
- Marek, J., and V. Blaha. 1985. Some methodological and morphological aspects of bentonite-induced inflammatory reaction in the rat. *Acta Univ. Palacke Olkumc. Fac. Med.* 108:151-170.
- Martin, J. C., H. Daniel, and L. Le Bouffant. 1975. Short-term and long-term experimental study of the toxicity of coal-mine dust and its constituents. *Inhal. Part.* 4:361-371.
- McClurg, H. J., R. D. Beck, and P. Powers. 1980. The effect of a kaolin-pectin adsorbent on stool losses of sodium, potassium, and fat during a lactose-intolerance diarrhea in rats. *J. Pediatr.* 96:769-771.
- McCullum, F. T., and M. L. Galyean. 1983. Effects of clinoptilolite on rumen fermentation, digestion and feedlot performance in beef steers fed high concentrate diets. *J. Anim. Sci.* 56:517-524.
- McGinity, J. W., and J. L. Lach. 1976. In vitro adsorption of various pharmaceuticals to montmorillonite. *J. Pharm. Sci.* 65:896-902.
- Morgan, W. K., A. Donner, I. T. T. Higgins, et al. 1988. The effects of kaolin on the lung. *Am. Rev. Respir. Dis.* 138:813-820.
- Mossman, B. T., and R. O. Be'gin, eds. 1989. *In vitro effects of mineral dusts*. NATO ASI Series, vol. H30. Berlin: Springer-Verlag.
- Mossman, B. T., and J. E. Craighead. 1982. Comparative carcinogenic effects of crocidolite asbestos, hematite, kaolin, and carbon in implanted tracheal organ cultures. *Ann. of Occup. Hyg.* 26:553-567.
- Munch, J. C. 1944. Oral and dermal toxicity studies on VEEGUM. Unpublished data submitted by R. T. Vanderbilt Co., Inc. 2 pages.²
- Munch, J. C. 1945. Toxicity report on VEEGUM using mice and rabbits. Unpublished data submitted by R. T. Vanderbilt Co., Inc. 2 pages.²
- Murphy, E. J., E. Roberts, D. K. Anderson, and L. A. Horrocks. 1993b. Cytotoxicity of aluminum silicate in primary neuronal cultures. *Neuroscience* 57:483-490.
- Murphy, E. J., E. Roberts, and L. A. Horrocks. 1993a. Aluminum silicate toxicity in cell cultures. *Neuroscience* 55:597-605.
- Musk, A. W., B. D. Beck, H. W. Greville, J. D. Brain, and D. E. Böhannon. 1988. Pulmonary disease from exposure to an artificial aluminum silicate: further observations. *Br. J. Ind. Med.* 45:246-250.
- Musk, A. W., H. W. Greville, and A. E. Tribe. 1980. Pulmonary disease from occupational exposure to an artificial aluminum silicate used for cat litter. *Br. J. Ind. Med.* 34:367-372.
- Nadeau, D., L. Fouquette-Couture, D. Paradis, J. Khorami, D. Lane, and J. Dunnigan. 1987. Cytotoxicity of respirable dusts from industrial minerals: comparison of two naturally occurring and two man-made silicates. *Drug Chem. Toxicol.* 10:40-86.
- National Academy of Sciences. 1996. *Food chemicals codex*, 4th ed. Washington, DC: National Academy Press.
- Nikitakis, J. M., and G. N. McEwen Jr., eds. 1990a. *CTFA compendium of cosmetic ingredient composition—Specifications*. Washington, DC: CTFA.
- Nikitakis, J. M., and G. N. McEwen Jr., eds. 1990b. *CTFA Compendium of Cosmetic Ingredient Composition—Descriptions I and II*. Washington, DC: CTFA.
- Nolen, G. A., and T. A. Dickerman. 1983. Test for aluminosilicate teratogenicity in rats. *Food Chem. Toxicol.* 21:697.
- Nolen, R. P., A. M. Langer, and G. B. Herson. 1991. Characterization of palygorskite specimens from different geological locales for health hazard evaluation. *Br. J. Ind. Med.* 48:463-475.
- Novakova, J. 1977. Effect of clays on microbe adsorption. *Zentralbl. Bakteriol. Parasitenkd. Intefektionskr. Hyg.* 132:418-422.
- Oberson, D., L. Desfontaines, H. Pezerat, W. Hornebeck, P. Sebastien, and C. Lafuma. 1996. Inhibition of human leukocyte elastase by mineral dust particles. *Am. J. Physiol.* 270:761-771.
- Oscarson, D. W., G. E. Van Scoyoc, and J. L. Ahlrichs. 1981. Effect of Poly-2-vinylpyridine-N-oxide and sucrose on silicate-induced hemolysis of erythrocytes. *J. Pharm. Sci.* 70:657-659.
- Page, R. C., R. R. Heffner, and A. Frey. 1941. Urinary excretion of silica in humans following oral administration of magnesium silicate. *Am. J. Dig. Dis.* 8:13-15.
- Palmieri, A. 1994. Magnesium Aluminum Silicate. In *Handbook of pharmaceutical excipients*, 2nd ed., 269-273. Washington, DC: American Pharmaceutical Association.
- Patterson, E. C., and D. J. Staszak. 1977. Effects of geophagia (kaolin ingestion) on the maternal blood and embryonic development in the pregnant rat. *J. Nut.* 107:2020-2025.
- Pepe, R. C., J. A. Wenninger, and G. N. McEwen Jr., eds. 2002. *International cosmetic ingredient dictionary and handbook*, 9th ed. vols. 1-3. Washington, DC: CTFA.
- Perderiset, M., L. Saint Etrienne, J. Bignon, and M. C. Jaurand. 1989. Interactions of attapulgite (fibrous clay) with human red blood cells. *Toxicol. Lett.* 47:303-310.
- Phibbs, B. P., R. E. Sundin, and R. S. Mitchell. 1971. Silicosis in Wyoming bentonite workers. *Am. Rev. Respir. Dis.* 103:1-17.
- Pigott, G. H., and J. Ishmael. 1992. The effects of intrapleural injections of aluminum and aluminum silicate (ceramic fibers). *Int. Exp. Pathol.* 73:137-146.
- Pond, W. G., and J. T. Yen. 1983a. Protection by clinoptilolite or zeolite NaA against cadmium-induced anemia in growing swine (41652). *Proc. Soc. Exp. Biol. Med.* 173:332-337.
- Pond, W. G., and J. T. Yen. 1983b. Reproduction and progeny growth in rats fed clinoptilolite in the presence or absence of dietary cadmium. *Bull. Environ. Contam. Toxicol.* 31:666-672.
- Pond, W. G., J. T. Yen, and J. D. Crouse. 1989. Tissue mineral element content in swine fed clinoptilolite. *Bull. Environ. Contam. Toxicol.* 42:735-742.
- Porter, T. L., M. P. Eastman, M. E. Hagerman, L. B. Price, and R. F. Shand. 1998. Site-specific prebiotic oligomerization reactions of glycine on the surface of hectorite. *J. Mol. Evol.* 47:373-377.
- Pott, F., F. Huth, and K. H. Friedrichs. 1974. Neoplasmigenic effect of fibrous dusts in experimental animals. *Environ. Health Perspect.* 9:313-315.

- Pott, F., U. Ziem, F. J. Reiffer, F. Huth, H. Ernst, and U. Mohr. 1987. Carcinogenicity studies on fibers, metal compounds, and some other dusts in rats. *Exp. Pathol.* 32:129-152.
- Pylev, L. N., R. G. Bostashvilli, T. F. Kulagina, L. A. Vasilyeva, N. F. Chelishchev, and B. G. Bernstein. 1986. Assessment of carcinogenic activity of zeolite clinoptilolite. *Gig. Tr. prof. Zabol.* 5:29-34.
- Ramos, A. J., J. Fink-Gremmels, and E. Hernandez. 1996. Prevention of toxic effects of mycotoxins by means of nonnutritive adsorbent compounds. *J. Food Prod.* 59:631-641.
- Registry of Toxic Effects of Chemical Substances (RTECS). 1999. *RTECS database*. Bethesda, MD: National Library of Medicine.
- Rempe, J. L., and L. G. Santucci. 1998. *CTFA list of Japanese cosmetic ingredients*, 3rd ed. Washington, DC: CTFA.
- Reiner, A., J. Fleury, G. Monchaux, M. Nebut, J. Bignon, and M. C. Jaurand. 1989. Toxicity of an attapulgite sample studied *in vivo* and *in vitro*. *IARC Sci. Publ.* 90:180-184.
- Reiss, B., J. R. Millette, and G. M. Williams. 1980. The activity of environmental samples in a cell culture test for asbestos toxicity. *Environ. Res.* 22:315-321.
- Renier, A., F. Levy, F. Pilliere, and M. C. Jaurand. 1989. Unscheduled DNA synthesis in rat pleural mesothelial cells treated with mineral fibers. *Mutat. Res.* 24:361-368.
- Rheox Inc. 1999. The benefits of hectorite clay and safety data sheet on Bentone MA (purified hectorite). Unpublished data submitted by Rheox Inc. 3 pages.²
- Richards, R. J., T. D. Tetley, and J. Hunt. 1981. The biological reactivity of calcium silicate composites: In vivo studies. *Environ. Res.* 26:243-257.
- Rogers, R. D., and J. C. MacFarlane. 1981. Sorption of carbon tetrachloride, ethylene dibromide, and trichloroethylene on soil and clay. *Environ. Monit. Assess.* 1:155-162.
- Roskill Information Services Ltd. 1988. *The economics of zeolites*, 1st ed. London: Author.
- Ross, C. S., and P. F. Kerr. 1931. The Kaolin clays. *U.S. Geological Survey Profession Paper* 165E:151-175.
- Sadik, F. 1971. X-ray diffraction analysis for identification of kaolin NF and bentonite USP. *J. Pharm. Sci.* 60:916-918.
- Said, S., and H. Al-Shora. 1980. Adsorption of certain oral hypoglycemics on kaolin and charcoal and its relationship to hypoglycemic effects of drugs. *Int. J. Pharm.* 5:223-228.
- Said, S. A., A. M. Shibal, and M. E. Abdullah. 1980. Influence of various agents on adsorption capacity of kaolin for *Pseudomonas aeruginosa* toxin. *J. Pharm. Sci.* 69:1238-1239.
- Sakai, K., and K. Moriguchi. 1975. Effect of magnesium aluminosilicate administered to pregnant mice on pre- and post-natal development of offspring. *Oyo Yakuri (Pharmacometrics)* 9:704-714.
- Sakula, A. 1961. Pneumoconiosis due to fuller's earth. *Thorax* 16:176-179.
- Schiffenbauer, M., and G. Stotzky. 1982. Adsorption of coliphages T1 and T7 to clay minerals. *Appl. Environ. Microbiol.* 43:90-96.
- Schreider, J. P., M. R. Culbertson, and O. G. Raabe. 1985. Comparative pulmonary potential of selected particles. *Environ. Res.* 38:256-274.
- Sherwin, R. P. 1979. Silicate pneumoconiosis of farm workers. *Lab. Invest.* 40:576-582.
- Shibayama, Y., M. Nishioto, and K. Nakata. 1993. Role of microenvironmental deterioration of the bone marrow in the development of bone atrophy in magnesium silicate-treated rats. *Exp. Toxicol. Pathol.* 45:71-74.
- Shurson, G. C., P. K. Ku, E. R. Miller, and M. T. Yokoyama. 1984. Effect of zeolite A or clinoptilolite in diets of growing swine. *J. Anim. Sci.* 59:1536-1545.
- Skaug, V., R. Davies, and B. Glyseth. 1984. In vitro macrophage cytotoxicity of five calcium silicates. *Br. J. Ind. Med.* 41:116-121.
- Skaug, V., and B. Gyseth. 1983. Hemolytic activity of five different calcium silicates. *Environ. Health Perspect.* 51:195-203.
- Smith, T. K. 1980. Influence of dietary fiber, protein, and zeolite on zearalenone toxicosis in rats and swine. *J. Anim. Sci.* 50:278-285.
- Snipes, M. B., B. B. Boecker, and R. O. McClellan. 1983a. Retention of monodisperse or polydisperse aluminosilicate particles inhaled by dogs, rats, and mice. *Toxicol. Appl. Pharmacol.* 69:345-362.
- Snipes, M. B., B. A. Muggenburg, and D. E. Bice. 1983b. Translocation of particles from lung lobes or the peritoneal cavity to regional lymph nodes in beagle dogs. *J. Toxicol. Environ. Health* 11:703-712.
- Stanton, M. F., M. Layard, A. Tegeris, E. Miller, M. May, E. Morgan, and A. Smith. 1981. Relation of particle dimension to carcinogenicity in amphibole asbestos and other fibrous minerals. *J. Natl. Cancer Inst.* 67:965-975.
- Steel, R. F., and W. Anderson. 1972. The interaction between kaolinite and *Staphylococcus aureus*. *J. Pharm. Pharmacol.* 24:129.
- Stookey, G. K., J. L. McGuire, S. M. Standish, and J. C. Muhler. 1967. Studies concerning the biological properties of zirconium silicate. *J. Peridontol.* 38:53-63.
- Stotzky, G. 1966. Influence of clay minerals on microorganisms: II. Effect on various clay species, homoionic species, and other particles on bacteria. *Can. J. Microbiol.* 12:831-848.
- Stotzky, G., and L. T. Rem. 1966. Influence of clay minerals on microorganisms: I. Montmorillonite and kaolinite on bacteria. *Can. J. Microbiol.* 12:547-562.
- Stotzky, G., and L. T. Rem. 1967. Influence on clay minerals on microorganisms: IV. Montmorillonite and kaolinites on fungi. *Can. J. Microbiol.* 13:1535-1550.
- Strigunkova, T. F., G. A. Lavrentiev, and V. A. Ostroshchenko. 1986. Abiogenic synthesis of oligonucleotides on kaolinite under the action of ultraviolet radiation. *J. Mol. Evol.* 23:290-293.
- Suzuki, Y. 1982. Carcinogenic and fibrogenic effects of zeolites: preliminary observations. *Environ. Res.* 27:433-445.
- Suzuki, Y., and N. Kohyama. 1984. Malignant mesothelioma induced by asbestos and zeolite in the mouse peritoneal cavity. *Environ. Res.* 35:277-292.
- Sykes, S. E., A. Morgan, J. C. Evans, A. Holmes, and S. R. Moores. 1982. Use of an in vivo test system to investigate the acute and sub-acute responses of the rat lung to mineral dusts. *Ann. Occup. Hyg.* 26:593-605.
- Syracuse Research Corporation. 1981. Information profiles on potential occupational hazards: Aluminum and compounds. Second draft (revised). NTIS report no. PB89216238.
- Tatrai, E., Z. Adamis, M. Tim'ar, and G. Ung'ary. 1983. Comparative histopathological and biochemical analysis of early stages of exposure to non-silicogenic aluminum silicate and strongly silicogenic quartz-dust in rats. *Exp. Pathol.* 23:163-171.
- Tatrai, E., E. Ba'csy, J. Ka'rp'a'ti, and G. Ungv'ary. 1992. On the examination of the pulmonary toxicity of mordenite in rats. *Polish J. Occup. Med. Environ. Health* 5:237-243.
- Tatrai, E., and G. Ungv'ary. 1983. Study on carcinogenicity of clinoptilolite type zeolite in Wistar rats. *Polish J. Occup. Med. Environ. Health* 6:27-34.
- Tatrai, E., and G. Ungv'ary. 1993. Study on carcinogenicity of clinoptilolite type zeolite in wistar rats. *Polish J. Occup. Med. Environ. Health* 6:27-34.
- Tatrai, E., G. Ungv'ary, Z. Adamis, and M. Tim'ar. 1985. Short term in vivo method for prediction of the fibrogenic effect of different mineral dusts. *Exp. Pathol.* 28:111-118.
- Tatrai, E., I. Wojn'arovits, and G. Ungv'ary. 1991. Non-fibrous zeolite induced experimental pneumoconiosis in rats. *Exp. Pathol.* 43:41-61.
- Toilet Goods Association. 1969. Concentration and product use data. Unpublished data submitted by R. T. Vanderbilt Co., Inc. 2 pages.²
- Tonning, H. O. 1949. Pneumoconiosis from fuller's earth. *J. Ind. Hyg. Toxicol.* 31:41-45.
- United States Pharmacopeial Convention, Inc. 1994. *The United States Pharmacopeia*, vol. 23, and the *National Formulary*, vol. 18. Tauton, MA: Rand McNally.
- Valatina, I. E., L. N. Pylev, and M. F. Lemjasev. 1994. Mutagenicity of the zeolite dusts. *Gig. Sanit.* 4:65-67.
- van Hoof, J. H. C., and J. W. Roelofsen. 1991. Techniques of zeolite characterization. In *Introduction to zeolite science and practice*, H. van Bekkum, E. M. Flanigen, and J. C. Jansen, 241-283. Amsterdam: Elsevier.
- Wagner, J. C., D. M. Griffiths, and D. E. Munday. 1987. Experimental studies with palygorskite dusts. *Br. J. Ind. Med.* 44:749-763.
- Wagner, J. C., F. D. Pooley, A. Gibbs, L. Lyons, G. Sheers, and C. B. Moncrieff. 1996. Inhalation of china stone and clay dusts: Relationship between the

- mineralogy of dust retained in the lungs and pathological changes. *Thorax* 41:190-196.
- Wagner, J. C., J. W. Skidmore, R. J. Hill, and D. M. Griffiths. 1985. Eronite exposure and mesotheliomas in rats. *Br. J. Cancer* 51:727-730.
- Wallace, W. E., V. Vallyathan, M. J. Keane, and V. Robinson. 1985. In vitro biological toxicity of native and surface-modified silica and kaolin. *J. Toxicol. Environ. Health* 16:415-424.
- Waxweiler, R. J., R. D. Zumwalde, G. O. Ness, and D. P. Brown. 1988. A retrospective cohort mortality study of males mining and milling attapulgite clay. *Am. J. Ind. Med.* 13:305-315.
- Wells, I. P., R. C. V. Bhatt, and M. Flanagan. 1985. Kaolinitis a radiological review. *Clin. Radiol.* 36:579-582.
- Wenninger, J. A., R. C. Canterbury, and G. N. McEwen, Jr., eds. 2000. *International Cosmetic Ingredient Dictionary and Handbook*, 8th edn., vols. 1-3. Washington, DC: CTFA.
- Williams, K. C., B. J. Blaney, and R. T. Peters. 1994. Pigs fed *Fusarium*-infected maize containing zearalenone and nivalenol with sweeteners and bentonite. *Livest. Prod. Sci.* 39:275-281.
- Woodworth, C. D., B. T. Mossman, and J. E. Craighead. 1982. Comparative effects of fibrous and nonfibrous minerals on cells and liposomes. *Environ. Res.* 27:190-205.
- Woodworth, C. D., B. T. Mossman, and J. E. Craighead. 1983. Induction of squamous metaplasia in organ cultures of hamster trachea by natural and synthetic fibers. *Cancer Res.* 43:4906-4912.
- Wright, W. E., and F. Moatamed. 1983. Characterization of zeolite fiber sizes using scanning electron microscopy. *Arch. Environ. Health* 38:99-103.
- Yegles, M., X. Janson, H. Y. Dong, R. Renier, and M. C. Jaurand. 1995. Role of fiber characteristics and induction of anaphase/telophase aberrations in rat pleural mesothelial cells in vitro: Correlations with in vivo animal findings. *Carcinogenesis* 16:2751-2758.
- Zaidi, S. H., K. S. Dogra, S. Khanna, and R. Shanker. 1981. Experimental ineffective pneumoconiosis: Effect of fibrous and nonfibrous silicates and *Candida albicans* on the lungs of guinea pigs. *Ind. Health* 19:85-92.
- Zhang, W. C., Q. F. Zhang, and Z. F. Song. 1997. Studies on the hazardous effects and the maximum allowable concentration of pyrophyllite dust. *Biomed. Environ. Sci.* 10:377-386.
- Zumwalde, R. 1976. Industrial Hygiene Study. Englehard Minerals and Chemicals Corporation. Attapulgus, GA (NIOSH 00106935), Cincinnati, OH: National Institute for Occupational Safety and Health. August 2, 1999.

Final Report on the Safety Assessment of Potassium Silicate, Sodium Metasilicate, and Sodium Silicate¹

Potassium Silicate, Sodium Metasilicate, and Sodium Silicate combine metal cations with silica to form inorganic salts used as corrosion inhibitors in cosmetics. Sodium Metasilicate also functions as a chelating agent and Sodium Silicate as a buffering and pH adjuster. Sodium Metasilicate is currently used in 168 formulations at concentrations ranging from 13% to 18%. Sodium Silicate is currently used in 24 formulations at concentrations ranging from 0.3% to 55%. Potassium Silicate and Sodium Silicate have been reported as being used in industrial cleaners and detergents. Sodium Metasilicate is a GRAS (generally regarded as safe) food ingredient. Aqueous solutions of Sodium Silicate species are a part of a chemical continuum of silicates based on an equilibrium of alkali, water, and silica. pH determines the solubility of silica and, together with concentration, determines the degree of polymerization. Sodium Silicate administered orally is readily absorbed from the alimentary canal and excreted in the urine. The toxicity of these silicates has been related to the molar ratio of $\text{SiO}_2/\text{Na}_2\text{O}$ and the concentration being used. The Sodium Metasilicate acute oral LD_{50} ranged from 847 mg/kg in male rats to 1349.3 mg/kg in female rats and from 770 mg/kg in female mice to 820 mg/kg in male mice. Gross lesions of variable severity were found in the oral cavity, pharynx, esophagus, stomach, larynx, lungs, and kidneys of dogs receiving 0.25 g/kg or more of a commercial detergent containing Sodium Metasilicate; similar lesions were also seen in pigs administered the same detergent and dose. Male rats orally administered 464 mg/kg of a 20% solution containing either 2.0 or 2.4 to 1.0 ratio of sodium oxide showed no signs of toxicity, whereas doses of 1000 and 2150 mg/kg produced gasping, dyspnea, and acute depression. Dogs fed 2.4 g/kg/day of Sodium Silicate for 4 weeks had gross renal lesions but no impairment of renal function. Dermal irritation of Potassium Silicate, Sodium Metasilicate, and Sodium Silicate ranged from negligible to severe, depending on the species tested and the molar ratio and concentration tested. Sodium Metasilicate was negative in the local lymph node assay (LLNA), but a delayed-type hypersensitivity response was observed in mice. Potassium Silicate was nonirritating in two acute eye irritation studies in rabbits. Sodium Metasilicate (42.4% H_2O) was corrosive to the rabbit eye. Sodium Silicate was a severe eye irritant in some eye irritation studies, but was irritating or nonirritating in others. A skin freshener containing Sodium Silicate was nonirritating. Sodium Metasilicate was nonmutagenic in bacterial cells. Rats given Sodium Silicate (600 and 1200 ppm of added silica) in the drinking water in reproductive studies produced a reduced number of offspring: to 67% of controls at 600 ppm and to 80%

of controls at 1200 ppm. Three adult rats injected intratesticularly and subcutaneously with 0.8 mM/kg of Sodium Silicate showed no morphological changes in the testes and no effect on the residual spermatozoa in the ductus deferens. Sodium Metasilicate (37% in a detergent) mixed with water was a severe skin irritant when tested on intact and abraded human skin, but 6%, 7%, and 13% Sodium Silicate were negligible skin irritants to intact and abraded human skin. Sodium Silicate (10% of a 40% aqueous solution) was negative in a repeat-insult predictive patch test in humans. The same aqueous solution of Sodium Silicate was considered a mild irritant under normal use conditions in a study of cumulative irritant properties. The Cosmetic Ingredient Review (CIR) Expert Panel recognized the irritation potential of these ingredients, especially in leave-on products. However, because these ingredients have limited dermal absorption and Sodium Metasilicate is a GRAS direct food substance, the Panel deemed the ingredients safe for use in cosmetic products in the practices of use and concentration described in this safety assessment, when formulated to avoid irritation.

INTRODUCTION

This report reviews the safety of silicate salts as used in cosmetic formulations. Because they are considered to have similar safety profiles, the following silicate salts are reviewed in this assessment: Potassium Silicate (CAS no. 1312-76-1), Sodium Metasilicate (CAS no. 6834-92-0), and Sodium Silicate (CAS no. 1344-09-8).

CHEMISTRY

These ingredients combine metal cations (potassium or sodium) with silica to form inorganic salts. A tabular presentation of chemical descriptions is provided in Table 1.

Physical and Chemical Properties

The properties, synonyms, and specifications are listed in tabular form in Table 2.

According to O'Conner (1961), pH determines the solubility of silica and, together with concentration, determines its degree of polymerization. At about pH 7, silica is only slightly soluble in water. At around pH 12, in a Sodium Metasilicate solution (0.1%), silica is very soluble and exists in monomeric form. At an intermediate pH, Sodium Metasilicate is partially neutralized; that is, it changes ratio and becomes a Sodium Silicate of $1\text{Na}_2\text{O}:\text{XSiO}_2$, where X is greater than unity. Conversely, a Sodium Silicate of the ratio $1\text{Na}_2\text{O}:\text{XSiO}_2$ could be converted to Metasilicate by the addition of alkali.

¹Reviewed by the Cosmetic Ingredient Review Expert Panel. This report was prepared by Amy R. Elmore, former CIR Scientific Analyst and Writer. Address correspondence to F. Alan Andersen, Director, CIR, 1101 17th Street, NW, Suite 310, Washington, DC 20036, USA.

TABLE 1
Ingredient descriptions

Ingredient	Description	Reference
Potassium Silicate	SiO ₂ :K ₂ O ratio varies	Budavari (1989)
	Potassium salt of silicic acid	Gottschalck and McEwen (2004)
Sodium Metasilicate	Na ₂ SiO ₃	Gottschalck and McEwen (2004)
	Inorganic salt	Gottschalck and McEwen (2004)
Sodium Silicate	Na ₂ O·xSiO ₂	Lide (1993)
	Sodium salt of silicic acid	Gottschalck and McEwen (2004)

Method of Manufacture

Soluble silicates (Sodium Silicate and Sodium Metasilicate) are manufactured by the reaction of silica sand and sodium carbonate (soda ash) at ~1400°C. Typically, a no. 1 grade of glass sand containing no more than 300 ppm iron and a medium density soda ash are used. Potassium Silicates are manufactured in a similar manner by the reaction of K₂CO₃ and sand (Kirk-Othmer 1982).

Sodium Silicates are either made by the high temperature fusion of silica sand (SiO₂) and soda (Na₂CO₃) at about 1300°C or by a hydrothermal process using silica sand and sodium hy-

droxide as starting materials. Solutions, termed "waterglass," are prepared by the solubilization of lumps of silicate salts in water at elevated temperatures and pressure. The water content of "waterglass" is between 45% and 80%. Powders are prepared by spray- or drum-drying of "waterglass" solutions. The residual water content can be between 0% and 25% (EUCLID 2000).

Impurities

Kirk-Othmer (1982) provided a range of trace elements in a typical Sodium Silicate solution as shown in Table 3. Impurity limits for Arsenic and Lead are shown in Table 2.

TABLE 2
Properties, synonyms, and specifications

<i>Potassium Silicate</i>		
Synonyms	Silicic acid, potassium salt	Gottschalck and McEwen (2004)
Form/description	Yellowish to colorless, translucent to transparent, hygroscopic	Budavari (1989)
Solubility	Insoluble in alcohol, slightly soluble in water	Budavari (1989)
<i>Sodium Metasilicate</i>		
Synonyms	Silicic acid, disodium salt Crystamet, disodium metasilicate, disodium monosilicate, Metso, water glass, sodium metasilicate anhydrous	Gottschalck and McEwen (2004) RTECS (1999)
Form/description	Nonahydrate, efflorescent platelets	Budavari (1989)
Molecular weight	122.08	Budavari (1989)
pH	12 (0.1% solution)	O'Conner (1961)
Density	2.614	Budavari (1989)
Solubility	Insoluble in alcohol, acids, and salt solns.	Budavari (1989)
Melting point	1089°C	CTFA (2000a)
Forms	Anhydrous, pentahydrate, and nonahydrate	21 CFR 184.1769a
Impurity limits	Arsenic (as As) 3 ppm maximum Lead (as Pb) 20 ppm maximum	Nikitakis and McEwen (1990) Nikitakis and McEwen (1990)
<i>Sodium Silicate</i>		
Synonyms	Silicic acid, sodium salt Sodium waterglass, waterglass, soluble glass, sodium silicate glass	Gottschalck and McEwen (2004) EUCLID (2000)
Form/description	Colorless to white or grayish-white, crystal-like clumps or aqueous solutions	Budavari (1989)
pH	Strongly alkaline	Budavari (1989)
Impurity limits	Arsenic (as As) 3 ppm maximum Lead (as Pb) 20 ppm maximum (40% solution)	Nikitakis and McEwen (1990) Nikitakis and McEwen (1990)

TABLE 3
Trace elements in Sodium Silicate (Kirk-Othmer 1982)

Impurity	Measured Values		Impurity	Measured Values	
	Low	High		Low	High
F	6.7 ppm	9.5 ppm	V	Below 0.3 ppm detection limit	0.8 ppm
Cl	130 ppm	1900 ppm	Cr	Below 0.3 ppm detection limit	1.0 ppm
SO ₄	Below 160 ppm detection limit	1700 ppm	Ni	Below 0.3 ppm detection limit	0.3 ppm
N	0.1 ppm	44 ppm	Co	Below 0.3 ppm detection limit	<0.3 ppm
As	Below 1 ppm detection limit	<1 ppm	Zn	Below 0.6 ppm detection limit	2.8 ppm
Hg	Below 0.26 ppb detection limit	2.5 ppb	Cu	Below 0.6 ppm detection limit	1.1 ppm
Pb	0.17 ppm	0.60 ppm	Bi	Below 25 ppm detection limit	<25 ppm
Cd	Below 10 ppb detection limit	21 ppb	Sr	Below 0.2 ppm detection limit	1.5 ppm
Fe	36 ppm	120 ppm	Ba	Below 0.2 ppm detection limit	2.8 ppm
Mg	4 ppm	26 ppm	Mn	0.1 ppm	1.8 ppm
Ca	Below 1 ppm detection limit	76 ppm	Sn	Below 60 ppm detection limit	<60 ppm
Al	50 ppm	220 ppm	Sb	Below 15 ppm detection limit	< 15 ppm
P	Below 18 ppm detection limit	<18 ppm	Se	Below 20 ppm detection limit	<20 ppm

USE

Cosmetic

Potassium Silicate functions as a corrosion inhibitor in cosmetics (Gottschalck and McEwen 2004). Voluntary reports by industry to the Food and Drug Administration (FDA) on product use included use of Potassium Silicate in two formulations as shown in Table 4 (FDA 2001). Industry did not report any concentration of use information for Potassium Silicate.

Sodium Metasilicate functions as a chelating agent and corrosion inhibitor in cosmetic formulations (Gottschalck and McEwen 2004). Of the 191 formulations reported to the FDA, over 80% were used in hair dyes and colors (FDA 2001). Table 4 shows the types of cosmetic formulations in which Sodium Metasilicate is reported to be used and gives current concentrations of use as provided by industry.

In those cases where a current concentration of use is provided, but there are no reports to FDA of use, it should be assumed that the ingredient may be in current use.

Sodium Silicate functions as a buffering agent, corrosion inhibitor, and a pH adjuster (Gottschalck and McEwen 2004). Sodium Silicate was reported to be used in 22 formulations (FDA 2001). Table 4 shows the types of cosmetic formulations in which Sodium Silicate is reported to be used and gives current concentrations of use as provided by industry.

There are no restrictions for the use of these silicate salts in cosmetics in Japan according to the Ministry of Health, Labor, and Welfare (2000) nor in Europe according to the European Economic Community (1999).

Noncosmetic

The principle uses of soluble silicates are in the manufacturing of soaps and detergents. They provide a constant pH value in

the detergent system and aid in the saponification of oils and fats by means of their alkaline nature and buffering ability. Soluble Silicates are also used in water treatment, as an adhesive and fireproof coating additive, as a paper de-inking agent, as an egg preservative, and as a inhibitor of metal corrosion (Kirk-Othmer 1982).

FDA affirmed Sodium Metasilicate as a GRAS (generally regarded as safe) direct food substance (Code of Federal Regulations, 21CFR184.1769a) with no limitation other than current good manufacturing practice. Sodium Metasilicate's uses in foods include processing aid; washing and lye peeling of fruits, vegetables, and nuts; denuding agent in tripe; hog scald agent in removing hair; and a corrosion preventative in canned and bottled water. The Select Committee of the Federation of American Societies for Experimental Biology (FASEB) (1981) concluded: "There is no evidence in the available information on Sodium Metasilicate that demonstrates or suggests reasonable grounds to suspect a hazard to the public when it is used as a food ingredient in a manner now practiced at levels that are now current or might reasonably be expected in the future."

Rhone-Poulenc (1971a) reported Sodium Silicate being used in industrial cleaners and detergents.

Potassium Silicate was reported by Reynolds et al. (1998) as an alternative to sulfur for controlling powdery mildew. Rhone-Poulenc (1971b) reported Potassium Silicate being used in industrial cleaners and detergents.

GENERAL BIOLOGY

Absorption, Distribution, Metabolism, and Excretion

Two groups of four male Sprague-Dawley Cox rats were fasted for 17 to 18 h and then administered Sodium Silicate orally in doses of 40 or 1000 mg/kg body weight (bw). Four control

TABLE 4
Product formulation data

Product category (number of formulations in each category) (FDA 2001)	Formulations containing ingredient (FDA 2001)	Reported range of use concentrations (CTFA 1999, 2000b)
<i>Potassium Silicate</i>		
Noncoloring hair preparations		
Other hair preparations (276)	1	—
Skin care preparations		
Paste masks (mud packs) (269)	1	—
Totals/ranges for Potassium Silicate	2	
<i>Sodium Metasilicate</i>		
Noncoloring hair preparations		
Hair straighteners (63)	1	—
Hair coloring preparations		
Hair dyes and colors (1588)	158	—
Hair lighteners with color (5)	2	14%
Hair bleaches (115)	24	13%–18% (diluted to 7%–14% before use)
Other hair coloring preparations (59)	4	—
Shaving preparations		
Shaving cream (133)	2	—
Totals/ranges for Sodium Metasilicate	191	
<i>Sodium Silicate</i>		
Baby products		
Other baby products (29)	—	0.6%
Eye makeup preparations		
Other eye makeup preparations (151)	1	—
Hair-coloring preparations		
Hair bleaches (115)	7	16%–55% (diluted to 1%–20% before use)
Hair dyes and colors (1572)	—	1%
Other hair coloring preparations (59)	1	35%
Bath preparations		
Bath soap and detergents (405)	2	0.06%–7%
Oral hygiene products		
Dentifrices (aerosol, liquid, pastes, and powders) (38)	—	0.6%
Shaving preparations		
Shaving cream (133)	6	0.3%–5%
Shaving soap (<4)	—	0.4%
Skin care preparations		
Skin cleansing creams, lotions, liquid, and pads (653)	—	10%
Depilatories (28)	4	2%
Face and neck skin care preparations (304)	1	—
Other skin preparations (692)	—	1%
2001 Totals/ranges for Sodium Silicate	22	0.06%–35%

animals received 10 ml of quartz-distilled water. All suspensions contained <0.5 ppm of silicon and aluminum. Urine samples were collected over an 8-h period and afterwards the remaining urine in the bladder was collected. The concentrations of silicon were measured by induction-coupled RF plasma optical emission spectrometry. Silicon excretion was most rapid during the first 24 h after dosing. After subtracting the control values, the

urinary silicon excretion at 40 and 1000 mg Sodium Silicate/kg was 18.9% and 2.8%, respectively (Benke and Osborn 1979).

In Vitro Assays

Sodium Metasilicate

Neutralized Sodium Metasilicate, at concentrations of up to 0.025 M, inhibited urease and invertase in vitro, but had

little effect on many other enzymes such as pepsin, trypsin, lipase, catalase, or cholinesterase (Kind et al. 1954; Alexander 1968).

Skin² ZK 1350 cultures were used to evaluate skin corrosion and develop a classification of 50 chemicals in a study by Liebsch et al. (1995). Skin² cultures are a three-dimensional human skin model with a stratum corneum grown from neonatal human skin cells. The epidermal side of the cultures was placed onto 15 μ l of Sodium Metasilicate on glass coverslips for 10 s. Phosphate-buffered saline was used to wash the test material residue. Cell viability was assessed using the tetrazolium derivative reduction cytotoxicity assay. The controls were treated with distilled water. In this assay, a corrosive chemical will have a <80% viability rate. A noncorrosive classification corresponds to a >80% viability rate. Sodium Metasilicate had a mean viability (\pm SD) of 65.8 ± 10.4 . The authors classified Sodium Metasilicate as corrosive.

Sodium Silicate

Sodium Silicate was also tested by Liebsch et al. (1995) in the same study as the previous experiment. Two different chemical names were tested, Sodium Silicate A140 and Sodium Silicate H100. Sodium Silicate A140 is classified as group II and Sodium Silicate H100 is classified as non-corrosive according to in vivo UN packing guidelines. The ZK 1350 percent viability mean \pm SD for Sodium Silicate A140 and Sodium Silicate H100 were 82.3 ± 12.0 and 91.5 ± 10.9 , respectively. The corrosivity classification for Sodium Silicate A140 was determined to be non-corrosive, but was noted to be a false negative. Sodium Silicate H100 was classified as non-corrosive. Both chemicals were predicted by the ZK 1350 assay to be non-corrosive according to United Nations (UN) packing guidelines.

ANIMAL TOXICOLOGY

Acute Oral

Sodium Metasilicate

Rhone-Poulenc (1971b) conducted a study in which male Sprague-Dawley rats were administered a 20% solution of Sodium Metasilicate by gastric intubation. Five animals per dose of 464, 1000, 2150, and 4640 mg/kg were used. The animals were observed for 14 days for mortality and signs of toxicity.

All rats given the largest dose died and necropsy was performed on these animals. No apparent signs of toxicity were produced at 464 mg/kg. Animals treated with either ratio at doses of 1000 and 2150 mg/kg had gasping, dyspnea, and acute depression. Signs in groups given 4640 mg/kg included acute depression, nasal discharge, dyspnea, and gasping. All dead rats had gross gastrointestinal hemorrhages with congestion of the kidneys, adrenal glands, liver, lungs, and heart. The acute oral LD₅₀ was 847 mg/kg (Rhone-Poulenc 1971b).

Muggenberg et al. (1974) gave groups of three beagle dogs single doses of 0.1, 0.25, 0.5, 1.0, and 2.5 g/kg of a commercially

available detergent containing Sodium Metasilicate. No details about the percentage of Sodium Metasilicate in the detergent were given.

All dogs that received the highest dose died within 54 h. Gross lesions of variable severity were found in the oral cavity, pharynx, esophagus, stomach, larynx, lungs, and kidneys of all dogs receiving 0.25 g/kg or more. No lesions were found in dogs that received 0.1 g/kg. Microscopic lesions included acute necrosis of the epithelial lining of the digestive tract, necrosis, ulceration and edema of the larynx, edematous lungs, and necrosis of the proximal renal tubules.

In a second experiment, three pigs were given a single dose of 0.25 g/kg of the same detergent used in the dog study. One pig died 95 h after ingestion. Lesions in the pigs were similar to those found in the dogs (Muggenberg et al. 1974).

The Federation of American Societies for Experimental Biology (1981) listed the following LD₅₀ values for Sodium Metasilicate: rat (oral) 1.28 g/kg; rat (oral) 3 g/kg; and mouse (oral) 3 g/kg, and stated that "accidental exposure to strongly alkaline, concentrated solutions of Sodium Metasilicate such as those used in certain common detergent preparations, can produce caustic, irritating effects on contact with the eye, skin, and mucous membranes of the alimentary tract and respiratory system."

Ito et al. (1986) reported the LD₅₀ of Sodium Metasilicate as 1152.8 mg/kg in male rats, 1349.3 mg/kg in female rats, 820 mg/kg in male mice, and 770 mg/kg in female mice. Changes in the animals that survived after peroral administration of large doses in acute studies were mainly bleeding in the stomach and duodenum, and erosion of the small intestine.

Sodium Silicate

A summary of information on Sodium Silicate provided by European companies (EUCLID 2000) included acute oral toxicity data shown in Table 5.

In a study by Rhone-Poulenc (1971b), male Sprague Dawley rats were administered a 20% solution of a 2.0 and 2.4 ratio of Sodium Silicate to 1.0 ratio of sodium oxide by gastric intubation. The 2.0 and 2.4 ratios were corrected for moisture content and tested on an equivalent anhydrous basis. Five animals per dose group at 464, 1000, 2150, and 4640 mg/kg were used. The animals were observed for 14 days for mortality and other signs of toxicity. Necropsy was performed on animals of the largest doses.

In the highest dose group, 4/5 rats of the 2.0 ratio material and 5/5 rats of the 2.4 ratio material died. No apparent signs of toxicity were produced at 464 mg/kg. Animals treated with either ratio at doses of 1000 and 2150 mg/kg had gasping, dyspnea, and acute depression. The highest dose group animals had acute depression, nasal discharge, dyspnea, and gasping. Dead animals had gastrointestinal hemorrhages and congestion of the kidneys, adrenal glands, liver, lungs, and heart. The acute oral LD₅₀ was reported to be 1960 mg/kg in groups receiving the 2.0 ratio material of Sodium Silicate and 2710 mg/kg

TABLE 5
Sodium Silicate oral LD₅₀ values in the rat (EUCLID 2000)

LD ₅₀	Molar ratio/concentration	Remarks
2000–2500 mg/kg	Molar ratio of 1.6 and a concentration of 51%	The acute oral toxicity of alkaline sodium silicates is dependent on the SiO ₂ /Na ₂ O molar ratio, and to a lesser extent on the concentration of dissolved dry matter (due to pH dependence); autopsy results showing acute gastroenteritis, vascular congestion, and mottled livers are consistent with nonspecific causes of death.
1600–8600 mg/kg	Molar ratio of 3.0 and various concentrations	
1500–2200 mg/kg	Molar ratio of 2.0 and concentration of 81%	
1300–2100 mg/kg	Molar ratio of 2.0 and various concentrations	
1600 mg/kg	Molar ratio of 2.0 and concentration of 81%	
7150–10500 mg/kg	Molar ratio of 3.4	Ten male rats of different species were used and the observed range in LD ₅₀ values was due to intraspecies susceptibility.
>2000 mg/kg	Molar ratio of 3.45 and concentration of 35%	All symptoms of intoxication were reversible and no signs of histopathologic abnormalities were observed 14 days after application of the substance.

in groups receiving the 2.4 ratio material (Rhone-Poulenc 1971b).

Short-Term Oral

Sodium Metasilicate

Albino mice (210) and rabbits (20) dosed daily with 200 to 300 mg/kg Sodium Metasilicate for 1 month showed “a cellular proliferation in the internal organs.” No details of number of animals by dose, sex, age, strain, or mortality were reported (Shakhbazyan and Karapetyan 1963).

Schwarz and Milne (1972) found that Sodium Metasilicate (Na₂SiO₃·9H₂O) added to silicon-depleted, chemically defined diets of weanling Fisher 344 rats resulted in 25% to 34% increases in growth rates compared with control animals on silicon-depleted diets. The estimated dose of silicon was about 100 mg/kg/day. Growth retardation and a disturbance in bone formation were reported to be signs of silicon deficiency, presumably as a result of faulty bone matrix formation and inadequate cross-linkage of acid mucopolysaccharides and other connective tissue components.

Sodium Silicate

In a study by Kayongo-Male and Jia (1999), 36 male Sprague-Dawley albino rats were randomly allotted into a two-dietary-treatment experiment. The dietary treatments included a control basal diet consisting of dextrose–egg albumin in that contained <5.0 ppm Si and a diet supplemented with 500 ppm Si obtained by the addition of Sodium Silicate.

The addition of dietary Si affected rat body-weight changes. Rats on the supplemented diet had slower growth rates than control rats. At the end of 8 weeks, rats on the treated diet weighed

257 g on average compared to 273 g for control rats. Hemoglobin levels were lower ($p < .05$) in treated rats. Plasma Ca content was also lower in treated rats ($p < .05$). Plasma Mg levels were higher ($p < .05$) in control rats. Plasma Cu and P were not affected. The source of Si did not affect ($p < .05$) organ weights or their mineral concentrations except liver Zn concentrations, which were higher in the control group (Kayongo-Male and Jia 1999).

Subchronic Oral

Sodium Metasilicate

In a subchronic study with Sodium Metasilicate in the drinking water of Wistar rats, no specific changes in the high-dose animals were observed. Slight degenerative changes in the epithelium of renal tubules were observed in higher doses. Maximum safety concentrations were 1500 ppm/L/day (792 mg/kg/day) (Ito et al. 1986).

Sodium Silicate

Newberne and Wilson (1970) fed eight female and eight male beagle dog 2.4 g/kg/day of Sodium Silicate in their diets for 4 weeks to study renal damage. Six animals of each sex were used as controls, receiving the same diet without Sodium Silicate. In addition, 15 rats (Charles River CD strain) of each sex were fed the same diet with Sodium Silicate and 15 rats of each sex received the control diet. Animals were killed at the end of 4 weeks and necropsied. Tissues were preserved in formaldehyde for histopathologic examination.

Body weight, feed intake, and urinary specific gravity and blood (protein and glucose) measurements were the same for both test and control dogs and rats. Polydipsia and polyuria were

observed in both the dogs and rats. Gross renal cortical lesions were seen in 8/8 male and 7/8 female dogs. The authors stated that the appearance of the cut surface suggested cortical infarcts. Despite extensive renal damage, impairment of renal function was not detected. No treatment-related lesions were found in the rats (Newberne and Wilson 1970).

Smith et al. (1973) added a Sodium Silicate solution to the drinking water containing 600 and 1200 ppm of added silica and given to groups of six weanling male and six female Sprague-Dawley rats. Growth, nitrogen and phosphorous retention, and reproductive effects were investigated (discussed later in this report). Control groups received no Sodium Silicate in their drinking water. At 4 months of age, the rats of treatment groups were mated. The treated water, 600 ppm, combined with a normal, commercial diet for rats increased body weight gains of the male rats by ~6% over controls but decreased gains of the female rats by ~5% compared to controls. Retention of nitrogen and phosphorous were significantly affected. No apparent effect of the treatment in the drinking water was found on the longevity in rats having started treatment after weaning.

Acute Parenteral

Intraperitoneal injections of a neutralized 2% solution of Sodium Metasilicate (~1200 mg/kg on day 1 and 800 mg/kg on days 2 and 3) into white rats resulted in a 60% decrease in spleen weight and relative enlargement of the kidneys when the animals were examined on the third day. There were microscopic lesions of the lymphatic tissues and cellular damage in parts of the intestinal mucosa (Nanetti 1973).

Dermal Irritation

Potassium Silicate

Potassium Silicate was tested for primary skin irritation according to the Draize Dermal procedure after a 24-h exposure in six rabbits (three male and three female). No dose was indicated. The primary irritation index was 1.83 and the compound was classified as a mild irritant (Rhone-Poulenc 1971a).

A summary of information on Potassium Silicate put together by European companies (EUCLID 2000) included the skin irritation data shown in Table 6.

Sodium Metasilicate

Sodium Metasilicate (42.4% H₂O) was tested for skin irritation according to the Draize Dermal procedure in six rabbits (three male and three female). The results were scored at 8.0 and was classified as a corrosive. The authors stated that the result was expected because the pH of the solution was 12.4 (Rhone-Poulenc 1971b).

A commercial product containing 5% Sodium Metasilicate was tested in acute dermal toxicity studies using male and female white New Zealand rabbits. The dermal LD₅₀ was >200 mg/kg. Necrosis and edema were observed at the treatment site (Rhone-Poulenc 1976).

A Sodium Metasilicate/carbonate granular detergent was applied to intact and abraded skin of rabbits and guinea pigs for 4 h. Skin responses were graded at 4, 24, and 48 h after the patch applications. The detergent contained 37% Sodium Metasilicate. Rabbit skin and guinea pig skin reacted differently as shown in Table 7 (Nixon, Tyson, and Wertz 1975).

Sodium Silicate

Sodium Silicate was tested for primary skin irritation according to the Draize Dermal procedure after 4 and 24 h exposures in rabbits. Both primary irritation indexes for 4 and 24 h were 8.0 and the compound was classified as corrosive (Rhone-Poulenc 1971a).

A 2.0 ratio and 2.4 ratio of Sodium Silicate to 1.0 sodium oxide with 19.5% water was tested for skin irritation according to the Draize Dermal procedure in rabbits. The 2.0 ratio material was scored a 5.9 and was classified as a severe irritant; the 2.4 ratio material was scored a 4.12 and was classified as a moderate irritant. An acute dermal toxicity study utilizing New Zealand white rabbits was also conducted. Both ratio materials of Sodium Silicate were applied to the closely clipped intact abdominal skin and the skin was exposed for 24 h. After the 24 h, the binders were removed and any residual chemical was removed by washing. The animals were observed for 14 days for toxicity. No signs of toxicity were apparent in any of the animals. The 2.0 ratio material produced severe, irreversible erythema and edema at the test site; while the 2.4 ratio material caused more moderate, reversible irritation at the test site. The acute rabbit dermal LD₅₀ was >4640 mg/kg (Rhone-Poulenc 1971b).

TABLE 6
Potassium Silicate: acute dermal irritation in rabbits (EUCLID 2000)

Method	Result	Remarks
OECD Guideline 404 "Acute Dermal Irritation/Corrosion"	Nonirritating	Diluted Potassium Silicate solution Molar ratio = 3.4 Concentration = 8.5-9%
OECD Guideline 404 "Acute Dermal Irritation/Corrosion"	Nonirritating	Diluted Potassium Silicate solution Molar ratio = 3.9 Concentration = 7-7.5%

TABLE 7
Sodium Metasilicate: dermal irritancy (Nixon, Tyson, and Wertz 1975)

Concentration of detergent (w/v aqueous)	Animal species	Mean scores			Tissue destruction		Irritancy judgement
		Intact	Abraded	PII	Intact	Abraded	
50%	Rabbit	>6.8	>8.0	>7.4	5/5	5/5	Corrosive
50%	Guinea pig	0.0	0.6	0.3	0/6	0/6	Negligible

Three detergents containing Sodium Silicate (7% in a high-carbonate detergent, 13% in a low-12 carbonate detergent, and 6% in a phosphate detergent) were applied to intact and abraded skin of rabbits and guinea pigs for four hours. Skin responses were graded at 4, 24, and 48 h after the patch applications. The results from this study are presented in Table 8 (Nixon, Tyson, and Wertz 1975).

In a single insult occlusive patch test, nine rabbits were treated with a skin freshener that contained 10% of a 40% aqueous solution of Sodium Silicate. The compound had a typical weight ratio of SiO₂/Na₂O of 3.25. The skin irritation potential of the test material was nonirritating (Cosmetic, Toiletry, and Fragrance Association [CTFA] 1979a).

Patch tests were performed using three female Hartley guinea pigs. Occlusive patches containing 20% Sodium Silicate were applied to the shaved backs of the three animals. Erythema was detected 48 h later but did not progress to ulceration. Pathological findings at the occlusive patch test site included dyskeratotic cells in the epidermis and polymorphonuclear leukocytic infiltration around the blood vessels (Tanka, Miyachi, and Horio 1982).

A summary of information on Sodium Silicate put together by European companies (EUCLID 2000) included the skin irritation data shown in Table 9.

Immunomodulation

The National Toxicology Program (NTP) (2001) evaluated Sodium Metasilicate as an immunomodulatory agent when applied to female BALB/c mice in a mouse ear swelling test and

local lymph node assay (LLNA) to measure contact hypersensitivity. Concentrations used in the contact hypersensitivity assays were determined by irritancy testing. The minimal irritating concentration was found to be 6% and the maximal nonirritating concentration was 4%. The Sodium Metasilicate concentrations were 0.4%, 2%, and 4% for the sensitization phase, and 6% for the challenge phase. In the LLNA, mice were sensitized to 2%, 4%, and 6% Sodium Metasilicate. 1-Fluoro-2,4-dinitrobenzene (DNFB) was used as a positive control at a concentration of 0.15% for the irritancy test and LLNA, and 0.20% for the swelling test. An evaluation of lymph node subpopulations, cytokine mRNA, and serum immunoglobulin E (IgE) levels was also conducted.

Dermal exposure to (2% to 6%) Sodium Metasilicate did not produce cell proliferation in the draining lymph nodes as measured by the LLNA. However, a delayed-type hypersensitivity (DTH) response was observed when mice were sensitized on the back with 4% Sodium Metasilicate, then challenged on the ear with 6% Sodium Metasilicate. The positive control, DNFB, induced cell proliferation in the draining lymph nodes, and elicited a DTH response. Lymph node subpopulations were also altered by treatment with Sodium Metasilicate. Only B220+Ig+ lymph nodes were shown to increase when the data were presented as a percentage of the total lymph node count. The response was observed at concentrations as low as 4%. An evaluation of the cytokine mRNA revealed an increase in the expression of interferon (IFN)- γ , tumor necrosis factor (TNF)- β , and migration inhibitory factor (MIF) mRNAs. No change in total serum IgE levels was detected (NTP 2001).

TABLE 8
Sodium Silicate: dermal irritancy (Nixon, Tyson, and Wertz 1975)

Detergent type (Sodium Silicate concentration)	Concentration of detergent (w/v aqueous)	Animal species	Mean scores			Tissue destruction		Irritancy judgement
			Intact	Abraded	PII	Intact	Abraded	
High carbonate (7%)	50%	Rabbit	0.9	2.6	1.7	0/6	0/6	Negligible
	50%	Guinea pig	0.0	0.4	0.2	0/6	0/6	Slight
Low carbonate (13%)	50%	Rabbit	0.7	0.8	0.8	0/6	0/6	Slight
	50%	Guinea pig	0.1	1.0	0.5	0/6	0/6	Slight
Phosphate (6%)	50%	Rabbit	1.2	>5.6	>3.4	0/5	2/5	Moderate
	50%	Guinea pig	0.2	1.0	0.6	0/6	0/6	Slight

TABLE 9
Sodium Silicate acute dermal results in rabbits (EUCLID 2000)

Method	Result
Undiluted substance (0.5 ml) applied for 4 h; molar ratio of 3.45; concentration of 35%	Nonirritating
0.5 g substance moistened with physiological saline applied to intact abraded skin for 24 h; molar ratios of 2.9 and 3.2; concentrations of 43%, 36%, and 80%	Irritating; the PII was 3, 3, 0 respectively for 43%, 36%, and 80%
Same application, but molar ratios of 2.4 and 3.2, and concentrations of 44% and 38%	Irritating
Same application, but pH 13.6 material; molar ratio of 1.6; concentration of 52%	Corrosive
0.5 ml solution of pH 12 with a molar ratio of <2	Corrosive
A powder product—2:1 dilution with water; molar ratio was 2; concentration was 66.6%	Nonirritating
Undiluted substance (0.5 ml) applied for 4 h; molar ratio was 3.91; concentration was 28%	Nonirritating
Same application, but molar ratio was 2.83 and concentration was 45%	Slightly irritating
Same application, but molar ratio was 2.09 and concentration was 55%	Moderately irritating
Same application, but molar ratio was 3.3 and concentration was 38%	Slightly irritating
Same application, but molar ratio was 2.09 and concentration was 55%	Slightly Irritating
Same application, but molar ratio was 2.4 and concentration was 40%	Irritating
Same application, but molar ratio was 2 and concentration was 41%	Irritating
The powder was applied dry. The molar ratio was 2	Nonirritating
Molar ratio of 1.6 and concentration of 53.5%	Corrosive
Molar ratio of 3.4 and concentration of 34.5%	Slightly irritating

Ocular Irritation

Potassium Silicate

A summary of information on Potassium Silicate put together by European companies (EUCLID 2000) included the ocular irritation data shown in Table 10.

Sodium Metasilicate

Sodium Metasilicate (42.4% H₂O) was tested in acute ocular irritation studies that were in accordance with the procedure outlined in the Code of Federal Regulations (21CFR191.12.1). Six New Zealand rabbits were exposed to 0.1 ml in one eye; the other eye served as a control. The sample was corrosive to the eye; total destruction of the eye of all the test animals was observed (Rhone-Poulenc, 1971b).

Sodium Silicate

Sodium Silicate ratios (2.0: 1.0 and 2.4:1.0 Na₂O with 19.5% H₂O) were tested in acute ocular irritation studies that were in accordance with the procedure outlined in the Code of Federal Regulations (21CFR191.12.1). Six New Zealand rabbits were

exposed to 0.1 ml in the conjunctival sac of one eye; the other eye served as a control. The 2.0 ratio material produced corneal opacity with scar tissue formation in four of the six rabbits. The remaining two had severe iritis and conjunctivitis. The 2.0 ratio material was classified as corrosive. The 2.4 ratio material produced conjunctivitis, moderate iritis, and two of six test rabbits had slight corneal opacity. Sodium Silicate was classified as a severe ocular irritant (Rhone-Poulenc 1971b).

A skin freshener (10% of a 40% aqueous solution of Sodium Silicate) was tested in a Draize eye irritation study in six rabbits. The compound had a typical weight ratio of SiO₂/Na₂O of 3.25. No eye irritation potential as judged by the Draize classification of eye irritation was demonstrated in this study (CTFA 1979b).

A summary of information on Sodium Silicate put together by European companies (EUCLID 2000) included the ocular irritation data shown in Table 11.

GENOTOXICITY

Sodium Metasilicate

DNA damage and repair assays without metabolic activation were conducted on *Bacillus subtilis* recombination-repair-deficient and wild-type strains. Sodium Metasilicate at concentrations of 0.005–0.5 M was not genotoxic (Kada, Brun, and Marcovich 1960).

Sodium Silicate

Strains B/Sd-4/1,3,4,5 and B/Sd-4/3,4 of *Escheria coli* were used to study the mutagenic action of Sodium Silicate (Demerec, Bertani, and Flint 1951). The streptomycin-dependent bacteria

TABLE 10

Potassium Silicate: ocular irritation in rabbits (EUCLID 2000)

Method	Result
Diluted solution; molar ratio = 3.9; concentration = 7%–7.5%	Nonirritating
Diluted solution; molar ratio = 3.4; concentration = 8.5%–9%	Nonirritating

TABLE 11
Sodium Silicate: Draize ocular irritation in rabbits (EUCLID 2000)

Method	Result	Remark
Molar ratios of 1 and 2; concentrations of 10% and 8%	Irritating	Sodium Silicate solutions of less than 10% are irritating but not highly irritating.
Molar ratios of 2 and 2.9; concentrations of 44% and 43%	Highly irritating	Concentrated solutions of molar ratios >2.9 are severely irritating.
Molar ratio of 3.2; concentration of 36%	Nonirritating	

(Sd-4) were treated with 0.025%, 0.01%, 0.05%, 0.1%, 0.15%, or 0.3% Sodium Silicate for three hours at 37°C. The control suspension was distilled water instead of streptomycin. At the end of treatment, both treated and control suspensions were assayed on streptomycin-agar plates. Samples from the suspensions (0.1 ml) were also plated on streptomycin-free plates, incubated for 6 days, and the frequency of mutants was calculated. Sodium Silicate was nonmutagenic.

REPRODUCTIVE AND DEVELOPMENTAL TOXICITY

Groups of three adult albino rats were injected intratesticularly and subcutaneously with doses of 0.08 mM/kg Sodium Silicate. By the testicular route, the left testis was treated and the right testis served as the control. The rats were killed 2, 7, and 30 days after injection. The testis and the spermatozoa were prepared for microscopic examination. No morphological changes were seen in the testis at anytime after either of the Sodium Silicate injections. No effect on the residual spermatozoa in the ductus deferens was apparent either (Kamboj and Amiya 1964).

As described earlier, Smith et al. (1973) added a Sodium Silicate solution to the drinking water containing 600 and 1200 ppm of added silica and given to groups of six weanling male and six female Sprague-Dawley rats. Control groups received no Sodium Silicate in their drinking water. At 4 months of age, the rats of treatment groups were mated. At 600 ppm and 1200 ppm, the treated water decreased the numbers of offspring born to 67% and 80% of controls, respectively. Also these treatments decreased the numbers of surviving offspring until weaning (3 weeks) to 46% and 24% of the control values.

CLINICAL ASSESSMENT OF SAFETY

Dermal Irritation

Sodium Metasilicate

A Sodium Metasilicate/carbonate granular detergent was applied to intact and abraded skin of humans for four hours. Each subject afforded eight test sites aligned four on each side of the back about 5 cm from the midline. Sites were vertically spaced 3 cm apart in the area between the scapula and the waist. Erythema and edema were graded 4, 24, and 48 h after the patch applications. Primary irritation indices (PIIs) were calculated by

averaging the scores for all test sites. The detergent contained 37% Sodium Metasilicate and was applied at a concentration of 50% (w/v aqueous). The results from this study are presented in Table 12. The PII was >3.6 and the material was judged to be a severe irritant (Nixon, Tyson, and Wertz 1975).

Clairol (2000a) studied the irritancy of Sodium Metasilicate in a modified soap chamber test. Two hair color kits including a developer, activator, and lightener were tested. Sodium Metasilicate was a component of the activator at a concentration (w/w) of 13.5% in both kits; on-head concentrations were 1.34% (kit 1) and 1.43% (kit 2). The two test patches, a positive-control patch dosed with 2% sodium lauryl sulfate (SLS), and a negative-control patch dosed with deionized water were applied to the lower back of nineteen subjects for approximately 4 h. The test sites were graded for erythema, edema, burning, stinging, and itching approximately 4 h after application (20 min after removal) and approximately 28 h after application (24 h after removal). A separate 24-h 0.75% SLS reactivity patch was applied to the upper back and graded at the 28-h time point only.

No fissuring or scaling was observed over the course of the study. The kit 1 mean erythema + edema grade at 4 h was 1.00 and for 28 h was 0.50. For kit 2, the mean erythema + edema scores at 4 h was 0.95 and for 28 h was 0.53. The positive control had a 28-h erythema + edema grade of 2.92. No adverse events occurred during the course of the study (Clairol 2000a).

In a second modified soap chamber test, Clairol (2000b) tested Sodium Metasilicate to determine the incidence and severity of irritation. Procedures stated in the above study were followed. Twenty-one subjects completed this study. Sodium Metasilicate was a part of the activator in the hair coloring system and concentrations (w/w) were 13.5% in the activator and 2.58% on the head.

No burning or itching was recorded. The mean 6-h and 24-h erythema + edema scores were 1.36 and 0.56, respectively.

TABLE 12
Sodium Metasilicate: human dermal irritancy (Nixon, Tyson, and Wertz 1975)

End point	Intact	Abraded
Mean irritation scores	>3.0	>4.2
Tissue destruction	0/8	1/8

The reactivity control containing 0.75% SLS had a 28-h mean erythema + edema score of 0.89 (Clairol 2000b).

L'Oreal (2000a) assessed 15 bleach formulations in the elbow crease test. Experimental groups comprised 20 to 40 healthy adults. Approximately 0.7 ml of mixed product (developer + activator or developer + base + activator) was applied in the elbow creases on 40 cm² for 50 min without occlusion. The test sites were evaluated for erythema, edema, and vesicles by a trained grader using a 4-point visual scoring system for each parameter. Time points for evaluation were 5 min, 4 h, and 24 h following the removal of the products by rinsing. The Sodium Metasilicate concentrations in the activators and in the product mixtures ranged from 3.4% to 14% and 1% to 7%, respectively.

Under the study conditions, all products induced low grade irritation: almost exclusively mild erythema and only occasionally moderate erythema at 5 min. Observable changes subsided quickly after product removal, leaving slight erythema at 1 h in only a few volunteers. No correlation could be observed between Sodium Metasilicate concentrations and the irritation potential of the product (L'Oreal, 2000a).

L'Oreal (2000b) tested 32 hair bleaches in semioccluded patch tests. Sodium Metasilicate concentrations ranged from 3.4% to 14% in the activators and from 0.75% to 6.8% in mixed products; 0.2 ml of the mixed product were applied under patch tests for 1 h and 15 min on the back. Experimental groups were comprised of 25 healthy adults. Test sites were evaluated for erythema, edema, and vesicles using a 7-point visual scoring system encompassing all the parameters at 30 min and 24 h following the removal of the products by rinsing. Mean irritation scores were calculated for each time point.

Under the study conditions, Sodium Metasilicate produced only mild and transient irritation under exaggerated conditions of application. Irritation scores appeared to be independent of silicate concentration (L'Oreal 2000b).

Sodium Silicate

Nixon, Tyson, and Wertz (1975) applied three detergents containing Sodium Silicate to intact and abraded skin of humans for four hours. One sample contained 7% Sodium Silicate in a high-carbonate detergent, the second contained 13% in a low-carbonate detergent, and the third contained 6% in a phosphate detergent. Eight subjects were tested for each detergent. Each subject afforded eight test sites aligned four on each side of the

back about 5 cm from the midline. Sites were vertically spaced 3 cm apart in the area between the scapula and the waist. Erythema and edema were graded 4, 24, and 48 h after the patch applications. PIIs were calculated by averaging the scores for all test sites.

The authors concluded that each sample had negligible irritancy. The results from this study are presented in Table 13 (Nixon, Tyson, and Wertz 1975).

Hill Top Research, Inc. (1979) conducted a study of cumulative irritant properties of a series of test materials with 10% of a 40% aqueous solution of Sodium Silicate on 12 male and female panelists. The test material was applied to the backs of the panelists in randomized manner. Each sample was reapplied to the same test site on each panelist for the remainder of the study (21 consecutive days) or until the max irritation score was reached. If the max score was reached, the patch was omitted and the patch area was scored for residual irritation for the next three scoring dates.

The test patches were removed by the panelists 23 h after application. The panelists were instructed to take a bath or shower immediately following removal of the patches and to keep the patch areas dry at other times. Approximately 0.3 ml of each sample was applied to each patch. Reactions to the test samples were scored 24 h after application (1 h after patch removal). Scores were classified as following: 0–49 (mild material, no irritation); 50–199 (probably mild in normal use); 200–449 (possibly mild in normal use); 450–580 (experimental cumulative irritant); 581–630 (experimental primary irritant).

The total score calculated for the panelists was 155, classifying the test compound as probably a mild irritant in normal use (Hill Top Research, Inc. 1979).

A skin freshener (10% of a 40% aqueous solution of Sodium Silicate) was evaluated via a 4-day minicumulative irritancy assay. A currently marketed product was used as a mildness frame of reference. Both materials were tested full strength under occlusive patch conditions in 20 humans. The PII for the test product was 0.5 and was 0.88 for the currently marketed product. The test product exhibited acceptable irritancy results and was significantly milder than the reference control (CTFA 1989).

Clairol (2000c) studied the irritancy of Sodium Silicate in a modified soap chamber test. Two hair color kits including a developer, activator, and lightener were tested. Sodium Silicate

TABLE 13
Sodium Silicate: human dermal irritancy (Nixon, Tyson, and Wertz 1975)

Detergent type (Sodium Silicate concentration)	Concentration of detergent (w/v aqueous)	Mean scores			Tissue destruction		Irritancy judgement
		Intact	Abraded	PII	Intact	Abraded	
High carbonate (7%)	50%	0.0	0.0	0.0	0/8	0/8	Negligible
Low carbonate (13%)	50%	0.0	0.2	0.1	0/8	0/8	Negligible
Phosphate (6%)	50%	0.0	0.4	0.3	0/8	0/8	Negligible

was a component of the activator at 35.75% (w/w) with on the head concentrations of 4.26% (kit 1) and 7.61% (kit 2). The two patches listed before, along with a positive-control patch dosed with 2% SLS and a negative-control patch dosed with deionized water, were applied to the lower back of 19 subjects for approximately 4 h. The test sites were graded for erythema, edema, burning, stinging, and itching approximately 4 h after application (20 min after removal) and approximately 28 h after application (24 h after removal). A separate 24-h 0.75% SLS reactivity patch was applied to the upper back and graded at the 28-h time point only.

No fissuring or scaling was observed over the course of the study. The mean erythema + edema scores at 4 and 28 h were 1.24 and 0.45, respectively, for kit 1; the mean erythema + edema scores at 4 and 28 h were 1.26 and 0.53, respectively, for kit 2. The positive control containing 0.75% SLS had a mean 28-h erythema + edema score of 2.92. No adverse events occurred during the course of the study (Clairol 2000c).

In a second modified soap chamber test, Sodium Silicate was tested to determine the incidence and severity of irritation. Procedures stated in the Clairol 2000 study were followed. Twenty-one subjects completed this study. Sodium Silicate was a part of the activator in the hair coloring system and concentrations (% w/w) in the activator and on the head were 35.75 and 2.13, respectively. No burning or itching was recorded. The mean 6-h and 24-h erythema + edema scores were 0.58 and 0.19, respectively. The reactivity control containing 0.75% SLS had a 28-h mean erythema + edema score of 0.89 (Clairol 2000d).

Sodium Silicate was evaluated in an elbow crease test previously described in the clinical dermal irritation section under Sodium Metasilicate (L'Oreal 2000). Sodium Silicate was present in only two activators at concentrations of 10.6% and 29.6% (2.1% and 8.5% respectively, in the product mixture). Under the study conditions, all products induced low-grade irritation: almost exclusively mild erythema and only occasionally moderate erythema at 5 min. Observable changes subsided quickly after product removal, leaving slight erythema at 1 h in only a few volunteers (L'Oreal, 2000c).

Sodium Silicate was evaluated in semiocclusive patch tests previously described in the clinical dermal irritation section under Sodium Metasilicate (L'Oreal 2000b). Sodium Silicate concentrations ranged from 10.6% to 29.6% in the activators and 1.2% to 6.5% in the mixed products. Under the conditions of this study, all products induce only mild and transient irritation under exaggerated conditions of application. Irritation scores appeared to be independent of silicate concentration (L'Oreal 2000d).

Skin Sensitization

To determine its capacity to induce skin irritation and allergic sensitization, 10% of a 40% aqueous solution of Sodium Silicate was used in a repeat-insult predictive patch test. Ten patches were applied to the upper backs of 94 panelists. Five

were placed on the right side and five were placed on the left side. The sample was applied to all panelists for 24 h every Monday, Wednesday, and Friday for 3 consecutive weeks. The samples were applied to the same site each time. The challenge was conducted in week 6 of the study. A single patch was applied to a previously unpatched site. These patches were removed 24 h following application. Reactions were scored 24 and 48 h after removal. Subjects exhibiting challenge patch reactions indicative of possible induced sensitization participated in follow-up testing after 1 week. Within the limits imposed by the sample size and the test procedure itself, the test material did not exhibit any potential for inducing allergic sensitization (CTFA 1979c).

Case Reports

Sodium Metasilicate

Colloidal Sodium Metasilicate, 0.5 L, was orally ingested and led to the patient's death within 1 to 1.5 h. At autopsy, alkali burns were present in the gastric mucosa; and the stomach contained a small amount of liquid with a pH of 11.5. The liquid was chemically analyzed and was found to be condensed "waterglass." At microscopic examination of the lungs, numerous bronchioles and alveoli were filled with amorphous Sodium Metasilicate. Due to the obstruction of the airways, inhibition of alveolar gas diffusion could have been the cause of death. Liquid Sodium Metasilicate solidification occurred in the lungs by means of carbonic acid of expired air. This occurred due to the fact that Sodium Metasilicate starts to solidify at pH 11.3. Gastric secretions had lowered the pH of the Sodium Metasilicate from 12.5 to 11.5 (Sigrist and Flury 1985).

Sodium Silicate

A man who drank 200 ml of a neutralized Sodium Silicate solution (estimated to contain about 100 g of solid Sodium Silicate or more than 1 g/kg) demonstrated prompt vomiting, diarrhea, and gastrointestinal bleeding, and later had albumin, acetone, "sugar," and blood in the urine. The patient recovered even at this dose. The authors noted that such a neutral silicate would be expected to be less corrosive than unneutralized, strongly alkaline Sodium Metasilicate (Eichhorst 1921).

Tanka, Miyachi, and Horio (1982) reported a case involving a 57-year-old man exposed to Sodium Silicate. At first examination, the eruption consisted of lichenified lesions with hyperpigmentation and four ulcers on the dorsum of the left hand. The lesions appeared oval to round and punched out with irregular and elevated margins. Urticarial wheals were not present and axillary lymph nodes were not palpable. A patch test was performed on the flexor surface of the skin using 20% aqueous solution of Sodium Silicate. Within 24 h, macular erythema and papules with itching were noted. A wheal appeared at the application site immediately after the patch was removed at 24 h. The wheal was not seen after a 15-min patch test. Itchy erythema progressed into ulcer formation after 1 week. A scratch test was also performed and resulted in wheal formation after

15 min. A skin biopsy of a lichenified site near an ulcer revealed spongiosis and exocytosis with individual cell keratinization in the upper epidermis. Patchy perivascular cell infiltration of polymorphonuclear leukocytes also was noted. The patch test biopsy specimen had similar lesions.

To further investigate these findings, these authors performed patch tests with 20% Sodium Silicate on the flexor surface of 30 people. After 48 h, positive reactions were noted in 22 of the volunteers. Erythema similar to that of the case study was seen. No ulcers formed. Scratch tests were also performed on the same volunteers with 20% Sodium Silicate. No wheal formation was observed (Tanka, Miyachi, and Horio, 1982).

SUMMARY

This report provides a review of the safety of Potassium Silicate, Sodium Metasilicate, and Sodium Silicate. These ingredients combine metal cations (potassium or sodium) with silica to form inorganic salts.

Aqueous solutions of Sodium Silicate species are a part of a chemical continuum of silicates based on an equilibrium of alkali, water, and silica. pH determines the solubility of silica and, together with concentration, the degree of polymerization.

These ingredients function as corrosion inhibitors in cosmetics; Sodium Metasilicate also functions as a chelating agent and Sodium Silicate as a buffering and pH adjuster. Sodium Metasilicate is currently used in 168 formulations at concentrations ranging from 13% to 18%. Sodium Silicate is currently used in 24 formulations at concentrations ranging from 0.3% to 55%.

Potassium Silicate and Sodium Silicate were reported as being used in industrial cleaners and detergents. Sodium Metasilicate is a GRAS food ingredient.

Sodium Silicate administered orally acts as a mild alkali and was readily absorbed from the alimentary canal and excreted in the urine. Urinary excretion of Sodium Silicate given orally to rats at 40 and 1000 mg/kg was 18.9% and 2.8%, respectively.

The toxicity of these silicates has been related to the molar ratio of $\text{SiO}_2/\text{Na}_2\text{O}$ and the concentration. The acute oral LD_{50} of Sodium Metasilicate ranged from 847 mg/kg in male rats to 1349.3 mg/kg in female rats, and from 770 mg/kg in female mice to 820 mg/kg in male mice. Gross lesions of variable severity were found in the oral cavity, pharynx, esophagus, stomach, larynx, lungs, and kidneys of dogs receiving 0.25 g/kg or more of a commercial detergent containing Sodium Metasilicate. Similar lesions were seen in pigs given the same detergent and dose as in the previous study. Male Sprague-Dawley rats orally administered 464 mg/kg of a 20% solution containing either 2.0 or 2.4 ratio to 1.0 ratio of sodium oxide showed no signs of toxicity, whereas doses of 1000 and 2150 mg/kg produced gasping, dyspnea, and acute depression.

Beagle dogs fed 2.4 g/kg/day of Sodium Silicate for 4 weeks had gross renal lesions but no impairment of renal function. In a oral subchronic study (drinking water containing 600 and 1200 ppm of added silica), there were body weight gains in

male rats, but decreases in female rats. No apparent effect of the treatment in the drinking water was found on the longevity in rats having started treatment after weaning.

Intraperitoneal injections of a neutralized 2% solution of Sodium Metasilicate in white rats resulted in a decrease in spleen weight and relative enlargement of the kidneys.

Dermal irritation of Potassium Silicate, Sodium Metasilicate, and Sodium Silicate ranged from negligible to severe, depending on the species tested and the molar ratio and concentration tested.

Sodium Metasilicate was negative in the local lymph node assay, but a delayed-type hypersensitivity response was observed in mice.

Potassium Silicate was nonirritating in two acute eye irritation studies in rabbits. Sodium Metasilicate (42.4% H_2O) was corrosive to the rabbit eye. Sodium Silicate was a severe eye irritant in acute eye irritation studies. A skin freshener (10% of a 40% aqueous solution) containing Sodium Silicate was nonirritating. Sodium Silicate in another three Draize eye irritation studies was highly irritating, irritating, and nonirritating, respectively.

Sodium Metasilicate was nonmutagenic in a DNA damage and repair assay without metabolic activation using *B. subtilis*. Sodium Silicate was nonmutagenic in studies using *E. coli* stains B/Sd-4/1,3,4,5 and B/Sd-4/3,4.

Rats given Sodium Silicate (600 and 1200 ppm of added silica) in the drinking water in reproductive studies produced a reduced number of offspring; to 67% of controls at 600 ppm and to 80% of controls at 1200 ppm. Three adult rats injected intratesticularly and subcutaneously with 0.8 mM/kg of Sodium Silicate showed no morphological changes in the testes and no effect on the residual spermatozoa in the ductus deferens.

Sodium Metasilicate/carbonate detergent (37% Sodium Metasilicate) mixed 50/50 with water was considered a severe skin irritant when tested on the intact and abraded human skin. Detergents containing 7%, 13%, and 6% Sodium Silicate mixed 50/50 with water, however, were negligible skin irritants to intact and abraded human skin. A 10% of a 40% aqueous solution of Sodium Silicate was negative in a repeat-insult predictive patch test in humans. The same aqueous solution of Sodium Silicate was considered mild under normal use conditions in a study of cumulative irritant properties. Sodium Metasilicate and Sodium Silicate were studied in modified soap chamber tests. No burning or itching was observed and low erythema + edema scores were noted. Sodium Metasilicate and Sodium Silicate, tested in elbow crease studies and semioccluded patch tests, produced low grade and transient irritation.

Colloidal Sodium Metasilicate was fatal to one man and neutralized Sodium Silicate produced vomiting, diarrhea, and gastrointestinal bleeding in another man in separate case reports.

DISCUSSION

The Cosmetic Ingredient Review (CIR) Expert Panel determined that the data provided in this report are sufficient to

address the safety of the tested ingredient Potassium Silicate, Sodium Metasilicate, and Sodium Silicate. The Panel recognized the irritation potential of these ingredients, especially in leave-on products. However, because these ingredients have limited dermal absorption and Sodium Metasilicate is a GRAS direct food substance, the Panel deemed the ingredients safe as currently used, when formulated to avoid irritation.

CONCLUSION

Based on the available data contained within this report, the CIR Expert Panel concluded that Potassium Silicate, Sodium Metasilicate, and Sodium Silicate are safe for use in cosmetic products in the practices of use and concentration described in this safety assessment, when formulated to avoid irritation.

REFERENCES

- Alexander, A. G. 1968. In vitro effects of silicon on the action of sugarcane acid invertase. *J. Agr. Univ. Puerto Rico* 52:311-322.
- Benke, G. M., and T. W. Osborn. 1979. Urinary silicon excretion by rats following oral administration of silicon compounds. *Food Cosmet. Toxicol.* 17:123-127.
- Budavari, S., ed. 1989. *The Merck Index. An encyclopedia of chemicals, drugs, and biologicals*, 11th ed. Rahway, NJ: Merck & Co., Inc.
- Clairol. 2000a. Sodium metasilicate modified soap chamber test (00041). Unpublished data submitted by CTFA. (207 pages.)²
- Clairol. 2000b. Sodium metasilicate modified soap chamber test (97057). Unpublished data submitted by CTFA. (52 pages.)²
- Clairol. 2000c. Sodium silicate modified soap chamber test (00041). Unpublished data submitted by CTFA. (207 pages.)²
- Clairol. 2000d. Sodium silicate modified soap chamber test (97057). Unpublished data submitted by CTFA. (52 pages.)²
- Cosmetic, Tolietry, and Fragrance Association (CTFA). 1979a. Primary skin irritation test of sodium silicate. Unpublished data submitted by CTFA. (1 page.)²
- CTFA. 1979b. Draize eye irritation test of sodium silicate. Unpublished data submitted by CTFA. (1 page.)²
- CTFA. 1979c. Allergic contact sensitization test of sodium silicate. Unpublished data submitted by CTFA. (9 pages.)²
- CTFA. 1989. 4-day mini-cumulative irritancy test of sodium silicate. Unpublished data submitted by CTFA. (2 pages.)²
- CTFA. 1999. Ingredient use data. Unpublished data submitted by CTFA. (1 page.)²
- CTFA. 2000a. Technical summary. Unpublished data submitted by CTFA (2 pages.)²
- CTFA. 2000b. Ingredient use data. Unpublished data submitted by CTFA (1 page.)²
- Demerec, M., G. Bertani, and J. Flint. 1951. A survey of chemicals for mutagenic action on *E. coli*. *Am Natur.* 85:119-136.
- Eichhorst, H. 1921. Water-glass poisoning. *JAMA.* 76:275-276.
- EUCLID. 2000. Industry data sheet for sodium silicate. Unpublished data submitted by CTFA. (58 pages.)²
- European Economic Community (EEC). 1999. EEC Cosmetics Directive 76/768/EEC, as amended Annexes I-VII. Brussels: EEC.
- Falcone, J. S. ed., 1982. *Silicon compounds: Kirk-othmer encyclopedia of chemical technology*, Vol. 20, 3rd ed., New York: John Wiley & Sons.
- Federation of American Societies for Experimental Biology (FASEB). 1981. Evaluation of the health aspects of sodium metasilicate and sodium zinc metasilicate as food ingredients. NTIS report No. PB82160367.
- Food and Drug Administration (FDA). 2001. Frequency of use of cosmetic ingredients. *FDA database*. Washington, DC: FDA.
- Gottschalck, T. E., and G. N. McEwen, Jr., eds. 2004. *International cosmetic ingredient dictionary and handbook*, 10th ed., Vol. 1-4. Washington, DC.: CTFA.
- Hill Top Research, Inc. 1979. The study of cumulative irritant properties of a series of test materials. Unpublished data submitted by CTFA. (5 pages.)²
- Ito, R., S. Saito, S. Nakai, Y. Tokunaga, T. Kubo, K. Hiraga, S. Iwahara, and Y. Koichi. 1986. Safety of anticorrosives in building water-pipe metal inhibitors sodium polyphosphate and sodium meta-silicate. *Toxicol. Lett.* 31:44.
- Kada, T., E. Brun, and H. Marcovich. 1960. Comparison de l'induction de mutants prototrophs par les rayons X et UV chez *Eshcherichia coli B/r try-*. *Ann. Inst. Pasteur* 99:547-566.
- Kamboj, V. P., and B. K. Amiya. 1964. Antitesticular effect of metallic and rare earth salts. *J. Reprod. Fertil.* 7:21-28.
- Kayongo-Male, H., and X. Jia. 1999. Silicon bioavailability studies in young rapidly growing rats and turkeys fed semi-purified diets. *Biol. Trace Element Res.* 67:173-186.
- Kind, P. R. N., E. J. King, V. Pash, W. Roamn, and E. Schmidt. 1954. Inhibition of enzymes by silicic acid. *Biochem J.* 56:xliv.
- Lide, D. R., ed. 1993. *CRC handbook of chemistry and physics*, 74th ed. Boca Raton, FL: CRC Press.
- Liesch, M., B. Doring, T. A. Donnelly, P. Logemann, L. A. Rheins, and H. Spielmann. 1995. Application of the human dermal model Skin² ZK 1350 to phototoxicity and skin corrosivity testing. *Toxic in Vitro* 9:557-562.
- L'Oreal. 2000a. Elbow crease test with sodium metasilicate. Unpublished data submitted by CTFA. (6 pages.)²
- L'Oreal. 2000b. Semi-occluded patch test with sodium metasilicate. Unpublished data submitted by CTFA. (6 pages.)²
- L'Oreal. 2000c. Elbow crease test with sodium silicate. Unpublished data submitted by CTFA. (6 pages.)²
- L'Oreal. 2000d. Semi-occluded patch test with sodium silicate. Unpublished data submitted by CTFA. (6 pages.)²
- Ministry of Health, Labor, and Welfare (MHLW). 2000. Pharmaceutical and Medical Safety Bureau Notification No. 990. September 29. Ministry of Health, Labor and Welfare, Pharmaceutical and Medical Safety Bureau, Inspection and Guidance Division, 2-2, 1-chrome, Kasumigaseki, Chiyoda-ku, Tokyo 100-8045, Japan.
- Muggenberg, B. A., J. L. Mauderly, F. F. Hahn, S. A. Silbaugh, and S. A. Felicetti. 1974. Effects of the ingestion of various commercial detergent products on beagle dogs and pigs. *Toxicol. Appl. Pharmac.* 30:134.
- Nanetti, L. 1973. Su taluni effetti lesivi del silicato di sodio. *Zacchia.* 9:96-128.
- National Toxicology Program (NTP) 2001. Final report on the assessment of contact hypersensitivity to sodium metasilicate in BALB/c female mice. Unpublished data submitted by CTFA. (21 pages.)²
- Newberne, P. M., and R. B. Wilson. 1970. Renal damage associated with silicon compounds in dogs. *Proc. Nat. Acad. Sci. U.S.A.* 65:872-875.
- Nikitakis, J. M., and G. N. McEwen, Jr., eds. 1990. *CTFA Compendium of cosmetic ingredient composition—specifications*. Washington, DC: CTFA.
- Nixon, G. A., C. A. Tyson, and W. C. Wertz. 1975. Interspecies comparisons of skin irritancy. *Toxicol. Appl. Pharmacol.* 31:481-490.
- O'Connor, T. L. 1961. The reaction rates of polysilicic acids with molybdc acid. *J. Phys. Chem.* 65:1-5.
- Registry of Toxic Effects of Chemical Substances (RTECS). 1999. Sodium Silicate entry. *RTECS database*. Bethesda, MD: National Library of Medicine.
- Reynolds, A. G., L. J. Veto, P. L. Sholberg, D. A. Wardle, and D. A. Haag. 1998. Use of potassium silicate for the control of powdery mildew [*Uncinula necator* (Schwein) Burrill] in *Vitis vinifera* L. Cultivar Bacchus. *Am. J. Enol. Viticulture.* 47:421-428.

² Available for Review: Director, Cosmetic Ingredient Review, 1101 17th Street, NW, Suite 310, Washington DC 20036-4702, USA.

- Rhone-Poulenc Inc. 1971a. Initial submission: Primary skin irritation of sodium hexametaphosphate, powdered, in rabbits with cover letter. NTIS report no. OTS0555931.
- Rhone-Poulenc Inc. 1971b. Initial submission: Comparative toxicology study of disilicates with cover letter dated 10/23/92. NTIS report no. OTS0571941.
- Rhone-Poulenc Inc. 1976. Initial submission: Toxicology lab report T-5362 with dry chlorecso with cover letter dated 10/16/92. NTIS report no. OTS0571654.
- Schwarz, K., and D. B. Milne. 1972. Growth promoting effects of silicon in rats. *Nature*. London 239:333-334.
- Shakhbazyan, F. A., and A. A. Karapetyan. 1963. A study of the toxic properties of sodium metasilicate. *Zh. Eksp. Klin. Med.* 3:85-87.
- Sigrist, T., and K. Flury. 1985. Death by peroral ingestion of soluble glass (sodium metasilicate). *Z. Recht. smed.* 94:245-250.
- Smith, G. S., A. L. Neumann, V. H. Gledhill, and C. A. Arzola. 1973. Effects of soluble silica on growth, nutrient balance, and reproductive performance of albino rats. *J. Anim. Sci.* 36:271-278.
- Tanka, T., Y. Miyachi, and T. Horio. 1982. Ulcerative contact dermatitis caused by sodium silicate. *Arch. Dermatol.* 118:518-520.

Amended Safety Assessment of Synthetically-Manufactured Amorphous Silica and Hydrated Silica as Used in Cosmetics

Status: Final Amended Report
Release Date: October 7, 2019
Panel Meeting Date: September 16-17, 2019

The 2019 Cosmetic Ingredient Review Expert Panel members are: Chair, Wilma F. Bergfeld, M.D., F.A.C.P.; Donald V. Belsito, M.D.; Curtis D. Klaassen, Ph.D.; Daniel C. Liebler, Ph.D.; James G. Marks, Jr., M.D.; Ronald C. Shank, Ph.D.; Thomas J. Slaga, Ph.D.; and Paul W. Snyder, D.V.M., Ph.D. The CIR Executive Director is Bart Heldreth, Ph.D. This safety assessment was prepared by Christina L. Burnett, Senior Scientific Analyst/Writer.

ABSTRACT

The Cosmetic Ingredient Review (CIR) Expert Panel (Panel) assessed the safety of synthetically-manufactured amorphous Silica and Hydrated Silica. The Panel considered the method of manufacture of these ingredients to be of significant importance when reviewing safety. Thus, the current assessment is exclusive to amorphous Silica and Hydrated Silica when manufactured via synthetic methods. Both of these ingredients are reported to function as abrasives, absorbents, anticaking agents, bulking agents, and opacifying agents in cosmetic products. The Panel reviewed relevant data, including frequency and concentration of uses. The Panel concluded that synthetically-manufactured amorphous Silica and Hydrated Silica are safe in the present practices of use and concentration when formulated to be non-irritating.

INTRODUCTION

This report assesses the safety of synthetically-manufactured amorphous Silica and Hydrated Silica as used in cosmetics. According to the web-based *International Cosmetic Ingredient Dictionary and Handbook* (wINCI; *Dictionary*; see Table 1), both of these ingredients are reported to function as abrasives, absorbents, anticaking agents, bulking agents, and opacifying agents in cosmetic products.¹ (Additional functions specific to each ingredient are described in Table 1.) These ingredients were previously reviewed in a report that was finalized in 2009; other ingredients from that report will be re-reviewed elsewhere. Therefore, the conclusion for this current report on synthetically-manufactured amorphous Silica and Hydrated Silica supersedes that previous conclusion just for these two ingredients.

The Panel considered the method of manufacture of these ingredients (whether synthetic or mined) to be of significant importance when reviewing safety. Thus, the current assessment is exclusive to amorphous Silica and Hydrated Silica when manufactured via synthetic methods.

This safety assessment includes relevant published and unpublished data that are available for each endpoint that is evaluated. Published data are identified by conducting an exhaustive search of the world's literature. A listing of the search engines and websites that are used and the sources that are typically explored, as well as the endpoints that CIR typically evaluates, is provided on the CIR website (<https://www.cir-safety.org/supplementaldoc/preliminary-search-engines-and-websites>; <https://www.cir-safety.org/supplementaldoc/cir-report-format-outline>). Unpublished data were provided by the cosmetics industry, as well as by other interested parties.

Some chemical and toxicological data on the synthetically-manufactured amorphous Silica and Hydrated Silica included in this safety assessment were obtained from assessments by the Organisation for Economic Co-Operation and Development Screening Information Data Sets (OECD SIDS)² and the European Centre for Ecotoxicology and Toxicology of Chemicals (ECETOC).³ These data summaries are available on the OECD SIDS and ECETOC websites, respectively, and when deemed appropriate, information from the summaries has been included in this report.

CHEMISTRY

Definition

Silica and Hydrated Silica, or silicon dioxide, are solids that can be derived from naturally-occurring minerals. However, in this safety assessment, only ingredients that are produced synthetically are being considered. Indeed, in the case of Silica and Hydrated Silica, these ingredients are more commonly prepared as such for commercial purposes. The definitions and functions of synthetically-manufactured amorphous Silica and Hydrated Silica are provided in Table 1.¹

Silica

Silica comprises silicon-oxygen tetrahedral units, in which a silicon atom is central within 4 oxygen atoms that are shared with adjacent silicon atoms.⁴ Various physical forms of Silica are caused by differences in the spatial relationships of the tetrahedral that determine physical characteristics. Amorphous Silica has an irregular tetrahedral pattern. Crystalline Silica (the safety of which is not be reviewed in this assessment) is polymorphic, where each variety has a characteristic regular 3-dimensional arrangement of the tetrahedral. As would be predicted from these descriptions, crystalline Silica has a well-defined x-ray diffraction pattern, whereas amorphous forms of Silica do not.

The CAS No. 7631-86-9 is a general CAS No. which includes all forms of silicas, including amorphous, crystalline, synthetic, and natural forms.² The amorphous forms of Silica may also be referred to as amorphous silicon oxide hydrate, silicic anhydride, silicon dioxide, and silicon dioxide, fumed.¹ Pyrogenic Silica is the current terminology for silicon dioxide, fumed.⁵ The CAS No. 112945-52-5 has been reported to be associated with synthetic pyrogenic Silica, whereas the CAS Nos. 67762-90-7; 68611-44-9; and 68909-20-6 have been reported to be associated with synthetic surface treated Silica.⁶

Hydrated Silica

Hydrated Silica may also be referred to as hydrosilicic acid, precipitated silica, silica gel, silica hydrate, silicic acid, silicic acid hydrate, silicon dioxide hydrate, synthetic amorphous silicon dioxide, and colloidal silica.^{1,7} The CAS No. 112926-00-8 has been reported to be associated with both synthetic precipitated silica and silica gel.⁶

Physical and Chemical Properties

Physical and chemical properties of synthetically-manufactured amorphous Silica are provided in Table 2.^{2,8-10} Silica has a melting point of approximately 1700 °C and water solubility of 15 - 68 mg/l at 20 °C.

Silica and Hydrated Silica

According to size distribution measurements taken by several manufacturers of various synthetic amorphous Silica raw materials, the median particle sizes are approximately between 6 - 682 μm .¹¹ Particle size was reported to range from as small as $< 1 \mu\text{m}$ to as large as 2060 μm ; data submitted to CIR reported that for 11 out of 20 samples, 0.15% to 80.1% of the particle measured 10 μm or less. However, these measurements will change once these ingredients are formulated in cosmetic products due to aggregation of the particles. These manufacturers also reported the size distribution of various synthetic amorphous Silica materials are approximately between 8 - 65 μm , with particle size ranges of approximately $< 1 - 344 \mu\text{m}$.

The *Food Chemicals Codex* states that Silica is a white, fluffy non-gritty powder of extremely fine particle size that is hygroscopic.¹² Silica absorbs moisture from the air in varying amounts. Amorphous silicas are composed of very fine particles (average of 20 μm) which tend to aggregate loosely in the air.¹³ Primary particles, or single particles, exist only in the colloidal form of Hydrated Silica.^{3,14} Aggregates assemble in chains (Silica; pyrogenic) or clusters (Hydrated Silica; precipitated and gel). Agglomerates are assemblies of aggregates, held together by strong physical adhesion forces and not in a dispersible nano-size ($< 100 \text{ nm}$).

The acidity of synthetic amorphous Silica is related to the number and reactivity of the silanol groups present on the solid Silica surface.¹⁵ Surface silanols ($\text{pK}_a = 7.1$) are more acidic than monosilicic acid ($\text{pK}_a = 9.8$). The acidity increases with the degree of polymerization. The surface of Silica may be made up of free silanol groups (isolated hydroxyls), hydrogen-bonded silanol groups (hydroxyl groups on adjacent surface silicon atoms), and siloxane groups. Amorphous Silica is capable of rehydroxylating in aqueous systems to form a high ratio of silanol to siloxane groups. Depending on the hydrophobic properties of the solvent, it may form a network-like structure through hydrogen bonding. This gives amorphous Silica gelling and thickening abilities in various solvent systems. Oxygen electron donors of compounds such as ethers, alcohols, and ketones or the nitrogen of amides and amines may interact through hydrogen bonding due to the acid dissociation constant of the silanol groups on the Silica surface. Esterification has been reported with a Si-O-C-R structure. A totally dehydrated Silica or a fully hydrated Silica has little or no adsorption of hydrophobic organic compounds.

Method of Manufacturing

Silica and Hydrated Silica

Amorphous Silica and Hydrated Silica, as used in cosmetics, are produced synthetically.^{2,3,6} A manufacturing process for Silica (pyrogenic form) is shown in Figure 1. Mean particle size, particle size distribution, and degree of aggregation and/or agglomeration can be determined by adjusting processing parameters.¹⁶

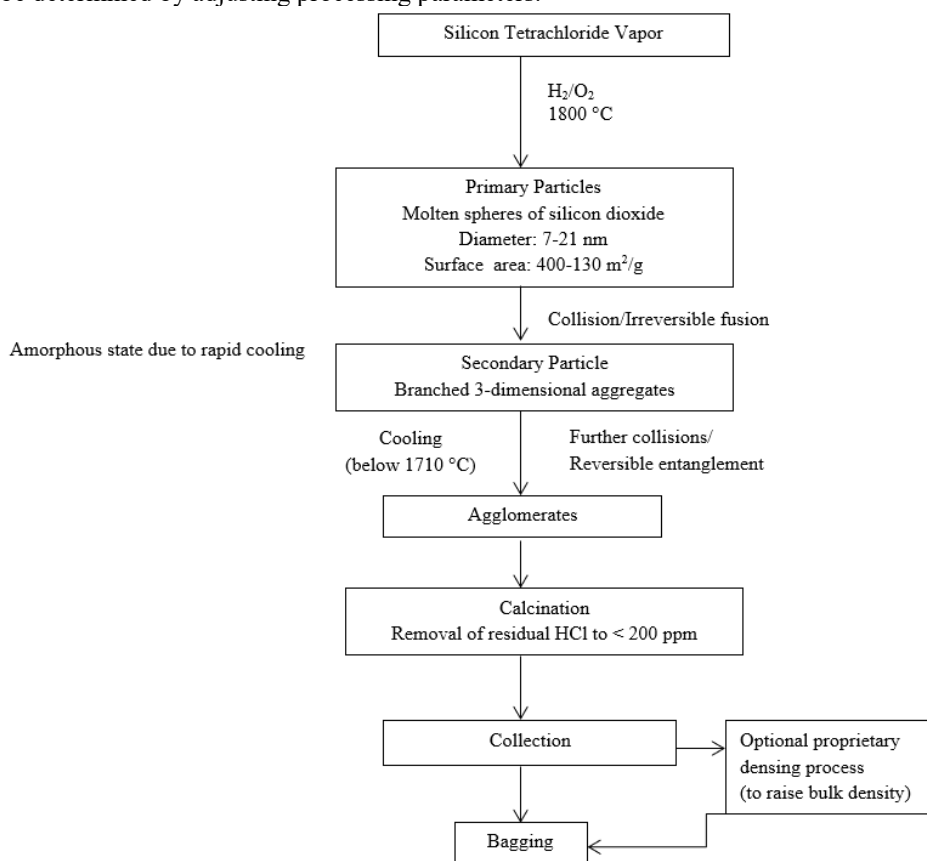

Figure 1. Process for the manufacture of Silica (pyrogenic form).

Silica may be produced by a vapor-phase process.⁸ The pyrogenic form of Silica is produced in a relatively anhydrous state. Hydrated Silica is produced by a wet process and contains a large amount of bound water.

Composition/Impurities

Silica

Silica has been reported to be > 95% to > 99.6% pure.^{2,11} Possible impurities include: sodium oxide (0.2% to 2.1% wt.), sulfur trioxide (0.2% to 3.0% wt.), iron (III) oxide (< 0.05% wt.), and other trace oxides (< 0.07% wt.). Heavy metal limits include: antimony (< 5 ppm), barium (< 50 ppm), chromium (< 10 ppm), arsenic (< 3 ppm), lead (< 10 ppm), mercury (< 1 ppm), cadmium (< 1 ppm), and selenium (< 1 ppm).

According to the *Food Chemicals Codex*, Silica (listed as silicon dioxide) may not contain more than 5 mg/kg lead.¹⁷

USE

Cosmetic

The safety of the cosmetic ingredients included in this assessment is evaluated based on data received from the US Food and Drug Administration (FDA) and the cosmetics industry on the expected use of these ingredients in cosmetics. Use frequencies of individual ingredients in cosmetics are collected from manufacturers and reported by cosmetic product category in the FDA Voluntary Cosmetic Registration Program (VCRP) database. Use concentration data are submitted by the cosmetics industry in response to surveys, conducted by the Personal Care Products Council (Council), of maximum reported use concentrations by product category.

According to 2019 VCRP data, Silica has a total of 8222 uses; the majority of the uses are in leave-on makeup preparations (e.g., eye makeup, lipsticks, foundations, and face powders; Table 3).¹⁸ Hydrated Silica has a total of 462 uses; the majority of the uses are in rinse-off oral hygiene and personal cleanliness products. The frequencies of use for Silica and Hydrated Silica have greatly increased since the original safety assessments were finalized; in 2009, Silica was reported to have 3276 uses and Hydrated Silica was reported to have 176 uses.⁵

The results of the concentration of use surveys conducted in 2018 by the Council indicate Silica is used at up to 82% in face and neck products and 50% in mascaras and lipsticks.¹⁹ Hydrated Silica is used at up to 33.8% in oral hygiene products and at up to 10% in leave-on skin care products. According to the original safety assessment, in 2008, the maximum use concentration reported for Silica was 44% in eye shadows,⁵ and the maximum use concentration reported for Hydrated Silica was 34% in dentifrices, with a maximum leave-on concentration of 4% in face powders.

Silica and Hydrated Silica may be used in products that can be incidentally ingested or come into contact with mucous membranes; for example, Silica is reported to be used in lipsticks at up to 50%, and Hydrated Silica is reported to be in dentifrices at up to 17.1%.¹⁹ Additionally, these ingredients have been reported to be used in products that may come into contact with the eyes, such as eye shadows, eye liners, and mascaras. Silica is reported to be used at up to 50% in mascaras, and Hydrated Silica at up to 5.8% in eyeliners.¹⁹ Moreover, these ingredients are reported to be used in spray products that could possibly be inhaled; for example, Silica is reported to be used at up to 2% in aerosol hair spray and at up to 0.84% in aerosol deodorants.¹⁹ Concerning final consumer product formulations (typically a mixture of ingredients), the Panel has noted that in practice, 95% to 99% of the droplets/particles released from cosmetic sprays have aerodynamic equivalent diameters > 10 µm, with propellant sprays yielding a greater fraction of droplets/particles below 10 µm compared with pump spray.²⁰⁻²³ Therefore, most droplets/particles incidentally inhaled from cosmetic sprays would be deposited in the nasopharyngeal and bronchial regions and would not be respirable (i.e., they would not enter the lungs) to any appreciable amount.^{20,22} There is some evidence indicating that deodorant spray products can release substantially larger fractions of particulates having aerodynamic equivalent diameters in the range considered to be respirable.²² However, the information is not sufficient to determine whether significantly greater lung exposures result from the use of deodorant sprays, compared to other cosmetic sprays. Ingredients in this report are also used in powders, and these products could possibly be inhaled. For example, Silica is reported to be used at up to 66% in face powders.¹⁹ Conservative estimates of inhalation exposures to respirable particles during the use of loose powder cosmetic products are 400-fold to 1000-fold less than protective regulatory and guidance limits for inert airborne respirable particles in the workplace.²⁴⁻²⁶

In regulations governing cosmetic products, Silica and Hydrated Silica are not restricted from use in any way in the European Union.²⁷

Non-Cosmetic

According to Australia's National Industrial Chemicals Notification and Assessment Scheme (NICNAS), Silica (as amorphous, fumed, crystalline-free; gel; gel-precipitated, crystalline-free; and vitreous) is a Tier I chemical (not considered to pose an unreasonable risk to the health of workers and public health).²⁸

Hydrated Silica

Hydrated Silica (colloidal) is used in fiber, sizing, diazo paper manufacture, cellophane film, ceramics, glass fiber, paints, batteries, foods, and polishing.²⁹

Silica

Silica is used in pharmaceuticals as a thickener in pastes and ointments to inhibit the separation of components and maintain flow properties in powder products.² It is also a general excipient for pharmaceuticals.^{30,31} Silica can function as a carrier for fragrances.² Silica is used in animal feed as carriers and anticaking agents in vitamins and mineral premixes. Silica is also used in paints, lacquers, plastics, paper, and in the production of “green tires”. Silica is used as an insecticide by cuticular lipid layer dehydration. Silica is used as reinforcing fillers for many non-staining and colored rubber and silicone products.^{2,13}

Silica has many uses in foods and food preparations.^{2,12,31} These include use as an anticaking agent in dry powders, a dispersion agent for dry powders in liquids, an anti-settling or suspending agent, a stabilizer in oil/water emulsions, a thickening or thixotropic agent, a gelling agent, a flavor carrier, an extrusion aid, a clarification and separation aid, and a support matrix for immobilization of enzymes. It is also used as a defoaming agent, conditioning agent, a chill-proofing agent in malt beverages, and a filter aid in foods.

TOXICOKINETICS

Absorption, Distribution, Metabolism, Excretion (ADME)

Animal

Oral

Silica

In an oral study of Silica (average particle size 15 μm) in an aqueous suspension, female rats (strain and number not specified) received 1500 mg/kg/d for 30 days via gavage.² Controls were not described. The rats were then killed and necropsied. The Silica content in the livers, kidneys, and spleen was 1.5 μg (control value = 1.8 μg), 6.4 μg (7.2 μg), and 5.3 μg (7.8 μg), respectively.

In a similar study, 20 female Sprague-Dawley rats received Silica (average particle size not reported) via gavage in an aqueous suspension (100 mg/rat; ~500 mg/kg) 20 times over one month.² Controls were not described. No clinical signs of toxicity were observed. The Silica content in the liver, spleen, and kidneys was 4.2 μg (control value = 1.8 μg), 5.5 μg (7.2 μg), and 14.2 μg (7.8 μg), respectively.

Silica and Hydrated Silica

In a dietary ADME study, 5 guinea pigs received Silica (0.8 mg/g feed) as three separate forms (sodium metasilicate, Hydrated Silica, and Silica solution (30%)) in single doses or in four repeated doses every 48 h.^{32,33} Urine and feces were collected in 48-h increments after each dose of each form and analyzed for Silica content. For the sodium metasilicate doses, the urinary output of Silica peaked within 48 h and gradually returned to normal after 8 days. When administered four times, 48 h apart, the peak was maintained, but did not increase. Within 48 h after the last dose, the concentration of Silica in the urine began to return to normal. With the Silica solution and Hydrated Silica, the urinary output of Silica also peaked within 48 h and gradually returned to normal after 8 days, but the peaks were much lower than those observed with sodium metasilicate. When administered four times, 48 h apart, the Silica concentrations behaved similarly to the sodium metasilicate form, except with a lower peak. In this study, approximately 63% of the Silica was recovered. The authors of the study suggested that the Silica in the urine was in the soluble or molybdate reactive form, and that the Silica particles underwent depolymerization prior to excretion.

Inhalation

Silica

The retention and elimination of aerosolized Silica (initial dose and particle size not reported) was studied in female inbred albino rats (strain and number not reported).² The rats were exposed to the test material 4 h/day, 5 days/week, for 40 days. The amount was then increased to 40 to 50 mg/m³ until day 120. Groups of rats were killed and necropsied periodically through the test period.

The average 1-day retention value was 28 $\mu\text{g}/\text{lung}$ at the lower unspecified concentration. During the first 10 days, a steep linear increase was seen with ~28 $\mu\text{g}/\text{day}$, as theoretically expected. Increments then became smaller. The author suggested that elimination increased and that an equilibrium between retention and elimination was established. After 40 exposures, the average 1-day retention value was 59 $\mu\text{g}/\text{lung}$ at the high concentration. After 120 exposures, the total deposit (lung and mediastinal lymph nodes) was 435 $\mu\text{g}/\text{lung}$, equivalent to 7.4% of the theoretically deposited material (5840 $\mu\text{g}/\text{lung}$, based on the measured 1-day retention); more than 92% of the deposited Silica in the alveoli was eliminated during the exposure period. At that time, the mean retention in the lungs was 300 $\mu\text{g}/\text{lung}$ (~69% of the total). The deposition rate in the mediastinal lymph nodes was negligible during the first 40 days, but increased gradually. After 120 exposures, the retention was substantial amounting to 135 μg (~31% of the total deposit). A test for the determination of free alveolar cells showed a decrease immediately after a single exposure and 24 h later an increase of 100% was observed.²

In another retention and elimination study, female Sprague-Dawley rats (number not reported) were exposed to aerosolized Silica (0.050 to 0.055 mg/l; particle size not provided) for 5 h/day for 5 days/week for one year.² Because the rats

had occurrences of bronchitis, putrid lung inflammation, and pronounced cell reactions, the exposure incidences were reduced to 2 or 3 days/week. Rats in each group were killed and necropsied periodically during treatment and after treatment.

After 6 weeks of treatment, Silica was observed in the lungs (0.5 mg) and the mediastinal lymph node (0.02 mg); after 18 weeks these values were 1.2 mg and 0.11 mg, respectively, and after 12 months, the values were 1.37 mg and 0.13 mg, respectively. Corresponding to the respiration volume, 1% of the inhaled Silica was retained in the lungs. After a recovery period of 5 months, there was 0.160 mg and 0.047 mg Silica observed in the lungs and mediastinal lymph node, respectively, with a reduction of 88% in the lung and > 50% in the lymph nodes. The increase in lung deposition was rapid at the initial exposure; amounts of deposited Silica were low from 18 weeks to 12 months of exposure.²

Groups of 10 male and 10 female Wistar rats were exposed to Silica (0, 0.51, 2.05, or 10.01 mg/m³; particle size not provided) for 6 h/day, 5 days/week, for 13 weeks.³ A group of rats from each dose group was allowed to recover for 13 weeks before being killed and necropsied. Silica was observed in the lungs in a concentration dependent manner at the end of exposure. Silica was observed in the tracheobronchial lymph nodes in the high dose group. After recovery, the amount of Silica in the lungs was below detection limits in the low dose group and only a small amount was detected in the high dose group.

Rats (strain and number not provided) were exposed to aerosolized Silica (hydrophilic; 50 to 55 mg/m³) for 12 months.³ Rats were killed and necropsied periodically and after 5 months recovery. There was 0.25 mg Silica in the lung at day 3, and 0.5 mg at 6 weeks. At 12 months, ~1% of the total administered respirable Silica was observed in the lungs. Initial accumulation was rapid and dropped off between week 18 and 12 months (0.5 mg at 6 weeks; 1.2 mg at 18 weeks; 1.37 mg at 12 months). The mediastinal lymph nodes contained ~0.02 mg Silica at 6 weeks and 0.13 at 12 months. After 5 months of recovery, the Silica in the lungs decreased to 0.16 mg/lung (88% reduction) and 0.047 mg/lymph node (> 50% reduction).

Rats (strain and number not provided) were exposed to aerosolized Silica (hydrophobic; 50 mg/m³; particle size not provided) for 5 h/day, 2 days/week, for 8 and 12 months.³ After 8 months, the lungs retained 1.448 mg Silica (1.3% of exposure) and after 12 months, 1.759 mg Silica (1.1%). The lymph nodes retained 0.05 and 0.113 mg, respectively. After a 12-month exposure and 1-month recovery, the lungs contained 1.1 mg Silica (37.5% elimination) and the lymph nodes contained 0.16 mg. After 3 months recovery, the lungs contained 0.43 mg and the lymph nodes 0.12 mg Silica. After 5 months recovery, the lungs contained 0.41 mg (76.7% elimination) and the lymph nodes 0.13 mg Silica.

Rats (strain and number not provided) were exposed to aerosolized Silica (hydrophobic; 100 mg/m³; particle size not provided) for up to 1 year.³ Silica content of the lungs and the lymph nodes was 4.33 and 0.132 mg at 3 months, 6.71 and 0.214 mg at 5 months, and 11.46 and 0.378 mg at 12 months, respectively. After 6 months of recovery, 55.5% of the Silica was eliminated from the lungs. Lymph node elimination could not be observed.

In an elimination study, aerosolized Silica (0.05 mg/l; particle size not provided) was administered for 5 h/day for 3 days to female Sprague-Dawley rats (number not specified).² The rats were observed for up to 3 months. Twenty hours after the last exposure, 0.25 mg Silica were found in the lungs. After 3 months, the Silica content was 0.018 mg. In the lymph node, 0.018 mg Silica was found after 1 month and 0.008 mg Silica after 3 months.

An elimination study was performed on rats (details not provided) exposed to aerosolized Silica (hydrophobic; 50 mg/m³; particle size not provided) for 1 or 3 days.³ The rats were killed and necropsied after 20 h, 1 month, or 3 months. At 1-month recovery, elimination of Silica was 78% (1 day exposure) and 75% (3 days exposure). After 3 months recovery, elimination was 87% and 92%, respectively. There was little Silica in the mediastinal lymph nodes.

Rats (details not provided) were exposed to aerosolized Silica (hydrophobic; 200 mg/m³; particle size not provided) in an elimination study for 5 h/d for 3 days.³ After a 3-month recovery period, 81% of the Silica was eliminated. Elimination by the lymph nodes was marginal.

Hydrated Silica

In an elimination study of Hydrated Silica (55 mg/m³; average particle size 15 µm), rats (details not provided) were exposed to the test material for 5 h.² The mean retention value at 20 h was 0.138 mg/lung. The mean Silica-content of the lungs for Hydrated Silica was 1.022 mg after 4 months recovery and 3.113 mg after 12 months recovery. The corresponding values for the mediastinal lymphatic nodes were 0.033 mg and 0.069 mg, respectively. Five months after exposure, the average value for the lungs was only 0.457 mg (87% elimination rate) and 0.052 mg for the mediastinal lymphatic nodes.

Subcutaneous

Silica

In a subcutaneous study in female Sprague-Dawley rats (number not provided), 6.90 mg Silica was measured in the tissue 24 h after a single dose of 10 mg was injected.^{2,3} One month after injection, the amount of Silica had decreased to 0.65 mg, and after 2 months, the amount of Silica at the injection site was 0.30 mg.

Approximately 95% to 97% of Silica (30, 40, or 50 mg in water) injected subcutaneously in rats was recovered 6 weeks after treatment (no further details).³

Human**Oral****Silica and Hydrated Silica**

Excretion of orally administered Silica and Hydrated Silica (as 1250 mg of Silica in apple juice) was evaluated in 2 groups of 6 volunteers (5 males and 1 female in each group).² The solutions were consumed in 2 doses, morning and midday, on the same day. The total urine was collected daily and analyzed. During the 4 days post-treatment, changes of renal Silica secretion were not observed. Daily Silica increments in urine after ingestion ranged between 7 and 23 mg. For Silica, the individual baseline values of the pre-test phase were very variable and individually different; mean excretion rates ranged from 25 to 87 mg/day. In the post-treatment phase, individual mean excretion rates ranged from 32 to 61 mg/day. For Hydrated Silica, the individual baseline values of the pre-test phase were very variable and individually different; mean excretion rates ranged from 16 to 71 mg/day. In the post-treatment phase, individual mean excretion rates ranged from 20 to 81 mg/day. Overall, increases in excretion were not unequivocally detectable. The authors noted that the small apparent increases were in marked contrast to the high dose of 2500 mg Silica ingested.

TOXICOLOGICAL STUDIES**Acute Toxicity Studies**

Acute dermal, oral, and inhalation data are summarized in Table 4. Hydrated Silica in water had a dermal LD₅₀ greater than 5 g/kg in rabbits.^{2,3} In oral rat studies, the LD₅₀s were > 2 g/kg for Silica (in polyethylene glycol 400).³ For Hydrated Silica at 12.1% in saline and 26% in water, oral LD₅₀s in rats were > 5 g/kg and 40 g/kg, respectively.^{2,3} In inhalation studies that ranged in duration from 1 to 6 hours, the LC₅₀s for Hydrated Silica (30% SiO₂) and Silica (concentration not reported) in rats were > 560 mg/m³ and > 139 mg/m³, respectively.^{2,3}

Short-Term, Subchronic, and Chronic Toxicity Studies**Animal**

Short-term, subchronic, and chronic toxicity studies for Hydrated Silica and Silica are summarized in Table 5.

No adverse effects were reported in a 3-week dermal study of Silica (up to 10 g/kg/day) in rabbits.³ In short-term oral studies, the no-observed-adverse-effect-level (NOAEL) for Hydrated Silica was ≥ 24.2 g/kg/day in a 14-day dietary study in rats.^{2,3} The no-observed-effect-level (NOEL) was 500 mg/kg/d in a 5- to 8-week dietary study in rats that were fed up to 16,000 mg/kg/day Silica.⁸ No treatment-related effects were observed in a 4 week dietary study of Silica (800 mg/kg/day) in rats or dogs.³⁴ In subchronic oral studies, the NOEL was 4000 mg/kg/day in a 13-week dietary study in rats fed Hydrated Silica at up to 4000 mg/kg/day.³ No clinical signs of toxicity or gross or microscopic changes were reported in a 13-week dietary study in rats that received up to 3500 mg/kg/day Silica.^{2,3} In oral chronic studies, lower liver weights in female rats, without significant findings at histopathological examinations, were observed in a 103-week dietary study of up to 5% Hydrated Silica in rats.³⁵ No remarkable findings were observed by the same researchers of the same material in a 93-week dietary study in mice.³⁵ The NOAEL in a 6-month dietary rat study of up to 10% Hydrated Silica was 8980 mg/kg/day.^{2,3} No remarkable findings were reported in 6-month dietary studies of up to 10% Silica in rats, although there were increased numbers of leukocytes and eosinophils in female and male rats, respectively, and reduced liver and prostate weights in another 6-month study at up to 3 g Silica/week.³⁶

In short-term inhalation studies with Hydrated Silica, inflammatory and pulmonary lesions were observed in rats at 30 mg/m³.^{7,37-42} Inflammatory responses were also observed in rats exposed to Silica in studies that lasted between 5 to 14 days.^{7,38,43} No significant lung histopathological findings or adverse changes in inflammatory markers were observed in rats that were exposed to nanoparticle Silica (particle size 50-79 nm; concentrations 0.4-5.4 mg/m³) for 4 weeks.⁴⁴ In subchronic inhalation studies, inflammatory responses were noted in the lungs and lymph nodes along with pulmonary lesions after exposure to Hydrated Silica at 35 mg/m³ (particle and agglomerate/aggregate size 1 to ~120 μm).⁴³ In a 13-week inhalation study of Silica in rats, the NOEL was 1.3 mg/m³.⁴³ Inflammation and pulmonary lesions, including fibrosis, were noted in this study and another 13-week rat study (fibrosis subsided during recovery).^{43,45} The lowest-observed-adverse-effect-concentration (LOAEC) in rabbits exposed for 9 months to Hydrated Silica was 28 mg/m³.⁴⁶ In inhalation studies of 9- to 12-month duration, Hydrated Silica caused pulmonary inflammation and emphysema in rats exposed to 25 to 85 mg/m³.⁴⁷ No silicotic processes were noted in studies of rabbits, rats, and guinea pigs exposed to an average of 126 mg/m³ Hydrated Silica for 12, 15, and 24 months, respectively; neoplasia was not observed.⁴⁸ In a 12-month study with Hydrated Silica and Silica in rats, the LOAEC was 6.9 mg/m³ due to interstitial fibrosis (which was comparable between test and control groups).⁴⁹ The same test materials also were associated with nodular fibrosis in an 18-month study with monkeys, although the animals may have been exposed to quartz or asbestos fibers. The LOAEC in a 6-month rat inhalation study with Silica was 53 mg/m³.⁴⁷ Emphysema and fibrosis were noted around 4 months of exposure. Inflammatory responses and pulmonary lesions were noted in rat, guinea pigs, rabbits, and monkeys in studies up to 24 months in duration.^{3,50-52} More than half the studies summarized in this report included recovery periods of various durations; results in recovery animals demonstrated that observed lung effects did not worsen, and in some cases began to resolve, after exposure ceased.

DEVELOPMENTAL AND REPRODUCTIVE TOXICITY (DART) STUDIES

Silica

In a DART study, pregnant female CD-1 mice were fed up to 1340 mg/kg Silica for 10 days (specific gestation days not provided).^{2,3} There were no effects on nidation or on maternal or fetal survival. Fetal abnormalities were similar to controls. The same results were reported for rats fed up to 1350 mg/kg for 10 days, hamsters fed up to 1600 mg/kg for 5 days, and rabbits fed up to 1600 mg/kg for 13 days.

In a subchronic dietary study that also investigated reproductive effects, Silica (500 mg/kg/day) was administered to female Wistar rats (n = 20) for 6 months.^{2,3,8} A control group of 20 female rats received just diet. The female rats were mated with male rats twice: at weeks 8 and 17. The male rats (number not reported) were also consuming 500 mg/kg/day of Silica. The rats were weighed periodically, blood sampled monthly (except during pregnancy), and observed daily. The progeny from both matings were examined for abnormalities. At 6 months, the rats were killed and necropsied, except for 5 rats which had a 3-week treatment-free period prior to being killed and necropsied.

Reproductive performance was similar between groups. Pathological examination revealed no differences between the groups. At the first mating, 6 control and 9 treatment dams became pregnant; 7 from each group became pregnant at the second mating. There were no treatment-related effects in litter size, birth weight, physical parameters, or behavior. Development of progeny during lactation was without adverse effects; weight gains were normal. No treatment related effects were found during gross pathology. The authors conclude that the oral NOEL was > 500 mg/kg for developmental and reproductive toxicity.^{2,3,8}

GENOTOXICITY STUDIES

Genotoxicity data are summarized in Table 6. Hydrated Silica and Silica were not genotoxic in Ames tests, hypoxanthine-guanine phosphoribosyl transferase (HGPRT) gene mutation assays, or chromosome aberration tests.^{2,3,8,53-56} Chromosome aberration (oral dosing), dominant lethal mutation (oral dosing), gene mutation (intraperitoneal (i.p.) injection), and mitotic recombination (i.p. injection) studies of Hydrated Silica at up to 5000 mg/kg in mice and rats were negative.^{3,57}

CARCINOGENICITY STUDIES

Silica

The International Agency for Research on Cancer (IARC) concluded that amorphous Silica is not classifiable as to its carcinogenicity to humans based on inadequate evidence in humans and inadequate evidence of increased tumors in animals.⁵⁸

Oral

Hydrated Silica

In a carcinogenicity study, groups of 10 male and 10 female B₆C₃F₁ mice received Hydrated Silica (0%, 1.25%, 2.5%, or 5%) in their feed for 93 weeks.³⁵ In the female mice, the frequencies of adenocarcinoma in the lungs were 1/16 (6.25%) for the control group and 1/19 (5.3%), 0/20 (0%), and 1/20 (5%) for the low, mid and high dose groups. In the males, the frequencies of adenocarcinoma in the lungs were 1/16 (6.25%) for the control and 2/17 (11.8%), 3/14 (21.4%), and 3/16 (18.8%) for the low, mid, and high dose groups. There was low correlation of hyperplastic nodules/hepatocellular carcinoma/hemangioma/fibrosarcoma in the treatment groups compared to the controls. The researchers concluded that the non-neoplastic lesions were of no toxicological significance.

Silica

In a 2-year dietary study, Wistar rats (n = 40; 20 males and 20 females) received 100 mg/kg Silica (pyrogenic) in their feed.⁸ The rats were weighed before and after treatment. At the end of the treatment period, the rats were killed and necropsied. There were no clinical signs of toxicity observed during the treatment period. The rates of tumors observed in the treated rats were comparable to historical controls. The researchers concluded that there were no carcinogenic effects from the daily ingestion of Silica in this study.

Inhalation

Hydrated Silica

The potential carcinogenic effects of aerosolized Hydrated Silica ($\leq 5 \mu\text{g}$ particle size) was studied in tumor-susceptible mice (n = 75) starting at 3 months of age.⁵⁹ The mice received 0.5 g/day Hydrated Silica in a 600 L capacity respiratory chamber once/h, 6 h/day for 5 days/week for a year. The mice were allowed to live out their natural life span for up to 917 days from the start of the experiment. The incidence of primary lung tumors was 7.9% in the control group and 21.3% in the treated group in mice that lived 10 months or longer. There was no obvious fibrosis in the lung tissue; however, there were fibrotic nodules in the trachea-bronchial lymph nodes in > 50% of the mice. The researchers suggested that most of the Silica dust was removed by cilia action through the trachea and also through the lymphatic system. Half of the treated mice had overgrowth of the mediastinal connective tissue covering the trachea-bronchial nodes which occurred in only 10% of the controls. In the treated group, 29.5% had an increase in incidence of overgrowth or hyperplasia of the trachea-bronchial lymph nodes compared to 14.3% of the controls.

Intratracheal

Silica

The carcinogenic potential of Silica (3 mg in 0.9% phosphate-buffered saline; 0.01 to 0.03 μm) was studied in 40 female SPF Wistar rats.⁶⁰ The rats received the test material intratracheally 5 times weekly and were observed until death or month 30, at which time they were killed and necropsied. A second group of 40 rats had Silica instilled at the same dose 10 times weekly. Controls (n = 48) were untreated. The survival rates were 37/40 for group 1, 35/40 for group 2, and 46/48 for the controls. The period of time after the first treatment in which 50% of the rats died was 113 and 112 weeks in the first and second groups, respectively, and 113 weeks in the control group. The percentage of rats with macroscopic lung tumors was 13.5% in the first group, 2.9% in the second group, and 6.5% in the control group. The percentage of rats with macroscopic lung tumors which are probably not a metastasis of other tumors located elsewhere was 8.1% in the first group, none in the second group, and none in the control group. The percentage of rats with benign lung tumors in the second group was 5.7% and there were none in the control group; this was not analyzed in the first experiment. Neither the second group nor the control group had malignant tumors. The percentage of rats with lung tumors that were metastases of other primary site tumors was 14.3% in the treatment groups and 13.0% in the control group.

OTHER RELEVANT STUDIES

Immune Response

Human

Hydrated Silica

Hydrated Silica (1 to 4 mg in saline; $\sim 15 \mu\text{m}$ particle size) was injected subcutaneously 2 to 8 times in 28 volunteers.⁶¹ Biopsies were taken from day 1 to 6 months. Granulomatous inflammation was observed within 7 days and persisted for months. The researchers suggested that this was a particular type of foreign body response to a fibrogenic agent and not typical epithelioid cell nodules.

DERMAL IRRITATION AND SENSITIZATION STUDIES

Dermal irritation and sensitization data summarized below are detailed in Table 7. Very slight to no irritation was observed in dermal irritation studies in rabbits with Hydrated Silica (at up to 50% solution in olive oil) and Silica (up to 12% solution in methyl ethyl cellulose).^{2,3} Hydrated Silica (20%) was not sensitizing in guinea pig sensitization tests.⁶² Hydrated Silica (up to 45%) and Silica (21.74% in formulation) were not sensitizing in human repeat insult patch tests (HRIPTs).^{2,36,63,64}

OCULAR IRRITATION STUDIES

In vitro and animal ocular irritation data are summarized in Table 8. Hydrated Silica (concentration not provided) and Silica were both not irritating to slightly irritating in rabbit eyes.^{3,8,36,65}

CLINICAL STUDIES

Occupational Exposure

Hydrated Silica

In an occupational study, 78 workers (aged 21 to 67 years; average 34.23 years) were examined who had been exposed to precipitated Silica from 1941 to 1959.⁶⁶ Dust concentrations ranged from 0.35 to 204 mg/m^3 . There was no evidence of silicosis or other pulmonary disease.

Workers (n = 165) exposed to Hydrated Silica for a mean of 8.6 years were examined for adverse effects.⁶⁷ Dust levels varied from < 1 to 10 mg/m^3 , with some higher intermittent levels. Examination included spirometers, respiratory questionnaires, and chest radiographs. Cough and dyspnea correlated with level/time of smoking and not Silica exposure. There were no correlations between yearly change of pulmonary function and dose or time of exposure. The workers with the mean exposure time of 18 years had pulmonary function similar to the rest of the group. There was radiographic evidence of minimal pneumoconiosis that was biased due to prior exposure to limestone. None of the 143 workers with exposure only to Silica showed radiographic evidence of pneumoconiosis.

Another study examined 41 workers exposed to Hydrated Silica and compared them to a control group.⁶⁸ The examination included blood gas analysis and chest radiographs. There was a reduction in forced expiratory flow in the exposed group. There was no correlation between the exposure index and pulmonary function. The authors concluded that smoking and exposure to Silica synergize to induce small airway disease.

In another unpublished occupational study of workers in Hydrated Silica factories (1952 to 1981), there was no silicosis in workers employed for 1 to > 20 years (mean 13.2 years).² There were negative results in hematology, urine analysis, lung functions, and chest x-rays.

In an unpublished study, 150 workers in a Hydrated Silica factory were examined by pulmonary function test and x-ray.³ The workers were exposed for ≥ 6 h/day for at least 5 continuous or discontinuous years. The mean duration was 12.2 years. The control group had been exposed for a maximum of 3 continuous or discontinuous months. The mean ages for the

experimental and control groups were 43.1 and 44.3 years, respectively. There were no differences in the distributions and types of dysfunctional measurements observed between exposed and non-exposed groups. There were no differences in the mean percentage of predicted pulmonary function values between exposed and non-exposed groups. None of the x-rays showed signs of pneumoconiosis or fibrosis.

Silica

The Occupational Safety and Health Administration (OSHA) permissible exposure limit (PEL) to amorphous Silica is 80 mg/m³ or 20 million particles per cubic foot air averaged over an 8-h work shift.¹⁰ The National Institute for Occupational Safety and Health recommended exposure limit (REL) for amorphous Silica is 6 mg/m³.

Workers (n = 215) with exposure to Silica between 1947 and 1959 were studied using chest x-rays.⁶⁹ Exposure ranged from 15 to 100 mg/m³, 2 to 6 mg/m³, and 3 to 7 mg/m³, depending on workstation. Hairline actuation of the interlobar fissures, suggesting slight interlobar pleuritis, was the only remarkable sign. There were no signs of silicosis.

In an unpublished study, 29 workers in a silicone products manufacturing plant were surveyed.³ Silica exposure ranged from 0.15 to 10 mg/m³, with a mean of 1.7 mg/m³. Ten of 15 workers in the room temperature vulcanizing rubber area complained of upper respiratory tract irritation. Some of the workers in the heat curable rubber compounding area, where the potential exposure to Silica was greater, complained about eye irritation, nausea, headaches, or rashes; none reported upper or lower respiratory problems.

Workers (n = 200) with intensive and regular contact with Silica from 1972 to 2000 were evaluated.² There was no evidence of skin allergy caused by the Silica. There were signs of irritation attributed to the desiccative and defatting properties of Silica, which resulted in skin dryness; this effect could be controlled by regular use of skin-protection ointment.

An occupational study of 143 workers exposed to Silica from 1959 to 1985 was performed.² Exposure ranged from 1 to 34 years. There were complaints of abnormalities in lung function or histology in 54/143 (36%) of the workers (no further details available). Dry cough, expectoration or dyspnea was reported in 34/54 of these workers. A total of 42/54 (78%) of these workers had some possible confounding factor (i.e., smoking). Radiological examination did not show any signs of fibrotic disease. Spirometry showed obstructive and/or restrictive ventilation disturbances in 24 workers. Most of the adverse findings were associated with the confounding factors.

In an unpublished occupational exposure study, x-rays were taken of 99 workers who had manufactured Silica for various amounts of time.² The x-rays revealed no evidence of any occupational disease, including silicosis.

SUMMARY

This report assesses the safety of synthetically-manufactured amorphous Silica and Hydrated Silica as used in cosmetics. These ingredients are both reported to function as abrasives, absorbents, anticaking agents, bulking agents, and opacifying agents in cosmetic products. The Panel considered the method of manufacture of these ingredients (synthetic and not mined) to be of significant importance when reviewing safety. Thus, the current assessment is exclusive to amorphous Silica and Hydrated Silica when manufactured via synthetic methods.

According to 2019 VCRP data, Silica has a total of 8222 uses; the majority of the uses are in leave-on makeup preparations and eye makeup preparations. Hydrated Silica has a total of 462 uses; the majority of the uses are in rinse-off oral hygiene and personal cleanliness products. The uses for both of these ingredients have increased since the original safety assessments were finalized: in 2009, Silica was reported to have 3276 uses and Hydrated Silica was reported to have 176 uses. The results of the concentration of use survey conducted in 2018 by the Council indicate Silica is used at up to 82% in face and neck products and 50% in mascaras. Hydrated Silica is used at up to 33.8% in oral hygiene products and at up to 10% in leave-on skin care products. According to the original safety assessment, the maximum use concentration in 2008 for Silica was 44% in eye shadows. The maximum use concentration for Hydrated Silica in 2008 was 34% in dentifrices; the maximum leave-on concentration was 4% in face powders.

Hydrated Silica in water had a dermal LD₅₀ greater than 5 g/kg in rabbits. In oral rat studies, LD₅₀s of 40 g/kg Hydrated Silica (26% in water) and > 10 g/kg Silica (in stock diet 1:4 w/w) were reported. In inhalation studies that ranged in duration from 1 to 6 hours, the LC₅₀s for Hydrated Silica (30% SiO₂) and Silica (concentration not reported) in rats were > 3300 mg/m³ and > 191,300 mg/m³, respectively.

No adverse effects were reported in a 3-week dermal study of Silica (up to 10 g/kg/d) in rabbits. In short-term oral studies, the NOAEL for Hydrated Silica was > 24.2 g/kg/day in a 14-day dietary study in rats. The NOEL was 500 mg/kg/d in a 5- to 8-week dietary study in rats that were fed up to 16,000 mg/kg/d Silica. In subchronic oral studies, the NOEL was 4000 mg/kg/day in a 13-week dietary study in rats fed Hydrated Silica at up to 4000 mg/kg/d. No clinical signs of toxicity or gross or microscopic changes were reported in a 13-week dietary study in rats that received up to 3500 mg/kg/d Silica. In oral chronic studies, lower liver weights in female rats without significant findings at histopathological examinations was observed in a 103-week dietary study of up to 5% Hydrated Silica in rats, but no remarkable findings were observed by the same researchers of the same material in a 93-week dietary study in mice. The NOAEL in a 6-month dietary rat study of up to 10% Hydrated Silica was 8980 mg/kg/d. No remarkable findings were reported in 6-month dietary studies of up to 10% Silica in rats, although there were reduced liver and prostate weights and increased numbers of leukocytes and eosinophils in female and male rats, respectively, in another 6-month study at up to 3 g Silica/week.

In short-term inhalation studies with Hydrated Silica, inflammatory and pulmonary lesions were observed in rats at 30 mg/m³. Inflammatory responses were also observed in rats exposed to Silica in studies that lasted between 5 to 14 days. No significant lung histopathological findings or adverse changes in inflammatory markers were observed in rats that were exposed to nanoparticle Silica (particle size 50 - 79 nm; concentrations 0.4 - 5.4 mg/m³) for 4 weeks. In subchronic inhalation studies, inflammatory responses were noted in the lungs and lymph nodes along with pulmonary lesions after exposure to Hydrated Silica at 35 mg/m³ (particle and agglomerate/aggregate size 1 to ~120 µm). In a 13-week inhalation study of Silica in rats, the NOEL was 1.3 mg/m³. Inflammation and pulmonary lesions, including fibrosis, were noted in this study and another 13-week rat study (fibrosis subsided during recovery). In inhalation studies of 9- to 12-month duration, Hydrated Silica caused pulmonary inflammation and emphysema in rats exposed to 25 to 85 mg/m³. The LOAEC in rabbits exposed for 9 months to Hydrated Silica was 28 mg/m³. No silicotic processes were noted in studies of rabbits, rats, and guinea pigs exposed to an average of 126 mg/m³ Hydrated Silica for 12, 15, and 24 months, respectively. No neoplasia was observed. In a 12-month study with Hydrated Silica and Silica in rats, the LOAEC was 6.9 mg/m³ due to interstitial fibrosis (which was comparable between test and control groups). The same test materials also were associated with nodular fibrosis in an 18-month study with monkeys, although the animals may have been exposed to quartz or asbestos fibers. The LOAEC in a 6-month rat inhalation study with Silica was 53 mg/m³. Emphysema and fibrosis were noted around 4 months of exposure. Inflammatory responses and pulmonary lesions were noted in rat, guinea pigs, rabbits, and monkeys in studies up to 24 months in duration. More than half of the studies summarized in this report included recovery periods of various durations that showed that observed lung effects began to resolve or did not worsen after exposure ceased.

Hydrated Silica and Silica were not genotoxic in Ames tests, HGPRT gene mutation assays, or chromosome aberration tests. Genotoxicity studies of Hydrated Silica at up to 5000 mg/kg in mice and rats were negative.

Carcinogenic effects were not reported in oral studies of Hydrated Silica (0%, 1.25%, 2.5%, or 5%) in mice or Silica (100 mg/kg) in rats. An inhalation study of Hydrated Silica (≤ 5 µg particle size; 0.5 g/day) in mice and an intratracheal study of Silica (3 mg in 0.9% phosphate-buffered saline; 0.01 to 0.03 µm) in rats also were negative for carcinogenicity.

Very slight to no irritation was observed dermal irritation studies in rabbits with Hydrated Silica (at up to 50% solution in olive oil) and Silica (up to 12% solution in methyl ethyl cellulose). Hydrated Silica (20%) was not sensitizing in guinea pig sensitization tests. Hydrated Silica (up to 45%) and Silica (21.74% in formulation) were not sensitizing in HRIPT. Hydrated Silica (concentration not provided) and Silica were not irritating to slight irritating in rabbit eyes.

Workers in environments with aerosolized Silica had few signs of silicosis or pulmonary disease up to 100 mg/m³. Smoking and exposure to Silica synergize to induce small airway disease. Exposure to Hydrated Silica also had no evidence of silicosis or pulmonary disease. There were signs of dermal irritation due to the desiccative and defatting properties of Silica.

DISCUSSION

The Panel assessed the safety of synthetically-manufactured amorphous Silica and Hydrated Silica, and considered the method of manufacture of these ingredients (synthetic and not mined) to be of significant importance when reviewing safety. The Panel emphasized that this report reviews only the safety of synthetically-manufactured amorphous Silica and Hydrated Silica. Crystalline silica, and synthetic and mined silicates are not toxicologically similar to synthetically-manufactured amorphous Silica and Hydrated Silica, and thus require separate reviews.

Data were sufficient to assess the safety of synthetically-manufactured amorphous Silica and Hydrated Silica, and the Panel determined that these two ingredients do not pose an incidental inhalation safety risk, under conditions of cosmetic use. The exposures that were tested in inhalation studies were at much higher concentrations than those possible with cosmetic use, and had very few adverse effects. Aggregation and agglomeration of Silica and Hydrated Silica particles in cosmetic formulations reduces potential inhalation exposure. While the Panel noted the effects on trachea-bronchial lymph nodes in mice, the carcinogenicity study used such high concentrations of Hydrated Silica that the effects were due to the overload of the animal system; therefore, concern over incidental inhalation of Silica in cosmetics was mitigated.

The Panel was concerned, however, that the potential exists for dermal and ocular irritation with the use of products formulated using Silica and Hydrated Silica. Therefore, the Panel specified that products containing these ingredients must be formulated to be non-irritating.

CONCLUSION

The Panel concluded that synthetically-manufactured amorphous Silica and Hydrated Silica are safe in the present practices of use and concentration described in the safety assessment when formulated to be non-irritating.

TABLES**Table 1.** Definitions and functions.¹

Ingredient & CAS No.	Definition	Function(s)
Hydrated Silica 10279-57-9 112926-00-8 1343-98-2 (silicic acid) 63231-67-4 7631-86-9	Hydrated Silica is the inorganic oxide that conforms generally to the formula $\text{SiO}_2 \cdot x\text{H}_2\text{O}$.	Abrasives; Absorbents; Anticaking Agents; Bulking Agents; Opacifying Agents; Oral Care Agents; Skin-Conditioning Agents – Misc.; Viscosity Increasing Agents - Aqueous
Silica 112945-52-5 60676-86-0 7631-86-9	Silica is the inorganic oxide that conforms to the formula SiO_2 .	Abrasives; Absorbents; Anticaking Agents; Bulking Agents; Dispersing Agents – Nonsurfactant; Opacifying Agents

Table 2. Physical and chemical properties of Silica

Property	Value	Reference
Physical Form	White fluffy powder	8
Formula Weight (Da)	60.1	9
Density (g/ml @ 20°C)	2.2	2
Specific Gravity (g/ml)	2.65	10
Vapor Pressure (mmHg)	0	9,10
Melting Point (°C)	~1700-1710	2,9,10
Boiling Point (°C)	2230	9
Water Solubility (mg/l @ 20°C)	15-68	2
pH	4-9	2

Table 3. Current and historical frequency and concentration according to duration and type of exposure for synthetically-manufactured Silica and Hydrated Silica.^{5,18,19}

	Hydrated Silica				Silica**			
	# of Uses		Max Conc of Use (%)		# of Uses		Max Conc of Use (%)	
	2019*	2009	2018	2008	2019	2009	2018	2008
Totals*	462	176	0.00001-33.8	0.001-34	8222	3276	0.000005-82	0.0000003-44
Leave-On	171	90	0.0002-10	0.001-4	7499	2937	0.0001-82	0.00004-44
Rinse-Off	283	78	0.00001-33.8	0.01-34	669	316	0.000005-21	0.0000003-16
Diluted for (Bath) Use	8	8	0.3-12	0.4-4	54	23	0.1-4	0.02-2
Eye Area	9	8	0.001-5.8	0.06-2	2348	867	0.00068-50	0.0004-44
Incidental Ingestion	81	25	0.17-33.8	0.003-34	1565	551	0.014-50	0.01-21
Incidental Inhalation-Spray	16 ^a ; 10 ^b	10 ^a ; 12 ^b	0.45-0.9; 8.9-23.7 ^a	0.04-2 ^a ; 0.06-2 ^b	166; 516 ^a ; 419 ^b	19; 247 ^a ; 183 ^b	0.0001-2; 0.0042-14 ^a ; 0.5-1 ^b	0.0005-6; 0.00004-8 ^a ; 0.02-10 ^b
Incidental Inhalation-Powder	33; 10 ^b	33; 12 ^b	1; 0.0012-10 ^c	2-4; 0.06-2 ^b	520; 419 ^b ; 3 ^c	248; 183 ^b ; 1 ^c	0.016-66; 0.5-1 ^b ; 0.08-82 ^c	1-26; 0.02-10 ^b
Dermal Contact	349	117	0.0002-16	0.001-17	5416	2298	0.0001-82	0.0000003-44
Deodorant (underarm)	1 ^a	NR	0.066	2 ^a	31 ^a	38 ^a	0.0001-10.4 ^d	0.02-9 ^a
Hair - Non-Coloring	4	NR	0.00001-8.9	0.04-2	142	51	0.000005-4	0.0005-3
Hair-Coloring	10	20	1.9-8.9	2	233	149	0.0005-10	0.002-6
Nail	15	13	0.75-5.5	1-2	559	92	0.2-10	0.3-9
Mucous Membrane	250	50	0.0051-33.8	0.003-34	1834	624	0.0005-50	0.0000003-21
Baby Products	NR	NR	0.0041-0.005	NR	7	2	0.0006-3	0.003-10

NR = Not reported.

† Because each ingredient may be used in cosmetics with multiple exposure types, the sum of all exposure types may not equal the sum of total uses.

^a. It is possible these products may be sprays, but it is not specified whether the reported uses are sprays.^b. Not specified whether a powder or a spray, so this information is captured for both categories of incidental inhalation.^c. It is possible these products may be powders, but it is not specified whether the reported uses are powders.^d. Concentration of use in aerosol deodorants reported to be 0.0001% - 0.084%.

*Includes entries for Hydrated Silica and Silicic Acid from the VCRP database.

** Includes entries for Silica; Silica, Amorphous; Silica, Fumed; and Silicon Dioxide, Colloidal from the VCRP database.

Table 4. Acute toxicity studies

Ingredient/Concentration/Vehicle	Dose/Study Protocol	Results	LD ₅₀ or LC ₅₀	Reference
<i>Dermal</i>				
Hydrated Silica; no further details	2000 mg/kg bw applied to intact and abraded skin for 24 h; 10 New Zealand white rabbits; no further details	Details not provided	> 2000 mg/kg	2,3
Hydrated Silica; in water	2000, 3000, 4000, or 5000 mg/kg in groups of 4 New Zealand white rabbits; 2 rabbits in each group had abraded skin; test site was covered with occlusive patch for 24 h; no further details	Very slight erythema; no systemic signs of toxicity or organ toxicity	> 5000 mg/kg	2,3
<i>Oral</i>				
Hydrated Silica; suspended (12.1% (w/v)) in 0.85% saline	Male rats; no further details	No clinical signs of toxicity; no treatment-related effects at necropsy	> 5000 mg/kg	2,3
Hydrated Silica; 26% in water; pH 4.5	10 male Sprague-Dawley rats; no further details	Details not provided	40,000 mg/kg bw	2,3
Hydrated Silica; suspended in water (33% w/w)	10,000, 12,600, 15,800, or 20,000 mg/kg bw; 5 Sprague-Dawley rats per sex per dose via gavage	No clinical signs of toxicity; stools were white for 2 days	> 20,000 mg/kg bw	2,3
Hydrated Silica; in water	5620 mg/kg; 30 male Sprague-Dawley rats via single gavage dose	No clinical signs of toxicity; stools were white for 2 days	> 5620 mg/kg bw	2,3
Hydrated Silica; in water	10,000 mg/kg bw; 5 male and 5 female Sprague-Dawley rats; no further details	Details not provided	> 10,000 mg/kg bw	3
Hydrated Silica; in water	31,600 mg/kg bw; 5 male and 5 female Sprague-Dawley rats; 24 h observation; no further details	Details not provided	> 31,600 mg/kg bw	3
Hydrated Silica; in 0.85% saline	10 to 5000 mg/kg bw; male rats; no further details	Distended stomachs with bloody patches at the pyloric end were observed at necropsy in animals that received > 100 mg/kg; at 5000 mg/kg, vascular stomach and reddened intestinal lining were observed	470 mg/kg	2,3
Hydrated Silica; in saline	5000 mg/kg bw; male Sprague-Dawley rats; no further details	Details not provided	>5000 mg/kg bw	3
Hydrated Silica; average particle size 100 µm; in aqueous suspension of 1% carboxymethylcellulose	2000 or 5000 mg/kg bw; 10 male and 10 female Sprague-Dawley rats per single dose via gavage	No clinical signs of toxicity; no treatment-related effects at necropsy	> 5000 mg/kg	2,3
Hydrated Silica; average particle size 8 µm; in carboxymethylcellulose	5110 mg/kg; 5 male and 5 female Wistar rats via gavage	No clinical signs of toxicity; no treatment-related effects at necropsy	> 5110 mg/kg	2,3
Hydrated Silica; in olive oil	4000, 5040, or 6350 mg/kg bw; 5 male and 5 female Sprague-Dawley rats per dose group; no further details	Details not provided	> 6350 mg/kg bw	3
Hydrated Silica; in olive oil	5040, 6350, or 7900 mg/kg bw; 5 male and 5 female Sprague-Dawley rats per dose group; no further details	Details not provided	> 7900 mg/kg bw	3
Hydrated Silica; in 1% aqueous gum arabic solution	20,000, 25,200, or 31,800 mg/kg bw; 5 male and 5 female Sprague-Dawley rats per dose group; no further details	Details not provided	> 31,800 mg/kg bw	3
Hydrated Silica; in dispersion of 10% gum arabic in water	5000 mg/kg; 5 male and 5 female rats; no further details	No clinical signs of toxicity; no treatment-related effects at necropsy	> 5000 mg/kg	2,3
Hydrated Silica; 30% neutralized with HCl	Male rats; no further details	Details not provided	10,000 mg/kg bw	2,3
Silica (hydrophilic); in corn oil	178, 316, 562, 1000, 1780, or 3160 mg/kg bw; groups of 10 male Swiss mice; via gavage	No adverse signs of toxicity and no macroscopic lesions at necropsy	> 3160 mg/kg bw	2,3
Silica; no further details	1000, 2150, or 3160 mg/kg bw in 5 male albino rats; no further details	No gross signs of systemic toxicity and no mortalities	> 3160 mg/kg bw	65
Silica; no further details	30 male rats; no further details	No clinical signs of toxicity or mortalities during the 2-week observation period	> 5620 mg/kg bw	36
Silica; incorporated into a stock diet at a ratio of 1:4 (w/w)	10 Wistar male/female rats; dosing period was 24 h; no further details	No clinical signs of toxicity; no treatment-related effects at necropsy; stool grey in color with normal consistency but larger in size than normal	> 10,000 mg/kg	2,3
Silica (hydrophilic); in water	5 male and 5 female Sprague-Dawley rats; no further details	Details not provided	> 5000 mg/kg bw	3

Table 4. Acute toxicity studies

Ingredient/Concentration/Vehicle	Dose/Study Protocol	Results	LD₅₀ or LC₅₀	Reference
Silica (hydrophobic); in distilled water	1000, 1590, 2510, 3980, 6310, or 10,000 mg/kg bw; groups of 5 male and 5 female Sprague-Dawley rats; no further details	Details not provided	9200 mg/kg bw males >10,000 mg/kg bw females	³
Silica (hydrophobic); in corn oil	178, 316, 562, 1000, 1780, or 3160 mg/kg bw; groups of 10 male Sprague Dawley rats; no further details	Details not provided	> 3160 mg/kg bw	³
Silica (hydrophobic); in corn oil	5000 mg/kg bw; 5 male and 5 female Sprague-Dawley rats; no further details	Details not provided	> 5000 mg/kg bw	³
Silica (hydrophobic); in peanut oil	2500 or 5000 mg/kg bw; 10 male and 10 female Sprague-Dawley rats; no further details	Details not provided	> 5000 mg/kg	³
Silica; in olive oil	5040, 6350, or 7900 mg/kg in olive oil or 2500 or 5000 mg/kg in peanut oil	No clinical signs of toxicity or unscheduled mortalities during the 4-week observation period; no treatment-related effects at necropsy	> 7900 mg/kg in olive oil	⁸
Silica; in aqueous suspension of 1% methylhydroxyethyl cellulose	2000 or 3300 mg/kg bw in 10 male and 10 female Sprague-Dawley rats per single dose via gavage	No clinical signs or gross macroscopic signs of toxicity observed	> 3300 mg/kg	^{2,3}
Silica (hydrophilic); in 0.5% methylcellulose	1000, 2750, or 3160 mg/kg bw; 5 male Boltzman rats per dose group; no further details	Details not provided	> 3160 mg/kg	³
Silica (hydrophobic); in polyethylene glycol 400	2000 mg/kg bw; 5 male and 5 female Wistar rats; no further details	Details not provided	> 2000 mg/kg bw	³
Inhalation				
Hydrated Silica (5% SiO ₂); as mist; no further details	760 mg/m ³ ; male albino rats; 3.25 h whole body exposure; no further details	No deaths; no further details	> 760 mg/m ³	³
Hydrated Silica (20% SiO ₂); as mist; no further details	2240 or 2500 mg/m ³ ; male albino rats; 4.2 h whole body exposure; no further details	No deaths; no further details	> 2500 mg/m ³	³
Hydrated Silica (30% SiO ₂); as mist; no further details	520 or 560 mg/m ³ ; 2 male rats; 2.5 or 6 h nose-only exposure; preliminary test; no further details	No deaths; no further details	> 560 mg/m ³	³
Hydrated Silica (30% SiO ₂); as mist; no further details	3300 mg/m ³ ; male albino rats; 1.5 h whole body exposure; no further details	No deaths; no further details	> 3300 mg/m ³	³
Hydrated Silica; 45% of particles < 5 µm; surface area (SA) = 190	691 mg/m ³ ; 5 male and 5 female Wistar rats; 4 h whole body exposure; no further details	Some decreased body weight gain in females 2 days post-exposure which resolved by day 14; no abnormalities observed at necropsy	> 691 mg/m ³	^{2,3}
Hydrated Silica; no further details	2200 mg/m ³ ; 10 male Sprague-Dawley rats; 1 h nose-only exposure; no further details	One rat died 2 h after exposure; irritation and dyspnea observed in most animals; no further details	> 2200 mg/m ³	^{2,3}
Hydrated Silica; no further details	3100 mg/m ³ ; 2 male rats; 4 h nose-only exposure; no further details	Details not provided	> 3100 mg/m ³	³
Silica (hydrophobic); no further details	250 mg/m ³ ; groups of 10 male Swiss mice; 6 h whole body exposure; no further details	Clinical signs of toxicity included preening and occasional prostration; no significant findings at necropsy	> 250 mg/m ³	³
Silica (hydrophobic); particle size < 0.1 µm; SA = 300 m ² /g	90, 350, or 5000 mg/m ³ ; groups of 5 male and 5 females Sprague-Dawley rats; 4 h whole body exposure; no further details	Details not provided	90 mg/m ³	³
Silica (hydrophobic); particle size = 0.15 µm; SA = 130 m ² /g	2280 mg/m ³ ; 5 male and 5 female rats; 1 h whole body exposure; no further details	Details not provided	> 2280 mg/m ³	³
Silica (hydrophobic); particle size < 0.2 µm; SA = 130 m ² /g	350, 770, 2530, or 5300 mg/m ³ ; groups of 5 male and 5 females Sprague-Dawley rats; 4 h whole body exposure; no further details	All rats in 2530 and 5300 mg/m ³ dose groups died; severe red discoloration of the lungs was noted in the rats that died during the study; no further details	1650 mg/m ³	³
Silica (hydrophobic); particle size = 0.36 µm; SA = 200 m ² /g	0 or 4900 mg/m ³ ; groups of 5 male and 5 female Sprague-Dawley rats; 4 h whole body exposure; no further details	All animals of the test group died	< 4900 mg/m ³	³
Silica (hydrophobic); particle size < 0.4µm; SA = 300 m ² /g	80, 340, 1200, or 5000 mg/m ³ ; groups of 5 male and 5 females Sprague-Dawley rats; 4 h whole body exposure; no further details	Details not provided	800 mg/m ³	³

Table 4. Acute toxicity studies

Ingredient/Concentration/Vehicle	Dose/Study Protocol	Results	LD₅₀ or LC₅₀	Reference
Silica (hydrophobic); particle size = 0.48 µm; SA = 200 m ² /g	0, 1260, 2830, or 6280 mg/m ³ ; groups of 5 male and 5 female Sprague-Dawley rats; 1 h whole body exposure; no further details	Details not provided	1260-2830 mg/m ³ ; no further details	³
Silica (hydrophobic); particle size = 0.54 µm; SA = 200 m ² /g	0 or 2190 mg/m ³ ; groups of 5 male and 5 female Sprague-Dawley rats; 4 h whole body exposure; no further details	All animals of the test group died	< 2190 mg/m ³	³
Silica (hydrophilic); particle size = 0.76 µm; SA = 200 m ² /g	2080 mg/m ³ ; 5 male and 5 female Sprague-Dawley rats; 4 h nose-only exposure; no further details	Details not provided	> 2080 mg/m ³	^{2,3}
Silica (hydrophobic); particle size = 0.95-2.15 µm; SA = 300 m ² /g	90 or 840 mg/m ³ ; groups of 5 male and 5 female Wistar rats; 4 h whole body exposure; no further details	Results similar as those listed below; no further details	90-840 mg/m ³	³
Silica (hydrophobic); particle size = 1.175-1.275 µm; SA = 130 m ² /g	210, 540, or 2100 mg/m ³ ; groups of 5 male and 5 female Wistar rats; 4 h whole body exposure; no further details	All animals died in high dose group within 2.5 h of exposure; necropsy of this group discovered eye opacity, lung enlargement with red areas, and white material in the nasal turbinates; in the mid-dose group, 7/10 animals died during exposure; necropsy of mid-dose group discovered opaque eyes, dark enlarged lungs with red areas, white material in nasal turbinates, and red areas in the intestines; all rats in low-dose group survived; at necropsy, low-dose group had dark lungs with white and red areas	540 mg/m ³	³
Silica (hydrophobic); particle size = 1.4-1.8 µm; SA = 80 m ² /g	1094, 2863, 3730, or 5382 mg/m ³ ; groups of 5 male and 5 female Wistar rats; 4 h whole body exposure; no further details	Details not provided	2863-3730 mg/m ³ ; no further details	³
Silica (hydrophobic); particle size = 1-5 µm (83%) and 5-100 µm (17%); SA = 300 m ² /g	120, 400, 1370, or 3360 mg/m ³ ; groups of 3 male and 3 female Sprague-Dawley rats; 4 h whole body exposure; no further details	Details not provided	660 mg/m ³	³
Silica; particle size ≤ 3 µm (84%); no further details	10 Sprague-Dawley rats; 4 h whole body exposure; no further details	Clinical signs included nasal discharge during exposure and crusty eyes and nose and alopecia during the 14-d observation period; reduced body weight gain observed in females in the first 3 days post-exposure and then returned to normal; discolored lungs observed in 1 rat at necropsy	> 2.08 mg/m ³	²
Silica (hydrophilic); 56% of particles < 5 µm; SA = 200 m ² /g	139 mg/m ³ ; 5 male and 5 female Wistar rats; 4 h nose-only exposure; no further details	No clinical signs of toxicity and no organ abnormalities at necropsy	> 139 mg/m ³	^{2,3}
Silica (hydrophobic); particle size < 5 µm (56%) and ≥ 7.7 µm (44%); SA = 200 m ² /g	477 mg/m ³ ; 5 male and 5 female Wistar rats; 4 h whole body exposure; rats were observed for 14 days post-exposure and periodically weighed; no further details	No mortalities during exposure or observation period; body weights decreased during the first 2 days after exposure before returned to normal; necropsies were unremarkable	> 477 mg/m ³	⁸
Silica (hydrophobic); particle size = 6.3-7.7 µm; SA = 300 m ² /g	400, 700, or 2000 mg/m ³ ; groups of 5 male and 5 females Sprague-Dawley rats; 4 h nose-only exposure; no further details	Details not provided	600 mg/m ³	³
Silica (hydrophobic); particle size = 7.0-7.1 µm; SA = 300 m ² /g	400 or 600 mg/m ³ ; groups of 5 male and 5 females Sprague-Dawley rats; 4 h nose-only exposure; no further details	Details not provided	500 mg/m ³	³
Silica (hydrophobic); particle size = 7.2-7.7 µm; SA = 130 m ² /g	900 or 2200 mg/m ³ ; groups of 5 male and 5 females Sprague-Dawley rats; 4 h nose-only exposure; no further details	4/10 rats in high dose group died; severe discoloration of the lungs was noted in the rats that died during the study; surviving rats had normal lungs except 1 male and 2 females with trace discoloration	> 2200 mg/m ³	³
Silica (hydrophilic); SA = 200 m ² /g	0 or 191,300 mg/m ³ ; albino rats; 1 h nose-only exposure; no further details	Details not provided	> 191,300 mg/m ³	³

Table 4. Acute toxicity studies

Ingredient/Concentration/Vehicle	Dose/Study Protocol	Results	LD₅₀ or LC₅₀	Reference
Silica (hydrophilic); SA = 380 m ² /g	0 or 207,000 mg/m ³ ; 10 male albino rats per dose group; 1 h nose-only exposure; no further details	Vigorous cleansing activity, hypoactivity, abdominal respiration, gasping, nasal exudation, closed eyes, crust-like material around nose and mouth, and chalky fur up to 2 days post-exposure	> 207,000 mg/m ³	³
Silica (hydrophobic); no further details	250 mg/m ³ ; groups of 10 male Wistar rats; 6 h whole body exposure; no further details	Clinical signs of toxicity included preening, hunching and occasional prostration; no significant findings at necropsy	> 250 mg/m ³	³
Silica (hydrophobic); no further details	670, 690, 710, 1540, or 3150 mg/m ³ ; 10 male albino rats per group; 1 h exposure; no further details	Details not provided	> 3150 mg/m ³	³
Silica (hydrophobic); no further details	250 mg/m ³ ; groups of 10 male English short hair guinea pigs; 6 h whole body exposure; no further details	Clinical signs of toxicity included preening; consolidation observed in the lungs of 2/9 animals; no significant findings at necropsy	> 250 mg/m ³	³

Table 5. Repeated dose toxicity studies

Ingredient/Concentration/ Dose/Vehicle	Species/Strain/Cell	Method	Results	Reference
<i>Dermal Toxicity</i>				
Silica; 0, 5, or 10 g/kg/d	2 male and 2 female albino rabbits per dose group; no further details	Test material applied for 18 h/g, 5 d/week for 3 weeks on intact and abraded skin; no further details	No signs of systemic toxicity and no gross or microscopic pathological findings; Silica content of blood, urine, spleen, liver, and kidney similar to controls	3
<i>Oral Toxicity</i>				
Hydrated Silica; 38.45, 79.78, or 160 g/male and 37.02, 72.46, or 157.59 g/female (1.25%, 2.5%, or 5%); in feed	Groups of 40 male and 40 female B ₆ C ₃ F ₁ mice	93-week dietary study	No remarkable findings with regards to hematology or organ weights; no differences between treated groups and controls with mortality; feed consumption was increased in mid- and high-dose groups while weight increases in males weeks 15-50 and in females weeks 30-50 were reduced	35
Hydrated Silica; 7500 mg/kg/d; in feed	6 albino male rats; no further details	Dietary study where rats received test material in feed 5 times per week for 2 weeks	All animals lost weight during treatment, but gained over the weekend and during post-observation period; no significant effects on the organs	2,3
Hydrated Silica; 16.5 g/kg/d (10% w/w) in group 1 and 5.8 g/kg/d (5% w/w) and 24.2 g/kg/d (20% w/w) in group 2; in feed	Two groups of 5 male and 5 female Sprague-Dawley rats	14-day dietary study; group1 received 16.5 g/kg/d test material for 14 days and group2 received 5.8 g/kg/d for days 1-10 and 24.2 g/kg/d for days 11-14; pathological exam not performed	NOAEL ≥ 24.2 g/kg/d; no clinical signs of toxicity or significant changes in feed/water consumption, body weight gains, or behavior	2,3
Hydrated Silica; average particle size = 15 µm; 1500 mg/kg/d; in aqueous solution	Female inbred rat; no further details	Daily gavage for 1 month	No clinical signs of toxicity or significant changes in feed consumption, body weight gain, or behavior; Silica content in liver = 1.5 µg, in kidney = 6.4 µg, and in spleen = 5.3 µg	2,3
Hydrated Silica; 0, 250, 1000, or 4000 mg/kg/d (0%, 0.5%, 2%, or 8%); in feed	Groups of 10 male and 10 female Wistar rats	13-week dietary study	NOEL = 4000 mg/kg/d; high dose group had increased feed intake associated with a decreased feed efficiency; increased mean absolute and relative weight for the cecum in the high dose group; no gross or microscopic pathological changes in any dose group	3
Hydrated Silica; 0, 2170, or 7950 mg/kg/d in males or 0, 2420, or 8980 mg/kg/d in females (0%, 3.2%, or 10%); in feed	Groups of 12 male and 12 female CD-1 rats	6-month dietary study	NOAEL = 8980 mg/kg/d; no clinical signs of toxicity or significant changes in feed consumption, growth, hematology, clinical chemistry, or gross or microscopic pathology	2,3
Hydrated Silica; 143.46, 179.55, or 581.18 g/male and 107.25, 205.02, or 435.33 g/female (1.25%, 2.5%, or 5%); in feed	Groups of 40 male and 40 female Fischer 344 rats	103-week dietary study	No differences between treated groups and controls with body weight, feed intake, behavior, or hematological or chemistry parameters; liver weights in females in the mid- and high-dose groups were lower at 12 to 24 months; no significant histopathological findings	35
Silica; 0.2%, 1.0%, or 2.5% in feed	Groups of 10 male rats; no further details	Dietary study 28 days in length; no further details	No adverse effects or unscheduled mortalities; gross necropsy findings unremarkable	36
Silica; 0.8 g/kg/d in feed; no further details	15 male and 15 female CD rats	Dietary study 4 weeks in length; no further details	No treatment-related effects observed	34
Silica; 0, 500, 1000, or 2000 mg/kg/d with a 2-week stepwise increase to 16,000 mg/kg/d (approximately 25% feed intake)	Groups of 5 male and 5 female Wistar rats	Dietary study 5 weeks in length for low- and mid-dose groups and 8 weeks for high-dose group	LOEL = 1000 mg/kg/d; NOEL = 500 mg/kg/d; high dose group had significant reduction in body weight associated with decreased feed intake; no significant changes in biological parameters or macroscopic findings; at microscopic examination, liver had severe atrophy in the epithelium	8
Silica (hydrophilic); 0, 700, 2100, or 3500 mg/kg/d (0%, 1%, 3%, or 5%); in feed	Groups of 15 male and 15 female Charles River rats	13-week dietary study; interim necropsies of 3 males and 3 females performed after 45 d	NOAEL = 3500 mg/kg/d; no clinical signs of toxicity or significant changes in feed consumption or growth rate; no gross or microscopic pathological changes; no increase in Silica content in the liver, kidney, spleen, blood, or urine after 45 or 90 d in the high dose group	2,3
Silica (hydrophobic); 0, 1000, 2000, or 4000 mg/kg/d (0%, 1%, 2%, or 4%); in feed	Groups of 10 male and 10 female Charles River rats	13-week dietary study	No clinical signs of toxicity; no gross or microscopic pathological changes; no changes in behavior or growth; a minimal change in the thyroid gland morphology was observed in the mid- and high-dose males	3
Silica; 3.2% or 10%; in feed	12 male and 12 female rats; no further details provided	6-month dietary study; no further details provided	No mortalities; only clinical sign as discolored stools; no remarkable findings with growth and development, feed consumption, histology, hematology, or at necropsy	36

Table 5. Repeated dose toxicity studies

Ingredient/Concentration/ Dose/Vehicle	Species/Strain/Cell	Method	Results	Reference
Silica; 0.78 or 3.00 g/week males and 0.55 or 2.11 g/week females; in feed	12 male and 12 female rats; no further details provided	6-month dietary study; no further details provided	Increase in the number of leukocytes in high dose females and of eosinophils in high dose males; dose-dependent decrease in glucose concentration and AP activity in male rats ; dose-dependent decrease in serum calcium concentration; reduced liver and prostate weights; no effects on body weight gain, feed consumption, blood chemistry, or urinalysis	36
Silica; 500 mg/kg/d	20 male and 20 female Wistar rats	6-month gavage study; 5 times/week	No clinical signs of toxicity and no macroscopic findings	8
Silica; 0.8 g/kg/d in feed; no further details	Male and female Beagle dogs; no further details	Dietary study 4 weeks in length; no further details	No treatment-related effects observed	34
<i>Inhalation Toxicity</i>				
Hydrated Silica; no further details	10 or 100 mg/m ³ ; 24 male CD rats; 6 h/d for 3 days followed by recovery periods of 1, 8, 30 or 90 days	Transient inflammatory tissue reaction observed in low dose group at 24 h post-exposure that resolved within 8 days; recovery in high dose group similar to that in low dose group	Not reported	42
Hydrated Silica (precipitated and gel) and Silica, aerosolized; particle sizes not provided; 1, 5, or 25 mg/m ³	10 male and 10 female Wistar (Cri:WI)WU BR rats per dose group	5-day study with 3-month recovery period; 6 h/d; nose-only exposure	No clinical signs of toxicity during exposure; silica levels in the tracheobronchial lymph nodes were below detection limits in all 3 groups; silica was found in the lungs at day 1 but had cleared by 3 months; all 3 test materials induced biomarkers of cytotoxicity in bronchoalveolar lavage (BAL) fluid, increases in lung and tracheobronchial lymph node weights, and histopathological lung changes in the high dose groups at day 1 post exposure; mid dose only induced histopathological changes and changes in BAL fluid; all effects except slight histopathological lung changes at the higher exposure levels reversed during the recovery period; low dose caused no adverse effects	7
Hydrated Silica, aerosolized; particle size not provided; 30 mg/m ³	45 male Fischer 344 rats	8-day study with a 112-day recovery; 6 h/d	Early and transient influx of cells into the lung tissue during exposure which returned to normal by day 12; BAL protein, lipid phosphorus, and saturated dipalmitoyl phosphatidyl-choline levels increased immediately after exposure but recovered day 5 post exposure; no differences between controls and treated lungs as to weight, DNA-, protein-, or hydroxyproline-content.	37,38
Hydrated Silica, aerosolized; particle size not provided; 0, 10.1, 50.5, and 154 mg/m ³ ; diluted 4:1 with deionized, distilled water	Male CD BR rats; no further details provided	4-week study with a 10- or 94-day recovery period; 6 h/d, 5 d/week	NOAEL=10.1 mg/m ³ ; dose-dependent increase in mean lung weight and lung to body weight ratio after 4 weeks of exposure in the mid and high dose groups; mean lung to body weight ratio continued to increase in the high dose group 10 days into recovery, but was similar to controls after 3 months; dust laden alveolar macrophages, neutrophilic infiltration, and Type II pneumocyte hyperplasia observed in the alveolar duct region of the lungs; pulmonary lesions progressively decreased in rats after the 10 day and 3 month recovery period; most dust-laden alveolar macrophages were cleared from the lungs 3 months post-exposure, but small numbers of minute silicotic nodule-like lesions were present in the alveolar ducts and perivascular regions where dust laden alveolar macrophages had aggregated; minimal collagen deposition observed in the silicotic nodule-like lesions but the lesions did not increase in size or number over time.; there was an increase in mean neutrophil count and globulin concentration and a decrease in mean lymphocyte count at the end of the treatment for the high dose group which were both still present after 3 months of recovery; tracheal and mediastinal lymph nodes were enlarged with nodular aggregates of dust-laden alveolar macrophages and hyperplastic reticulo-epithelial (RE) cells	39,40

Table 5. Repeated dose toxicity studies

Ingredient/Concentration/ Dose/Vehicle	Species/Strain/Cell	Method	Results	Reference
Hydrated Silica, aerosolized; particle size not provided; 0, 10, 50, or 150 mg/m ³	Groups of 25 male Crl:CD(SD)BR rats; no further details provided	4-week study with 10 day or 3-month recovery period; 6 h/d, 5 d/week	Dose-dependent lesions observed in the mid and high dose groups but not in low dose group; particles mostly phagocytized by alveolar macrophages in alveolar duct region and a few free particles were observed in Type I pneumonocytes in the alveoli; particle-laden alveolar macrophages directly penetrated into the bronchiolar interstitium from alveoli and accumulated in bronchus-associate lymphoid tissue, peribronchial, or perivascular interstitium and accumulated in the tracheobronchial lymph nodes; some particle-laden alveolar macrophages in the bronchus-associated lymphoid tissue transmigrated directly into bronchial lumen through the epithelium; migrated particle-laden alveoli macrophages observed to be necrotic and released particles in the tracheobronchial lymph nodes; at 3 months, lungs of the low dose group were normal while lungs of the mid dose group had a small number of tiny nodular aggregates of dust-laden alveoli macrophages and epithelioid cells were observed with one rat observed with a few silicotic nodules in perivascular regions adjacent to the bronchioles; high dose recovery group had decreased numbers of particle-laden alveoli macrophages that were sharply circumscribed in the alveoli; 3/10 rats had silicotic nodules in the perivascular region of the bronchioles	41
Hydrated Silica; particle and agglomerate/aggregate size 1 to ~120 µm; 35 mg/m ³	Male and female Wistar rats	13-week study with a 52-week recovery period; 6 h/d, 5 d/week	Slightly decreased body weight and increased lung and thymus weights were observed; necropsy revealed swollen and spotted lungs and enlarged mediastinal lymph nodes; microscopic examination revealed accumulation of alveolar macrophages, intra-alveolar leukocytes, and increased septal cellularity; accumulation of macrophages observed in the lymph nodes; collagen content in the lungs was slightly increased; effects of exposure mostly resolved within 26 weeks of recovery although accumulations of Silica and macrophages in the mediastinal lymph nodes were still present	43
Silica, aerosolized; 0 or 6.9 mg/m ³	80 male Sprague Dawley rats	12-month study; 5.5 to 6 h/d, 5 d/week	LOAEL=6.9 mg/m ³ ; a few macrophage aggregates found in lungs; interstitial fibrosis associated with dense collections of mast cells was a trend in rats exposed to Silica, some incidences also occurred in some control animals; fibrosis was comparable between test and control groups	49
Hydrated Silica, aerosolized; particle size not provided; measurements ranges from 25 to 74 mg/m ³	Groups of 35 Wistar rats; no further details provided	12-month study; 8 h/d, 5 d/week	Deaths occurred in 74% (26/35) and were treatment-related; majority of deaths from pulmonary vascular obstruction and emphysema from months 4-9; after 6 months, aggregations of focal pigmentation visible as reddish-tan foci of dust; greatly enlarged and firm lymph nodes were observed	47
Hydrated Silica, aerosolized; particle size not provided; 126 mg/m ³	84 rats; no further details provided	15-month study with up to 12-month recovery period; 8 h/d, 5 d/week	No treatment-related differences between test and control groups, most deaths were due to intercurrent infection; lung weights increased during exposure but returned to normal during recovery; particle phagocytosing macrophages accumulated in alveoli, bronchioles, and lymphoid tissue; hilar lymph nodes were mildly enlarged but disappeared at treatment termination; epithelial proliferation was minimal; mild deposition of reticulin fibers occurred in alveoli without collagen formation; no epithelization or pleural changes and no neoplasia; emphysematous effects may have been due to aging and recurrent epizootic pneumonia; silicotic processes were absent	48
Hydrated Silica (precipitated and gel) and Silica, aerosolized; particle size ≤4.7 µm; 0 or 15 mg/m ³	20 male Hartley guinea pigs	12-month study; 5.5 to 6 h/d, 5 d/week	Few macrophage containing particles of Silica were observed in the lungs and lymph nodes	49

Table 5. Repeated dose toxicity studies

Ingredient/Concentration/ Dose/Vehicle	Species/Strain/Cell	Method	Results	Reference
Hydrated Silica, aerosolized; particle size not provided; 0 or 126 mg/m ³	82 guinea pigs; no further details provided	24-month study; 8 h/d, 5 d/week; recovery period of up to 12 months	No treatment-related differences between test and control groups; lung weights increased during exposure but returned to normal during recovery; particle phagocytosing macrophages accumulated in alveoli, bronchioles, and lymphoid tissue; hilar lymph nodes were enlarged but disappeared at treatment termination; epithelial proliferation was minimal; mild deposition of reticulin fibers occurred in alveoli without collagen formation; no epithelization or pleural changes and no neoplasia; complete reversibility of Silica retention and inflammatory response with 6 months of recovery; silicotic processes were absent	48
Hydrated Silica, aerosolized; particle size not provided; 0 and 126 mg/m ³	50 rabbits; no further details provided	12-month study; 8 h/d, 5 d/week; recovery period of up to 12 months	No treatment-related differences between test and control groups; lung weights increased during exposure but returned to normal during recovery; particle phagocytosing macrophages accumulated in alveoli, bronchioles, and lymphoid tissue; hilar lymph nodes were enlarged but disappeared at treatment termination; epithelial proliferation was minimal; mild deposition of reticulin fibers occurred in alveoli without collagen formation; no epithelization or pleural changes and no neoplasia; silicotic processes were absent	48
Hydrated Silica, aerosolized; particle size not provided; 0, 28, 134, or 360 mg/m ³	65 New Zealand white rabbits; sex not reported	9-month study for mid- and high-dose groups; 27- month study for low-dose and control groups; 8 h/d, 5 d/week; recovery period not described	LOAEL = 28 mg/ m ³ ; mid- and high-dose became distressed during exposure; fewer clinical signs that commenced later and receded more quickly were observed at lower concentrations: dyspnea and shortness of breath accompanied by cyanosis; elevated right and left ventricular pressures were concentration and time related; emphysema observed in high-dose group which decreased after treatment termination; pulmonary emphysema, vascular stenosis, alveolar cell infiltration, sclerosis, and epithelization granulomatosis, macrophage catarrh were observed; lesions were observed in liver, spleen and kidney; after 6 months of exposure, the cardiac pressure of the low dose group increased steadily; at 24 months, the elevation was 64% over pre-exposure pressure but effect was partially reversed with termination of treatment (34% after 12 months); the researcher reported concomitant radiographic changes, electrocardiographic deviations, modification of lung functions, hematolytic changes, anatomical cor pulmonale, congestive cardiac failure, emphysema, and chemical pneumonitis	46
Hydrated Silica (precipitated and gel) and Silica, aerosolized; particle size ≤4.7 μm; 0 or 15 mg/m ³	10 male <i>Macaca fascicularis</i> monkeys	13- or 18-month study; 6 h/d, 5 d/week	Decrease in lung respiratory volume and ventilatory mechanics more marked in the Silica group; dynamic pulmonary compliance, forced vital capacity, inspiratory capacity, total lung capacity, and forced expiratory flow were decreased; average flow resistance and closing volume were increased; lower lung volumes were observed in precipitated Hydrated Silica group; reductions in ventilatory performance and mechanical parameters, dynamic lung compliance, and forced expiratory flow in gel Hydrated Silica group; cytoplasmic changes in macrophages in the lungs and tracheal lymph nodes were observed; large numbers of macrophages and mononuclear cell aggregates were observed in the lungs; reticulin fibers were present in the aggregates in all 3 groups; in 6/10 monkeys exposed to Silica, collagen in varying quantities was found in 5 to 50% of the aggregates, with signs of early nodular fibrosis; in 3/10 monkeys no or little collagen was present; no or very few collagen fibers were observed in aggregates in the lung of Hydrated Silica groups; a review of this study noted that the monkeys may have been exposed to quartz or asbestos fibers during the course of the experiment	2,49

Table 5. Repeated dose toxicity studies

Ingredient/Concentration/ Dose/Vehicle	Species/Strain/Cell	Method	Results	Reference
Silica, aerosolized; no further details provided	15 Fischer 344 rats; no further details provided	8-day study with up to 120-day recovery period	Initial alveolar inflammation subsided by recovery day 12	38
Silica; particle sizes not provided; 0, 17, 44, or 164 mg/m ³	Groups of 40 male and 40 female Wistar rats; 6 male and 6 female rats served as unexposed controls	14-day study; 6 h/d, 5 d/week; whole body exposure chamber	Respiratory distress observed in all groups, and 1 female in the high dose group died; body weights and feed consumption were decreased in the males in the mid and high dose groups; hematological measurements were unremarkable; lung weights were increased in both sexes (47%, 65%, and 86% for the low, mid, and high dose groups, respectively) compared to controls; absolute and relative liver weights were decreased in males, but not females; dose-dependent changes observed in lungs (i.e., pale, spotted and/or spongy, occasionally irregular surface, alveolar interstitial pneumonia, early granulomata); mediastinal lymph nodes were enlarged	43
Silica; particle sizes not provided; 0, 46, 180, or 668 mg/m ³	Groups of 30 male and 30 female Wistar rats; 6 male and 6 female rats served as unexposed controls	14-day study; 6 h/d, 5 d/week; whole body exposure chamber	Respiratory distress was observed in all groups, and 1 male died in the high dose group; body weights were decreased in male mid and high dose groups and in high dose females; feed consumption was decreased in both sexes in the mid and high dose groups; lung weights were increased in both sexes compared to controls (males 25%, 39%, and 68%; females 34%, 50%, and 86% in the low, mid, and high dose groups, respectively); decreased liver weights observed in males of all dose groups and the high dose group females; lungs were spotted, swollen, and had irregular surfaces in the high dose groups as well as interstitial pneumonia and early granulomata; silica was observed in the mediastinal lymph nodes in the mid and high dose groups and 1 rat in the low dose group; an accumulation of alveolar macrophages and particulate material was observed in the lungs of males in the mid and high dose group	43
Silica; aerosolized; particle size 50-79 nm (nanoparticles); 0, 0.4 mg/m ³ , 1.4 mg/m ³ , or 5.4 mg/m ³	Groups of 15 male Sprague-Dawley rats	4- week study with up to 28 day recover; 6 h/d, 5 d/week; nose-only inhalation system	Minimal toxic effects included temporary decrease in body weight (high concentration group), increased levels of red blood cells (all concentration groups) and hemoglobin concentrations (low and middle concentration groups); no significant lung histopathological findings or adverse changes in inflammatory markers in bronchoalveolar lavage fluid; no significant toxicological or inflammatory changes in the lungs of the exposed groups during all recovery days	44

Table 5. Repeated dose toxicity studies

Ingredient/Concentration/ Dose/Vehicle	Species/Strain/Cell	Method	Results	Reference
Silica; particle size not provided; 1.3, 5.9, or 31 mg/m ³	Groups of 50 male and 50 female Wistar rats	13-week study with up to 39-week recovery; 6 h/d, 5 d/week; full body exposure	NOEL=1.3 mg/m ³ ; no mortalities during treatment or recovery; dose dependent increase in respiration rates; body weight gains were depressed; RBC count was increased in high dose males; white blood cells (WBC) were elevated in both males and females of mid and high dose groups but the concentration-response relationship was poor; blood cell counts returned to normal by week 39; necropsy revealed swollen and spotted lungs and enlarged mediastinal lymph nodes at 13 weeks with a dose-dependent severity; all groups had increased lung weights and collagen content, these effects were reduced to control levels by the end of recovery except for collagen content in males in the mid- and high-dose groups; in high-dose group post treatment, the average Silica amount in the lungs was 0.2 mg; no Silica above control levels could be detected in any rat at the end of recovery; microscopic evaluation after treatment revealed accumulation of alveolar macrophages and granular material, cellular debris, polymorphonuclear leukocytes, increased septal cellularity, alveolar bronchialization, focal interstitial fibrosis, cholesterol clefts, and granuloma-like lesions in the lung; no fibroblastic activity noted in lung lesions nor was there hyalinization; all pulmonary lesions types were more marked in males than in females; accumulation of macrophages was observed in the mediastinal lymph node at 13 and 26 weeks; focal necrosis and slight atrophy of the olfactory epithelium noted at week 13; interstitial fibrosis was not observed until 13 weeks post-exposure, with increasing incidence especially in the high-dose group, and a few in the mid-dose group	43
Silica, aerosolized; particle size not provided; 8 and 40 mg/m ³	Female Wistar rats; no further details provided	3-month study with a 7 day or 3-week recovery period; 1 h/d, 5 d/week	No macroscopic changes noted; dust cells noted in the lungs which decreased post-exposure; no fibrosis of the reticulo-cellular type and normal parenchyma of the lungs; decrease of Silica content in the lungs was observed 7 and 48 days after treatment termination with almost no Silica in the lungs after 3 months	2
Silica, aerosolized; mean diameter 0.81 µm; 0 or 50.4 ± 19 mg/m ³	4 male Fischer 344 rats; control group details not provided	13-week study with up to 8 months recovery period; 6 h/d, 5 d/week	Silica load increased quickly during the first 6.5 weeks of exposure (0.76 mg/lung) but less so after 13 weeks (0.88 mg/lung); Silica burden disappeared rapidly from lung tissue during recovery (15% after 12 weeks; 6% after 32 weeks); BAL showed mean cell numbers in the lavage increased 5- to 15-fold compared to control; cells comprised > 50% polymorphonuclear leukocytes (PMN) and some 2% lymphocytes whereas the control lavages only contained < 1% of either cell type; protein content and LDH and glucuronidase activities were markedly higher than controls; all BAL markers approached normal levels after 13 weeks recovery in most rats; invasion of neutrophils and macrophages into the alveoli noted after 6.5 weeks that decreased during recovery; fibrosis observed in alveolar septa which subsided during recovery; intensely stained TUNEL-positive cells were detected throughout the terminal bronchiolar epithelium and through the parenchyma of the lungs at exposure end	45

Table 5. Repeated dose toxicity studies

Ingredient/Concentration/ Dose/Vehicle	Species/Strain/Cell	Method	Results	Reference
Silica; particle size not provided; 25 to 85 mg/m ³	25 Wistar rats, half males and half females; control group had 42 rats; no further details provided	6-month study with 6-month recovery period; rats were exposed in inhalation chambers to aerated Silica for 8 h/d with passive exposure to settling dust the remaining 16 h; exposures were 5 d/week	LOAEL=53 mg/m ³ ; 44% rats died during exposure with most dying from pulmonary vascular obstruction and emphysema beginning at month 4; focal pigmentation was conspicuous after 3 months of exposure with profusely scattered small, dark-pink discrete but irregular subpleural foci of reaction; congestion of the lungs and lymph node enlargement observed after 3 months; an incipient tendency toward pulmonary emphysema observed after 4 months of exposure with lung distension and superficial alveoli dilation; atelectasis noted in some rats after 4 to 5 months; mononuclear macrophages forming clusters of plasma cells and lymphocytes observed in lung lymphatic system; alveolar space was infiltrated with large vacuolated cells; cytoplasm had a foamy appearance with macrophages fused to giant cells; progressive nodule formation in the lung parenchyma and peri- and paravascular, in some cases parabronchiolar distribution and accumulation, consisting of central macrophages and surrounding plasma cells, some nodules enveloped by an epithelial layer of cells; necrosis noted in the central zone of the nodules with tendency toward fibrosis in the nodules and evidence of progressive emphysematous processes around the nodules; average Silica load in the lung after 3 months was 1.5 mg/lung and reduced to 0.3 mg/lung at the end of recovery	47
Silica, hydrophobic and aerosolized; particle size not provided; 0, 10, 50, or 150 mg/m ³	Male rats; no further details provided	12-month study; 6 h/d, 5 d/week	No effects observed at lowest concentration; peribronchial lymph nodes enlargement and white foci on the lung surfaces and collections of foamy macrophages within the alveoli were observed in 50 and 150 mg/m ³ groups	3
Silica, aerosolized; 85% particles between 1 to 10 µm; 25 to 85 mg/m ³	Male and female albino guinea pigs, number per experiment described in Methods; 80 control animals	Up to 24 months; whole body exposure for 8 h/d with 16 h passive exposure to settling dust; study conducted as 3 experiments: Experiment 1: 40 animals exposed for 24 months, Experiment 2: 15 or 18 animals exposed for 12 or 24 months, respectively, with variable recovery periods up to 12 months, and Experiment 3: 17 animals exposed for 12 months with a 1-month recovery period and a re-exposure for 8 to 24 h	Focal pigmentation and lymph node enlargement after 1 month; lung emphysema after 4 to 8 months of exposure; atelectasis observed histologically with dominant response of bronchial and peribronchiolar intra-alveolar accumulations of giant cells; at 8 to 12 months there was incipient atrophy of infiltrated alveoli with compensatory expansion of adjacent alveoli; a combined effect of atelectasis and consolidation around bronchiole was noted with bronchioli distortion, along with incipient fibrosis around bronchioli and shrunken alveoli; a marked tendency toward cuboidal epithelization of atelectatic alveoli was noted by the end of the second year of exposure; medullary hyperplasia with the formation of slight amounts of reticulum was prominent during the second year of exposure in the lymphatic system with no inflammation, sinus catarrh, or fibrosis were noted in the lymph nodes; in the recovery phase after 12 months of exposure, a progressive recovery began almost immediately with no macroscopically visible anomalies after 1 year of recovery; residual sequelae of the tissue reactions were emphysema, mural fibrosis, and bronchiolar and bronchial ectasia stenosis	50
Silica, aerosolized; particles between 1 to 10 µm; 25 to 85 mg/m ³	10 New Zealand white rabbits; no further details provided	12-month study with a 6- and 12-month recovery period; 8 h/d	A progressive functional incapacitation and increased hematocrits observed in the majority of the rabbits, possibly due to the combined effect of pulmonary vascular obstruction and emphysema; Blood pressure changes (both increases and decreases) observed in the majority of the animals which partially recovered with discontinuation of treatment; essential pulmonary changes included peribronchiolar cellular catarrh, mural cellular infiltration along with deposition of reticulum and some collagen, the formation of peri-vascular cellular nodules, ductal stenosis, and emphysema; during recovery, the cellular reactions and emphysema regressed but minor focal alveolar mural collagen persisted.	51

Table 5. Repeated dose toxicity studies

Ingredient/Concentration/ Dose/Vehicle	Species/Strain/Cell	Method	Results	Reference
Silica, aerosolized; particle size not provided; 15 mg/m ³	5 <i>Macacus mulatta</i> monkeys with 15 untreated control monkeys; no further details provided	12-month study; a monkey was killed and necropsied at 3 and 6 months	Body weight gains decreased and activity decreased during the initial exposures; at 3 months, emphysema detectable with considerable cellular infiltration of the alveoli and alveolar septa associated with distention of alveoli or accumulation of exudate and macrophages; after 12 months, the lesions were marked pulmonary emphysema, alveolar wall sclerosis, vascular occlusions, and cor pulmonale, which was attributed to the emphysema and alveolar wall destruction; tracheobronchial lymph nodes were slightly enlarged but not fibrotic	52
Silica, hydrophobic and aerosolized; particle size not provided; 0, 10, 50, or 100 mg/m ³	Male <i>Macaca fascicularis</i> monkeys	12-month study with a 2- or 24-month recovery; 6 h/d, 5 d/week	No effects observed at the lowest concentration; mid-and high groups had interstitial fibrosis, which did not resolve or progress during recovery; peribronchial lymph nodes were enlarged	3

Table 6. Genotoxicity studies

Ingredient/Concentration/Dose	Species/Strain/Cell	Method	Results	Reference
<i>In Vitro</i>				
Hydrated Silica; up to 10,000 µg/plate with and without metabolic activation	<i>S. typhimurium</i> strains TA 98, TA100, TA1535, TA 1537, and TA 1538	Ames test	Negative; not cytotoxic	2,3
Hydrated Silica; concentration not provided; without metabolic activation	<i>S. typhimurium</i> strain TA 1530, G-46	Ames test	Negative	2,3
Hydrated Silica; up to 10,000 µg/plate with and without metabolic activation	<i>Escherichia coli</i> WP2	Tryptophan reversion	Negative; not cytotoxic	2,3
Hydrated Silica; concentration not provided; without metabolic activation	<i>Saccharomyces cerevisiae</i> (D3)	Forward mutation	Negative	2,3
Hydrated Silica; 1-1000 µl/ml without metabolic activation	Human embryonic lung cells (Wi-38)	Chromosome aberration	No significant clastogenic activity	2,3
Silica; up to 10 M; details not reported	<i>Bacillus subtilis</i>	Rec assay	Negative	53
Silica; up to 10 M; details not reported	<i>E. coli</i> and <i>S. typhimurium</i> strains TA 98, TA 100, TA 1535, and TA 1538	Ames test	Not genotoxic	53
Silica (hydrophobic); 1580 µg/plate with and without metabolic activation	<i>S. typhimurium</i> strains TA 98, TA100, TA 1537	Ames test	Negative, not cytotoxic	2,3
Silica (hydrophilic); up to 5000 µg/plate with and without metabolic activation	<i>S. typhimurium</i> strains TA 98, TA 100, TA 1535, TA 1537, and TA 1538	Ames test (7 studies with identical test methods and findings)	Negative; not cytotoxic	2,3
Silica (hydrophilic); up to 10,000 µg/plate with metabolic activation	<i>S. typhimurium</i> strains TA 98, TA 100, TA 1535, TA 1537, and TA 1538	Ames test	Negative; not cytotoxic	2,3
Silica; up to 10,000 µg/plate in DMSO with and without metabolic activation	<i>E. coli</i> strain WP 2 and <i>S. typhimurium</i> strains TA98, TA100, TA1535, TA1537, TA1538	Ames test	Not genotoxic	54
Silica in a toluene extract; up to 1580 µg/plate with and without metabolic activation	<i>E. coli</i> strain WP2uvrA and <i>S. typhimurium</i> strains TA98, TA100, TA1535	Ames test; additional test performed with epoxide hydrolase inhibitor and glutathione depletor 1,1,1-trichloropropene-2,3-oxide was added to the activation mix in strain TA98 to increase sensitivity	Not genotoxic	8
Silica (hydrophobic); 5000 µg/plate with and without metabolic activation	<i>E. coli</i> WP2	Tryptophan reversion	Negative; not cytotoxic	2,3
Silica (hydrophobic); 5000 µg/plate with and without metabolic activation	<i>E. coli</i> WP2	Tryptophan reversion	Negative; not cytotoxic	2,3
Silica; up to 160 µg/cm ³	Chinese hamster lung fibroblasts	Micronucleus test	Weak, but significant, dose-dependent induction of micronuclei at cytotoxic concentrations; no clastogenicity observed in concentrations lower than cytotoxic levels	55
Silica; 19-300 µl/ml without metabolic activation and 250-1000 µl.ml with metabolic activation	Chinese hamster ovary (CHO) cells	Chromosomal aberration test	Negative	2
Silica (hydrophilic); 38-300 µl/ml without metabolic activation and 250-1000 µl/ml with metabolic activation	CHO cells	Chromosome aberration	No clastogenic activity	2,3
Silica; 10-250 µl/ml without metabolic activation and 100-500 µl/ml with metabolic activation	CHO cells	HGPRT assay	Negative	2
Silica; 68.9 and 137.9 µg/cm ²	Chinese hamster fibroblasts (V79) and human embryonic lung fibroblasts (HEL 299)	Single-cell gel/Comet assay	Dose-dependent increase in DNA migration in the gel in both cell lines	56
Silica; 0.3-1000 µl/ml; with and without metabolic activation	Primary rat hepatocytes	Unscheduled DNA synthesis	Negative; cytotoxic at 260-500 µl/ml	2,3

Table 6. Genotoxicity studies

Ingredient/Concentration/Dose	Species/Strain/Cell	Method	Results	Reference
Silica (hydrophilic); 10-250 µl/ml without metabolic activation and 100-500 µl/ml with metabolic activation	CHO cells	6-Thioguanine resistance	No significant mutagenic activity	^{2,3}
Silica (hydrophobic); 63-500 µl/ml with and without metabolic activation	CHO cells	Clastogenic activity; no further details provided	No clastogenic activity	^{2,3}
Silica (hydrophobic); 42-333 µl/ml with and without metabolic activation	CHO cells	Clastogenic activity; no further details provided	No clastogenic activity	^{2,3}
<i>In Vivo</i>				
Hydrated Silica; 1.4-5000 mg/kg	Mice (host) + <i>S. typhimurium</i> TA 1530, G-46 (indicator)	Gene mutation (host mediated) method; a single or 5 intra-peritoneal (i.p.) injections of <i>S. typhimurium</i> ; cells collected 3 h after last administration	No mutagenic activity	³
Hydrated Silica; 1.4-5000 mg/kg	Mice (host) + <i>S. cerevisiae</i> D3 (indicator)	Mitotic recombination (host mediated); a single or 5 i.p. injections of <i>S. cerevisiae</i> ; cells collected 3 h after last administration	No genotoxic activity	³
Hydrated Silica; 1.4-5000 mg/kg	Male Sprague-Dawley rats	Chromosome aberration study with rat bone marrow; animals were killed at 6, 24, or 48 h after oral dosing	Negative	³
Hydrated Silica; 1.4-5000 mg/kg	Male Sprague-Dawley rats	Chromosome aberration study with rat bone marrow; animals were killed at 6 h after oral dosing	Negative	³
Hydrated Silica; 1 x 1.4-5000 mg/kg	10 male Sprague-Dawley rats mated with 2 virgin female rats	Dominant lethal mutation assay; female animals were killed 14 days after mating for uterus examination; oral dosing	Negative	^{3,57}
Hydrated Silica; 5 x 1.4-5000 mg/kg	10 male Sprague-Dawley rats mated with 2 virgin female rats	Dominant lethal mutation assay; female animals were killed 14 days after mating for uterus examination; oral dosing	Negative	^{3,57}

Table 7. Dermal irritation and sensitization

Ingredient/Concentration/ Dose/Vehicle	Test System	Method	Results	Reference
<i>Irritation – Animal</i>				
Hydrated Silica; 500 mg as a 23% solution in methyl ethyl cellulose	12 rabbits; no further details	Dermal irritation study; test site occluded for 24 h; skin intact and abraded	No signs of irritation	³
Hydrated Silica; 20 mg	8 rabbits; no further details	Dermal irritation study; test site occluded for 24 h; skin intact and abraded	No signs of irritation	³
Hydrated Silica; 33 mg	6 rabbits; no further details	Dermal irritation study; test site occluded for 24 h; skin intact and abraded	Very slight erythema on 4 abraded sites and 5 intact sites at 24 h	³
Hydrated Silica; 190 mg	6 rabbits; no further details	Dermal irritation study; test site occluded for 24 h; skin intact and abraded	Very slight erythema on 3 abraded sites and 4 intact sites at 24 h	³
Hydrated Silica; 500 mg	3 rabbits; no further details	Dermal irritation study; test site occluded for 4 h; skin intact	No signs of irritation	³
Hydrated Silica; 500 mg	6 rabbits; no further details	Dermal irritation study; test site occluded for 24 h; skin intact	No signs of irritation	³
Hydrated Silica; 500 mg	12 rabbits; no further details	Dermal irritation study; test site occluded for 24 h; skin intact and abraded	No signs of irritation	³
Hydrated Silica; 500 mg as a 50% solution in olive oil	12 rabbits; no further details	Dermal irritation study; test site occluded for 24 h; skin intact and abraded	No signs of irritation	³
Hydrated Silica (hydrophobic); 500 mg as a 50% solution in olive oil	12 rabbits; no further details	Dermal irritation study; test site occluded for 24 h; skin intact and abraded	No signs of irritation	³
Silica (hydrophobic); 500 mg as a 6% solution in methyl ethyl cellulose	12 rabbits; no further details	Dermal irritation study; test site occluded for 24 h; skin intact and abraded	No signs of irritation	³
Silica (hydrophilic); 500 mg as a 12% solution in methyl ethyl cellulose	12 rabbits; no further details	Dermal irritation study; test site occluded for 24 h; skin intact and abraded	No signs of irritation	^{2,3}
Silica (hydrophobic); 500 mg in 2 ml water	6 rabbits; no further details	Dermal irritation study; test site occluded for 24 h; skin intact and abraded	No signs of irritation	³
Silica (hydrophilic); 500 mg in 3 ml saline	6 rabbits; no further details	Dermal irritation study; test site occluded for 24 h; skin intact and abraded	No signs of irritation on intact skin; slight erythema on 3 abraded sites	³
Silica (hydrophilic); 500 mg moistened with saline	6 rabbits; no further details	Dermal irritation study; test site occluded for 24 h; skin intact and abraded	Very slight erythema on 1 intact site at 24 h; very slight to well-defined erythema on abraded sites; no sign of erythema at 72 h post-patch removal	³
Silica (hydrophobic); 500 mg	6 rabbits; no further details	Dermal irritation study; test site semi-occluded for 4 h; skin intact	No signs of irritation	³
Silica (hydrophobic); 500 mg moistened with polyethylene glycol	6 rabbits; no further details	Dermal irritation study; test site occluded for 24 h; skin intact and abraded	No signs of irritation	³
Silica (hydrophobic); silane treated; 500 mg moistened with corn oil	6 rabbits; no further details	Dermal irritation study; test site occluded for 24 h; skin intact and abraded	No signs of irritation	³
<i>Sensitization – Animal</i>				
Hydrated Silica; 10% at induction, and 1%-20% at challenge; in distilled water	10 female Hartley albino guinea pigs treated; 5 guinea pigs control	Guinea pig maximization test	Not sensitizing	⁶²
<i>Sensitization- Human</i>				
17% Hydrated Silica in a facial mask (0.05 ml)	27 subjects (18 males, 9 females)	HRIPT; test sites pre-treated with 25% sodium lauryl sulfate (SLS; aq.; 0.05 ml) under occlusion for 24 h prior to induction; occluded	Not sensitizing	⁶³
45% Hydrated Silica; no further details reported	20 subjects (10 males, 10 females)	HRIPT; details not reported	Not sensitizing	²
Hydrated Silica (micronized gel) in a dusting powder; concentration and dose not reported	300 patients	Dermal irritation and sensitization study; details not reported	Non-irritating and non-toxic; little or no sensitizing reactions observed	⁵⁶
21.74% Silica in a facial powder in a 30% aq. solution	27 subjects (18 males, 9 females)	HRIPT; test sites pre-treated with 25% SLS aq. (0.05 ml) under occlusion for 24 h prior to induction; occluded	Not sensitizing	⁶⁴

Table 8. Ocular irritation

Ingredient/Concentration/ Dose/Vehicle	Test System	Method	Results	Reference
<i>Animal</i>				
Hydrated Silica; 0.1 ml of 50% dilution in olive oil	8 male New Zealand white rabbits	Ocular irritation study; eyes rinsed after 5 min in 3 rabbits or not rinsed in 5 rabbits	No signs of irritation in rinsed eyes; very slight erythema observed up to 24 h after instillation	8
Hydrated Silica; 100 mg instilled; 0.2 ml of 50% slurry	6 rabbits; no further details	Ocular irritation study; no further details	No signs of irritation	3
Hydrated Silica; 9 mg instilled	9 rabbits; no further details	Ocular irritation study; eyes rinsed after 2 sec in 3 rabbits, 4 sec in 3 rabbits, or not rinsed in 3 rabbits	No signs of irritation	3
Hydrated Silica; 40 mg instilled	3 rabbits; no further details	Ocular irritation study; no further details	No signs of irritation	3
Hydrated Silica; 100 mg instilled	3 rabbits; no further details	Ocular irritation study; no further details	Slight redness at 24, 48, and 72 h that resolved by day 4; mean score = 0.7	3
Hydrated Silica; 100 mg instilled	8 rabbits; no further details	Ocular irritation study; eyes rinsed after 5 min in 3 rabbits or not rinsed in 5 rabbits	No signs of irritation	3
Hydrated Silica; 100 mg instilled	9 rabbits; no further details	Ocular irritation study; eyes rinsed after 4 sec in 3 rabbits or not rinsed in 6 rabbits	No signs of irritation	3
Silica; 0.1 ml of 50% dilution in olive oil	8 male New Zealand white rabbits	Ocular irritation study; eyes rinsed after 5 min in 3 rabbits or not rinsed in 5 rabbits	No irritation	8
Silica (hydrophilic); 3 mg instilled	3 rabbits; no further details	Ocular irritation study; no further details	Slight to mild erythema that resolved by 48 h	65
Silica (hydrophobic); 3 mg instilled	9 rabbits; no further details	Ocular irritation study; eyes not rinsed in 3 rabbits, eyes rinsed after 2 sec in 3 rabbits, or after 4 sec in 3 rabbits	Transient slight to moderate conjunctival erythema observed and 1 and 4 h post-treatment that resolved within 24 h	3
Silica (hydrophilic); 3.5 mg instilled	6 rabbits; no further details	Ocular irritation study; no further details	Slight conjunctival erythema or chemosis in some animals at 24, 48 and 72 h; mean score 0.6 and 0.1, respectively; transient corneal opacity observed in 2 animals at 4 h	3
Silica (hydrophobic); 6 mg instilled	9 rabbits; no further details	Ocular irritation study; eyes not rinsed in 3 rabbits, eyes rinsed after 2 sec in 3 rabbits, or eyes rinsed after 4 sec in 3 rabbits	No signs of irritation	3
Silica (hydrophilic); 9 mg instilled; neat and in aqueous suspension; no further details	Rabbits; no further details	Draize ocular irritation study; rinsed and unrinsed eyes; no further details	Neat material was a mild irritant in unrinsed eyes (score = 2.4); no irritation in rinsed eyes or those treated with aqueous suspension	56
Silica (hydrophobic); 10 mg instilled	9 rabbits; no further details	Ocular irritation study; eyes not rinsed in 6 rabbits; eyes rinsed after 30 s in 3 rabbits	No signs of irritation	3
Silica; 10 mg instilled; neat and in aqueous solution; no further details	Rabbits; no further details	Ocular irritation study; some eyes rinsed after 2 sec, 4 sec, or not rinsed; no further details	Faint irritation in mucous tissues in eyes treated with neat material and not rinsed; no irritation in eyes that were rinsed and with aqueous solution	56
Silica (hydrophobic); 10-20 mg instilled	9 rabbits; no further details	Ocular irritation study; eyes not rinsed in 6 rabbits; eyes rinsed after 30 sec in 3 rabbits	No signs of irritation in rinsed eyes; 2 unrinsed eyes had slight erythema for 24 h after instillation; mean score = 0.1 at 24, 48, and 72 h	3
Silica (hydrophobic); 25 mg instilled	9 rabbits; no further details	Ocular irritation study; eyes not rinsed in 6 rabbits; eyes rinsed after 30 sec in 3 rabbits	No signs of irritation in rinsed eyes; 2 unrinsed eyes had slight erythema for 24 h after instillation; mean score = 0.1 at 24, 48, and 72 h	3
Silica (hydrophobic); 100 mg instilled	8 rabbits; no further details	Ocular irritation study; eyes not rinsed in 5 rabbits; eyes rinsed after 5 min in 3 rabbits	No signs of irritation	3
Silica (hydrophobic); 100 mg instilled	9 rabbits; no further details	Ocular irritation study; eyes not rinsed in 6 rabbits; eyes rinsed after 4 sec in 3 rabbits	No signs of irritation	3
Silica (hydrophilic); 100 mg instilled	8 rabbits; no further details	Ocular irritation study; eyes not rinsed in 5 rabbits; eyes rinsed in 3 rabbits after 5 min	No signs of irritation	3
Silica (hydrophilic); 100 mg instilled	9 rabbits; no further details	Ocular irritation study; eyes not rinsed in 6 rabbits; eyes rinsed after 30 sec in 3 rabbits	No signs of irritation in rinsed eyes; mean score 0.15; very slight conjunctival erythema up to 48 h	3

REFERENCES

1. Nikitakis J, Lange B. wINCI: International Cosmetic Ingredient Dictionary and Handbook. <http://webdictionary.personalcarecouncil.org/jsp/Home.jsp>. Washington, DC: Personal Care Products Council. Last Updated: 2019. Accessed: 4/5/2018.
2. OECD SIDS. Synthetic amorphous silica and silicates. Berlin, Germany 2004. <https://hpvchemicals.oecd.org/UI/handler.axd?id=4c05aa97-50de-4090-a1cb-70a5e8ed2c8d>. Pages 1-254.
3. European Centre for Ecotoxicology and Toxicology of Chemicals (ECETOC). Synthetic Amorphous Silica (CAS No. 7631-86-9). Brussels 2006. JACC No. 51. <http://www.ecetoc.org/wp-content/uploads/2014/08/JACC-051.pdf>. Pages 1-237.
4. Heppleston A. The fibrogenic action of silica. *Br Med Bull*. 1969;25(3):282-287.
5. Becker L, Bergfeld W, Belsito D, et al. 2009. Safety Assessment of Silica and Related Cosmetic Ingredients. Review CI, ed.
6. The Synthetic Amorphous Silica and Silicates Industry Association. 2008. Nanoscale Materials Stewardship Program (NMSPP) Voluntary Submittal Package for Synthetic Amorphous Silica. Washington, DC. Submitted to CIR by the Synthetic Amorphous Silica and Silicate Industry Association on March 11, 2019
7. Arts J, Muijsers H, Duistermaat E, Junker K, Kuper C. Five-day inhalation toxicity study of three types of synthetic amorphous silicas in Wistar rats and post-exposure evaluations for up to 3 months. *Food Chem Toxicol*. 2007;45(10):1856-1867.
8. Lewinson J, Mayr W, Wagner H. Characterization and toxicological behavior of synthetic amorphous hydrophobic silica. *Regul Toxicol Pharmacol*. 1994;20(1 Pt 1):37-57.
9. National Institute for Occupational Safety and Health (NIOSH). NIOSH Pocket Guide to Chemical Hazards: Silica, amorphous. <https://www.cdc.gov/niosh/npg/npgd0552.html>. Last Updated: 2018. Accessed: 11/1/2018.
10. U. S. Department of Labor. Silica, Amorphous, Precipitated and Gel. https://www.osha.gov/dts/chemicalsampling/data/CH_266700.html. Last Updated: 2018. Accessed: 6/1/2018.
11. Pavlich D. 2019. Comments from the Synthetic Amorphous Silica and Silicate Industry Association to Cosmetic Ingredient Review. Unpublished data submitted to CIR by the Synthetic Amorphous Silica and Silicate Industry Association on March 11, 2019
12. Council of Experts, United States Pharmacopeial Convention. *Food Chemicals Codex*. 8th ed. Rockville, MD: United States Pharmacopeia (USP); 2012.
13. Byers P, Gage J. The toxicity of precipitated silica. *Brit J Industr Med*. 1961;18(4):295-302.
14. Gray C, Muranko H. Studies of robustness of industrial aciniform aggregates and agglomerates - carbon black and amorphous silicas: A review amplified by new data. *JOEM*. 2006;48(12):1279-1290.

15. Yates D, Healy T. The structure of the silica/electrolyte interface. *J Colloid Interface Sci.* 1976;55(1):9-19.
16. Hurd A, Flower W. In situ growth and structure of fractal silica aggregates in a flame. *J Colloid Interface Sci.* 1988;122(1):178.
17. U.S. Pharmacopeial Convention. *Food Chemicals Codex*. 8th ed. Baltimore, MD: United Book Press, Inc.; 2012.
18. U.S. Food and Drug Administration Center for Food Safety & Applied Nutrition (CFSAN). Voluntary Cosmetic Registration Program - Frequency of Use of Cosmetic Ingredients. College Park, MD 2019 2019. (Obtained under the Freedom of Information Act from CFSAN; requested as "Frequency of Use Data" January 3, 2019; received February 13, 2019.)
19. Personal Care Products Council. 2018. Council Concentration of Use Survey: Silica Ingredients. Unpublished data submitted by Personal Care Products Council on October 26, 2018.
20. Rothe H, Fautz R, Gerber E, et al. Special aspects of cosmetic spray safety evaluations: Principles on inhalation risk assessment. *Toxicol Lett.* 2011;205(2):97-104.
21. Rothe H. Special Aspects of Cosmetic Spray Evaluation. Unpublished data presented at the 26 September CIR Expert Panel meeting. Washington, D.C.
22. Bremmer H, Prud'homme de Lodder L, Engelen J. Cosmetics Fact Sheet: To assess the risks for the consumer; Updated version for ConsExpo 4. Bilthoven, Netherlands 2006 2006. RIVM 320104001/2006. <http://www.rivm.nl/bibliotheek/rapporten/320104001.pdf>. Accessed 8/24/2011. Pages 1-77.
23. Johnsen M. The Influence of Particle Size. *Spray Technology and Marketing.* 2004;14(11):24-27.
24. CIR Science and Support Committee of the Personal Care Products Council (CIR SSC). 2015. Cosmetic Powder Exposure. Unpublished data submitted by the Personal Care Products Council.
25. Aylott R, Byrne G, Middleton J, Roberts M. Normal use levels of respirable cosmetic talc: Preliminary study. *Int J Cosmet Sci.* 1976;1(3):177-186.
26. Russell R, Merz R, Sherman W, Siverston J. The determination of respirable particles in talcum powder. *Food Cosmet Toxicol.* 1979;17(2):117-122.
27. Regulation (EC) No. 1223/2009 of the European Parliament and of the Council of 30 November 2009 on Cosmetic Products., (2009).
28. Australian Government Department of Health. National Industrial Chemicals Notification and Assessment Scheme (NICNAS). <https://www.nicnas.gov.au/chemical-information>. Last Updated: Accessed: 5/1/2018.
29. Kaewamatawong T, Kawamura N, Okajima M, Sawada M, Morita T, Shimada A. Acute pulmonary toxicity caused by exposure to colloidal silica: Particle size dependent pathological changes in mice. *Toxicol Pathol.* 2005;33(7):743-749.

30. Javadzadeh Y, Jafari-Navimipour B, Nokhodchi A. Liquesolid technique for dissolution rate enhancement of a high dose water-insoluble drug (carbamazepine). *Int J Pharm.* 2007;341(1-2):26-34.
31. Villota R, Hawkes J. Food applications and the toxicological and nutritional implications of amorphous silicon dioxide. *Crit Rev Food Sci Nutr.* 1986;23(4):289-321.
32. Sauer F, Laughland D, Davidson W. Silica metabolism in guinea pigs. *Can J Biochem Physiol.* 1959;37(2):183-191.
33. Sauer F, Laughland D, Davidson W. The silica content of guinea pig tissues as determined by chemical and isotopic techniques. *Can J Biochem Physiol.* 1959;37(10):1173-1181.
34. Newberne P, Wilson R. Renal damage associated with silicon compounds in dogs. *Proc Natl Acad Sci USA.* 1970;65(4):872-875.
35. Takizawa Y, Hirasawa F, Noritomi E, Aida M, Tsunoda H, Uesugi S. Oral ingestion of syloid to mice and rats and its chronic toxicity and carcinogenicity. *Acta Medica et Biologica.* 1988;36(1):27-56.
36. W.R. Grace & Co. 1981. Supplement to GRAS affirmation petition No. 1G0270: Silica gel for use as a carrier for flavors. Submitted by the US FDA in response to a FOI request. 189 pages.
37. Low R, Absher P, Hemenway D, Giancola M. Bronchoalveolar lavage lipids in rats exposed to aerosolized silicon dioxide polymers. *Am Rev Resp Dis.* 1985;13:183.
38. Hemenway D, Abasher M, Landesman M, Trombley L, Emerson R. Differential lung response following silicon dioxide polymorph aerosol exposure. In: DF G, ed. *Silica, Silicosis and Cancer.* NY: Praeger Publ; 1986:105-116.
39. Warheit D, Carakostas M, Kelly D, Hardky M. Four-week inhalation toxicity study with Ludox colloidal silica in rats: Pulmonary cellular responses. *Fundam Appl Toxicol.* 1991;16(3):590-601.
40. Warheit D, Achinko L, Carakostas M, Hartsky M. Testing the efficacy of biomarkers to predict pulmonary toxicity of inhaled materials. *Am Rev Resp Dis.* 1990;141A:419.
41. Lee K, Kelly D. Translocation of particle-laden alveolar macrophages and intra-alveolar granuloma formation in rats exposed to Ludox colloidal amorphous silica by inhalation. *Toxicol.* 1993;77(3):205-222.
42. Warheit D, McHugh T, Hartsky M. Differential pulmonary responses in rats inhaling crystalline, colloidal, or amorphous silica dusts. *Scand J Work Environ Health.* 1995;21(Suppl 2):19-21.
43. Reuzel P, Bruhijntjes J, Reron V, Woutersen R. Subchronic inhalation toxicity of amorphous silicas and quartz dust in rats. *Fd Chem Toxic.* 1991;29(5):341-354.
44. Shin J, Jeon K, Kim J, et al. Subacute inhalation toxicity study of synthetic amorphous silica nanoparticles in Sprague-Dawley rats. *Inhal Toxicol.* 2017;29(12-14):567-576.
45. Johnston C, Driscoll K, Finkelstein J, et al. Pulmonary chemokine and mutagenic responses in rats after subchronic inhalation or amorphous and crystalline silica. *Toxicol Sci.* 2000;56(2):405-413.

46. Schepers G. Hypertension due to inhaled submicron amorphous silica. *Toxicol App Pharmacol.* 1959;1(5):487-500.
47. Schepers G, Durkan T, Delahant A, Creedon F, Redlin A. The biological action of Degussa submicron amorphous silica dust (Dow Corning Silica). I. Inhalation studies in rats. *AMA Arch Ind Health.* 1957;16(2):125-146.
48. Schepers G. Biological action of precipitation-process submicron amorphous silica (HI-SIL 233). In: DD D, ed. *Health Effects of Synthetic Silica Particulates, ASTM STP 732.* American Society for Testing and Materials; 1981:144-173.
49. Groth D, Moormann W, Lynch D, Stettler L, Wagner W, Hornung R. Chronic effects of inhaled amorphous silicas in animals. In: DD D, ed. *Health Effects of Synthetic Silica Particulates, ASTM STP 732.* American Society for Testing and Materials; 1981:118-143.
50. Schepers G, Durkan T, Delahant A, Creedon F, Redlin A. The biological action of inhaled Degussa submicron amorphous silica dust (Dow Corning Silica): II. The pulmonary reaction in uninfected guinea pigs. *AMA Arch Ind Health.* 1957;16(3):203-224.
51. Schepers G, Delahant A, Schmidt J, Von Wecheln J, Creedon F, Clark R. The biological action of Degussa submicron amorphous silica dust (Dow Corning Silica): III. Inhalation studies in rabbits. *AMA Arch Ind Health.* 1957;16(4):280-301.
52. Schepers G. Reaction of monkey lung to siliceous dust. *Arch Environ Health.* 1962;5(4):278-299.
53. Kanematsu N, Hara M, Kada T. Rec assay and mutagenicity studies on metal compounds. *Mutat Res.* 1980;77(2):109-116.
54. Prival M, Simmon V, Mortelmans K. Bacterial mutagenicity testing of 49 food ingredients gives very few positive results. *Mut Res.* 1991;260(4):321-329.
55. Liu X, Keane M, Zhong B-Z, Ong T, Wallace W. Micronucleus formation in V79 cells treated with respirable silica dispersed in medium and in simulated pulmonary surfactant. *Mutat Res.* 1996;361(2-3):89-94.
56. Zhong B, Ong T, Whong W. Studies on the relationship between treatment conditions and micronucleus induction in V79 cells exposed to silica and glass fiber. *Mutat Res.* 1997;391(1-2):111-116.
57. U.S. Food and Drug Administration (FDA). Mutagenic evaluation of compound FDA 71-48, silica aerogel. Unpublished report 2446 by Litton Bionetics, Kensington, MD. Washington, DC: Food and Drug Administration;1974. FDABF-GRAS-311. <https://ntrl.ntis.gov/NTRL/dashboard/searchResults/titleDetail/PB245467.xhtml>.
58. International Agency for Research on Cancer (IARC). 1997. Silica, Some Silicates, Coal Dust and *para*-Aramid Fibrils. Vol 68. Lyon, France: World Health Organization.
59. Campbell J. Effects of precipitated silica and of iron oxide on the incidence of primary lung tumours in mice. *Brit Med J.* 1940;2(4156):275-280.
60. Pott F, Roller M. Carcinogenicity study with nineteen granular dusts in rats. *Eur J Oncol.* 2005;10(4):249-281.

61. Epstein W, Skahen J, Krasnobrod H. The organized epithelioid cell granuloma: Differentiation of allergic (zirconium) from colloidal (silica) types. *Amer J Path.* 1963;43(3):391-405.
62. Anonymous. 1984. Safety data of hydrated silica - contact allergenicity (Translated into English in 2009). Unpublished data submitted by the Personal Care Products Council
63. KGL Inc. 2003. An evaluation of the contact-sensitization potential of a topical coded product (facial mask containing 17% Hydrated Silica) in human skin by means of the maximization assay. KGL Protocol #5384. Unpublished data submitted by the Personal Care Products Council.
64. KGL Inc. 2004. An evaluation of the contact-sensitization potential of a topical coded product (face powder containing 21.7436% Silica) in human skin by means of the maximization assay. KGL Protocol #5632. Unpublished data submitted by the Personal Care Products Council.
65. Hazelton Laboratories. 1958. Progress Report No. 1; Acute oral administration, acute eye application. Submitted by EPA in response to a FOI request in 2008. 66 pages.
66. Plunkett E, DeWitt B. Occupational exposure to Hil-Sil and Silene: Report of an 18-year study. *Arch Environ Health.* 1962;5(5):469-472.
67. Wilson R, Stevens P, Lovejoy H, Bell Z, Richie R. Effects of chronic amorphous silica exposure on sequential pulmonary functions. *J Occup Med.* 1979;21(6):399-402.
68. Choudat D, Frisch C, Barrat G, El Kholt iA, Conso F. Occupational exposure to amorphous silica dust and pulmonary function. *Br J Indust Med.* 1990;47(11):763-766.
69. Volk H. The health of workers in a plant making highly dispersed silica. *Arch Environ Health.* 1960;1(2):125-128.

2021 FDA VCRP Raw Data

ALUMINUM CALCIUM SODIUM SILICATE	Eyeliners	5
ALUMINUM CALCIUM SODIUM SILICATE	Eye Shadow	5
ALUMINUM CALCIUM SODIUM SILICATE	Other Fragrance Preparation	1
ALUMINUM CALCIUM SODIUM SILICATE	Hair Conditioner	2
ALUMINUM CALCIUM SODIUM SILICATE	Tonics, Dressings, and Other Hair Grooming Aids	1
ALUMINUM CALCIUM SODIUM SILICATE	Blushers (all types)	4
ALUMINUM CALCIUM SODIUM SILICATE	Foundations	1
ALUMINUM CALCIUM SODIUM SILICATE	Lipstick	59
ALUMINUM CALCIUM SODIUM SILICATE	Other Makeup Preparations	7
ALUMINUM CALCIUM SODIUM SILICATE	Nail Polish and Enamel	8
ALUMINUM CALCIUM SODIUM SILICATE	Body and Hand (exc shave)	1
ALUMINUM CALCIUM SODIUM SILICATE	Moisturizing	8
ALUMINUM CALCIUM SODIUM SILICATE	Other Skin Care Preps	1
ALUMINUM SILICATE	Tonics, Dressings, and Other Hair Grooming Aids	1
ALUMINUM SILICATE	Hair Color Sprays (aerosol)	1
ALUMINUM SILICATE	Other Hair Coloring Preparation	1
ALUMINUM SILICATE	Blushers (all types)	1
ALUMINUM SILICATE	Moisturizing	1
AMMONIUM SILVER ZINC ALUMINUM SILICATE	Eye Shadow	19
AMMONIUM SILVER ZINC ALUMINUM SILICATE	Blushers (all types)	4
AMMONIUM SILVER ZINC ALUMINUM SILICATE	Face Powders	2
AMMONIUM SILVER ZINC ALUMINUM SILICATE	Foundations	1
AMMONIUM SILVER ZINC ALUMINUM SILICATE	Other Makeup Preparations	1
CALCIUM SILICATE	Eyeliners	1
CALCIUM SILICATE	Eye Shadow	1
CALCIUM SILICATE	Powders (dusting and talcum, excluding aftershave talc)	2
CALCIUM SILICATE	Blushers (all types)	4
CALCIUM SILICATE	Face Powders	14
CALCIUM SILICATE	Foundations	1
CALCIUM SILICATE	Makeup Bases	1
CALCIUM SILICATE	Other Makeup Preparations	1
CALCIUM SILICATE	Cleansing	1
CALCIUM SILICATE	Face and Neck (exc shave)	1
CALCIUM SILICATE	Moisturizing	1
LITHIUM MAGNESIUM SILICATE	Face and Neck (exc shave)	1
LITHIUM MAGNESIUM SODIUM SILICATE	Eyeliners	10

LITHIUM MAGNESIUM SODIUM SILICATE	Mascara	1
LITHIUM MAGNESIUM SODIUM SILICATE	Other Eye Makeup Preparations	2
LITHIUM MAGNESIUM SODIUM SILICATE	Face Powders	1
LITHIUM MAGNESIUM SODIUM SILICATE	Foundations	32
LITHIUM MAGNESIUM SODIUM SILICATE	Lipstick	46
LITHIUM MAGNESIUM SODIUM SILICATE	Nail Polish and Enamel	2
LITHIUM MAGNESIUM SODIUM SILICATE	Cleansing	1
LITHIUM MAGNESIUM SODIUM SILICATE	Moisturizing	1
LITHIUM MAGNESIUM SODIUM SILICATE	Paste Masks (mud packs)	1
MAGNESIUM ALUMINOMETASILICATE	Eye Shadow	1
MAGNESIUM ALUMINOMETASILICATE	Mascara	1
MAGNESIUM ALUMINOMETASILICATE	Foundations	16
MAGNESIUM ALUMINOMETASILICATE	Makeup Bases	1
MAGNESIUM ALUMINOMETASILICATE	Face and Neck (exc shave)	1
MAGNESIUM ALUMINOMETASILICATE	Moisturizing	1
MAGNESIUM ALUMINOMETASILICATE	Paste Masks (mud packs)	1
MAGNESIUM ALUMINUM SILICATE	Baby Lotions, Oils, Powders, and Creams	4
MAGNESIUM ALUMINUM SILICATE	Eyebrow Pencil	6
MAGNESIUM ALUMINUM SILICATE	Eyeliners	31
MAGNESIUM ALUMINUM SILICATE	Eye Shadow	10
MAGNESIUM ALUMINUM SILICATE	Eye Lotion	7
MAGNESIUM ALUMINUM SILICATE	Mascara	12
MAGNESIUM ALUMINUM SILICATE	Other Eye Makeup Preparations	6
MAGNESIUM ALUMINUM SILICATE	Hair Conditioner	3
MAGNESIUM ALUMINUM SILICATE	Shampoos (non-coloring)	3
MAGNESIUM ALUMINUM SILICATE	Tonics, Dressings, and Other Hair Grooming Aids	3
MAGNESIUM ALUMINUM SILICATE	Hair Tints	1
MAGNESIUM ALUMINUM SILICATE	Blushers (all types)	5
MAGNESIUM ALUMINUM SILICATE	Face Powders	7
MAGNESIUM ALUMINUM SILICATE	Foundations	22
MAGNESIUM ALUMINUM SILICATE	Leg and Body Paints	1
MAGNESIUM ALUMINUM SILICATE	Lipstick	1
MAGNESIUM ALUMINUM SILICATE	Makeup Bases	8
MAGNESIUM ALUMINUM SILICATE	Other Makeup Preparations	7
MAGNESIUM ALUMINUM SILICATE	Bath Soaps and Detergents	1
MAGNESIUM ALUMINUM SILICATE	Deodorants (underarm)	2
MAGNESIUM ALUMINUM SILICATE	Other Personal Cleanliness Products	7
MAGNESIUM ALUMINUM SILICATE	Aftershave Lotion	4
MAGNESIUM ALUMINUM SILICATE	Shaving Cream	1
MAGNESIUM ALUMINUM SILICATE	Other Shaving Preparation Products	1
MAGNESIUM ALUMINUM SILICATE	Cleansing	28
MAGNESIUM ALUMINUM SILICATE	Face and Neck (exc shave)	50
MAGNESIUM ALUMINUM SILICATE	Body and Hand (exc shave)	32

MAGNESIUM ALUMINUM SILICATE	Moisturizing	49
MAGNESIUM ALUMINUM SILICATE	Night	10
MAGNESIUM ALUMINUM SILICATE	Paste Masks (mud packs)	35
MAGNESIUM ALUMINUM SILICATE	Skin Fresheners	1
MAGNESIUM ALUMINUM SILICATE	Other Skin Care Preps	21
MAGNESIUM ALUMINUM SILICATE	Suntan Gels, Creams, and Liquids	1
MAGNESIUM ALUMINUM SILICATE	Indoor Tanning Preparations	3
MAGNESIUM SILICATE	Eyeliners	6
MAGNESIUM SILICATE	Eye Shadow	7
MAGNESIUM SILICATE	Mascara	1
MAGNESIUM SILICATE	Blushers (all types)	1
MAGNESIUM SILICATE	Face Powders	5
MAGNESIUM SILICATE	Foundations	3
MAGNESIUM SILICATE	Lipstick	5
MAGNESIUM SILICATE	Other Makeup Preparations	7
MAGNESIUM SILICATE	Nail Polish and Enamel	1
MAGNESIUM SILICATE	Face and Neck (exc shave)	2
MAGNESIUM SILICATE	Moisturizing	1
MAGNESIUM SILICATE	Paste Masks (mud packs)	2
MAGNESIUM SILICATE	Other Skin Care Preps	1
POTASSIUM SILICATE	Paste Masks (mud packs)	1
SODIUM MAGNESIUM SILICATE	Bath Capsules	1
SODIUM MAGNESIUM SILICATE	Eyebrow Pencil	1
SODIUM MAGNESIUM SILICATE	Eyeliners	2
SODIUM MAGNESIUM SILICATE	Eye Shadow	7
SODIUM MAGNESIUM SILICATE	Mascara	2
SODIUM MAGNESIUM SILICATE	Other Eye Makeup Preparations	1
SODIUM MAGNESIUM SILICATE	Blushers (all types)	4
SODIUM MAGNESIUM SILICATE	Face Powders	7
SODIUM MAGNESIUM SILICATE	Foundations	1
SODIUM MAGNESIUM SILICATE	Leg and Body Paints	1
SODIUM MAGNESIUM SILICATE	Lipstick	17
SODIUM MAGNESIUM SILICATE	Rouges	1
SODIUM MAGNESIUM SILICATE	Other Makeup Preparations	4
SODIUM MAGNESIUM SILICATE	Other Oral Hygiene Products	1
SODIUM MAGNESIUM SILICATE	Bath Soaps and Detergents	1
SODIUM MAGNESIUM SILICATE	Cleansing	3
SODIUM MAGNESIUM SILICATE	Depilatories	1
SODIUM MAGNESIUM SILICATE	Face and Neck (exc shave)	4
SODIUM MAGNESIUM SILICATE	Moisturizing	1
SODIUM MAGNESIUM SILICATE	Paste Masks (mud packs)	1
SODIUM MAGNESIUM SILICATE	Other Skin Care Preps	2

SODIUM METASILICATE	Tonics, Dressings, and Other Hair Grooming Aids	1
SODIUM METASILICATE	Other Hair Preparations	2
SODIUM METASILICATE	Hair Dyes and Colors	36
SODIUM METASILICATE	Hair Lighteners with Color	2
SODIUM METASILICATE	Hair Bleaches	20
SODIUM METASILICATE	Other Hair Coloring Preparation	1
SODIUM METASILICATE	Face and Neck (exc shave)	1
SODIUM POTASSIUM ALUMINUM SILICATE	Eye Shadow	1
SODIUM POTASSIUM ALUMINUM SILICATE	Blushers (all types)	2
SODIUM POTASSIUM ALUMINUM SILICATE	Face Powders	1
SODIUM POTASSIUM ALUMINUM SILICATE	Foundations	2
SODIUM POTASSIUM ALUMINUM SILICATE	Lipstick	9
SODIUM POTASSIUM ALUMINUM SILICATE	Rouges	3
SODIUM POTASSIUM ALUMINUM SILICATE	Other Makeup Preparations	2
SODIUM POTASSIUM ALUMINUM SILICATE	Moisturizing	9
SODIUM POTASSIUM ALUMINUM SILICATE	Other Skin Care Preps	2
SODIUM SILICATE	Eye Lotion	2
SODIUM SILICATE	Other Eye Makeup Preparations	5
SODIUM SILICATE	Other Hair Preparations	2
SODIUM SILICATE	Hair Dyes and Colors	6
SODIUM SILICATE	Hair Lighteners with Color	3
SODIUM SILICATE	Hair Bleaches	13
SODIUM SILICATE	Other Hair Coloring Preparation	2
SODIUM SILICATE	Dentifrices	1
SODIUM SILICATE	Other Oral Hygiene Products	1
SODIUM SILICATE	Other Personal Cleanliness Products	1
SODIUM SILICATE	Shaving Cream	2
SODIUM SILICATE	Depilatories	12
SODIUM SILICATE	Face and Neck (exc shave)	2
SODIUM SILICATE	Skin Fresheners	1
SODIUM SILICATE	Other Skin Care Preps	2



Memorandum

TO: Bart Heldreth, Ph.D.
Executive Director - Cosmetic Ingredient Review

FROM: Carol Eisenmann, Ph.D.
Personal Care Products Council

DATE: October 15, 2020

SUBJECT: Magnesium Aluminum Silicate

Anonymous. 2020. Magnesium Aluminum Silicate: Origin and composition and impurities.

October 2020

Magnesium Aluminum Silicate

Origin: The Magnesium Aluminum Silicate discussed herein is natural and obtained via mining. It is not synthetic. The material undergoes several processing steps, including washing, drying and milling in order to produce a product with uniform characteristics.

Composition and Impurities: The product consists of 100% Magnesium Aluminum Silicate. Four discrete lots of product were tested for the presence of crystalline silica. In each case, the result was non-detectable (limit of detection = 0.1%).



Memorandum

TO: Bart Heldreth, Ph.D.
Executive Director - Cosmetic Ingredient Review

FROM: Carol Eisenmann, Ph.D.
Personal Care Products Council

DATE: October 15, 2020

SUBJECT: Aluminum Calcium Sodium Silicate

Anonymous. 2020. Statement Regarding Crystallinity of Aluminum Calcium Sodium Silicate.

October 2020

Statement Regarding Crystallinity of Aluminum Calcium Sodium Silicate

The Aluminum Calcium Sodium Silicate used in our trade name mixtures sold to the cosmetics industry is amorphous and does not contain crystalline silica.



Memorandum

TO: Bart Heldreth, Ph.D.
Executive Director - Cosmetic Ingredient Review

FROM: Carol Eisenmann, Ph.D.
Personal Care Products Council

DATE: October 26, 2020

SUBJECT: Aluminum Calcium Sodium Silicate

Anonymous. 2020. Aluminum Calcium Sodium Silicate.

October 2020

Aluminum Calcium Sodium Silicate

A supplier reports that an XRD study reveals that Aluminum Calcium Sodium Silicate sold by their company does not contain “crystalline silica” and is amorphous aluminum silicate. (the specific peak of “cristobalite” and “quartz” in XRD, appear around at 22 degree and at 21/27 degree, respectively, however, there is no peak identified)

Composition is SiO₂ 53.6%, Al₂O₃ 29.4%, Na₂O 8.3%, CaO 8.3%



Memorandum

TO: Bart Heldreth, Ph.D.
Executive Director - Cosmetic Ingredient Review

FROM: Carol Eisenmann, Ph.D.
Personal Care Products Council

DATE: November 5, 2020

SUBJECT: Sodium Magnesium Silicate

Mizusawa Industrial Chemicals, Ltd. 2020. Product information Ionite (Sodium magnesium silicate).

**Mizusawa
Industrial
Chemicals, Ltd.**



Head Office

1-5-9, Nihonbashi-honcho, Chuo-ku,
Tokyo 103-0023, Japan
Phone: +81-3-3270-2051
Fax : +81-3-5201-7466

November 5th, 2020

To : Personal Care Products Council

We show below our product information.

- | | |
|----------------------------|--|
| • Name of products | Ionite |
| • Substance | Sodium magnesium silicate |
| • CAS No. | 25321-62-4 |
| • Raw materials | All raw materials are synthetic products. |
| • Composition | SiO ₂ 59.0%, MgO 28.0%, Na ₂ O 4.0% |
| • Impurities | None (100% pure) |
| • Crystalline silica | None (by XRD qualitative analysis) |
| • Inhalation toxicity data | No data |
| • Production process | Ionite is hydrothermally synthesized from Si source,
Na source and Mg source. |

Mizusawa Industrial Chemicals, Ltd.

Nobuyuki Iwasaki

Nobuyuki Iwasaki

General Manager

Safety & Quality Assurance Control Dept.



Memorandum

TO: Bart Heldreth, Ph.D.
Executive Director - Cosmetic Ingredient Review

FROM: Carol Eisenmann, Ph.D.
Personal Care Products Council

DATE: November 13, 2020

SUBJECT: Sodium Silver Aluminum Silicate

Anonymous. 2020. Sodium Silver Aluminum Silicate: Crystallinity.

November 2020

Sodium Silver Aluminum Silicate

Sodium silicate (Amorphous silica salt) is used for manufacturing Sodium Silver Aluminum Silicate. Neither the raw material nor the final product contains crystalline silica as an impurity.

Additional information on the method of manufacture of Sodium Silver Aluminum Silicate were provided in July 2019..



**Synthetic Amorphous Silica
and Silicate Industry Association**

Cosmetic Ingredient Review
1620 L St. N. W. Suite 1200
Washington D. C. 20036

December 1, 2020

Dr. Bart Heldreth, Ph.D., Executive Director, CIR

Comments from the
Synthetic Amorphous Silica and Silicate Industry Association
To
Cosmetic Ingredient Review
Dr. Bart Heldreth, Director and the Expert Panel
on
Post Meeting Announcement

Cosmetic Ingredient Review Expert Panel 155th Meeting (September 14-15, 2020) - Findings

September 18, 2020

and

Amended Safety Assessment of

Silicates as Used in Cosmetics

August 21, 2020

Dear Dr. Heldreth,

In response to the Expert Panel's September 18, 2020 issuance of the "Post Meeting Announcement: Cosmetic Ingredient Review Expert Panel 155th Meeting (September 14-15, 2020) – Findings September 18, 2020 (Insufficient Data Announcement: Silicates) and Amended Safety Assessment of Silicates as Used in Cosmetics August 21, 2020", the members of the Synthetic Amorphous Silica and Silicate Industry Association (SASSI) would like to take this opportunity to advise the CIR Expert Panel that this time we have no additional data to submit related to the three silicates manufactured by SASSI member companies for use in cosmetics. As noted in our August 15, 2019 and September 12, 2019 letters, only calcium silicate, sodium metasilicate and sodium silicate are marketed to the cosmetic industry.

We are open to discussing any opportunity to assist CIR in completing a comprehensive and accurate review of synthetic amorphous silica and silicate ingredients. Please contact me to determine how we can support the efforts of your organization.

We look forward to your response.

Sincerely yours,

A handwritten signature in black ink that reads "David A. Pavlich". The signature is written in a cursive, flowing style.

David A. Pavlich
Association Manager
Synthetic Amorphous Silica and Silicate Industry
116 Countryside Drive
South Russell, OH 44022
440-897-8780



TO: Bart Heldreth Ph.D.
Executive Director – Cosmetic Ingredient Review

FROM: CIR Science and Support Committee of the Personal Care Products Council

DATE: October 29, 2020

SUBJECT: Amended Safety Assessment of Silicates as Used in Cosmetics

The CIR Science and Support Committee (CIR SSC) appreciates the opportunity to comment on the CIR report titled Amended Safety Assessment of Silicates as Used in Cosmetics.

The CIR report on silicate ingredients contains a wide range of ingredients that vary in the potential to contain low levels of crystalline silica as a contaminant. The maximum crystallinity reported (Magnesium and Calcium Silicates) is <0.2%, but these materials are reported as “not specifically marketed for cosmetic use”. For cosmetic ingredients for which information is available, levels of crystallinity are reported as <0.1%.

As in other CIR reports with a concern about potential trace contaminants, we believe that the CIR report on silicates should address contaminant concerns in the Discussion. The Discussion section of the silicate CIR report should make industry aware of the potential for contamination and the need to minimize exposure to unintentionally added crystalline silica.

We suggest the following language be included in the Discussion of the CIR report on silicates:

The Expert Panel for Cosmetic Ingredient Safety is concerned about the potential exposure to low concentrations of respirable crystalline silica from spray and powder products formulated with silicate ingredients. The concentrations of respirable crystalline silica potentially released by a cosmetic product should be controlled by using ingredients that contain little or no crystalline silica, limiting the concentration of the ingredient containing crystalline silica, and/or limiting the respirable particle fraction released by the product, consistent with Good Manufacturing Practices (GMPs).

If the Expert Panel wants to include an exposure limit in the Discussion, we suggest the following method based limit:

Using methods outlined in Rothe et al. (2011) for spray cosmetic products, and in Steiling et al. (2018) for powder cosmetic products, estimated exposure to respirable crystalline silica from spray and powder cosmetic products containing silicate ingredients should not exceed 3 $\mu\text{g}/\text{m}^3$. This limit is a chronic reference exposure level (REL) for respirable crystalline silica that was

developed following an analysis of occupational exposure studies to crystalline silica and the development of silicosis (OEHHA, 2005). Chronic RELs are designed to address continuous exposures for up to a lifetime.

Although we are suggesting the OEHHA REL of 3 $\mu\text{g}/\text{m}^3$ as the benchmark concentration, other values such as the OSHA Permissible Exposure Limit (PEL) of 50 $\mu\text{g}/\text{m}^3$ (OSHA, 2018) (a PEL is an 8-hour time-weighted exposure limit for occupational exposure), and urban ambient air levels of respirable crystalline silica of 0.25-2.87 $\mu\text{g}/\text{m}^3$ summarized by ATSDR (2019) may also be used.

REFERENCES

Agency for Toxic Substances and Disease Registry (ATSDR). 2019. Toxicological Profile for Silica. <https://www.atsdr.cdc.gov/toxprofiles/tp211.pdf>.

Occupational Safety and Health Administration (OSHA). 2018. OSHA Factsheet OSHA's Respirable Crystalline Silica Standard for General Industry and Maritime <https://www.osha.gov/Publications/OSHA3682.pdf>.

Office of Environmental Health Hazard Assessment (California) (OEHHA). 2005. Determination of Noncancer Chronic Reference Exposure Levels Chronic Toxicity summary— Silica (crystalline, respirable). <https://oehha.ca.gov/media/downloads/air/document/silicacrelfinal.pdf>.

Rothe H, Fautz R, Gerber E, et al. 2011. Special aspects of cosmetic spray safety evaluations: Principles on inhalation risk assessment. *Toxicol Lett*, 205: 97-104.

Steiling W, Almeida JF, Vandecasteele HA, et al. 2018. Principles for the safety evaluation of cosmetic powders. *Toxicol Lett*, 297: 8-18.